

Viefe[®]

**20
23**

**NEW
ERA OF
CON
TRAST**

 viefe.com



**Handles & knobs
catalogue**

Viefe[®]

—
**Handles & knobs
catalogue**

The new era of CONTRAST

CONTRAST

eng

Creating balanced contrasts

This catalogue is the culmination of a year's creativity and with which we'll open a new era at Vieve as regards design, new finishes, new materials and new product lines. We are defined by contrasts and they are the essence of the new collection which transmits informality, class and resounding simplicity. Sophisticated and practical, eclectic by nature, our exceptional products completely transform the usual user experience.

esp

Creamos contrastes en equilibrio

Este catálogo es la culminación de un año de creatividad. Con él abrimos una nueva era en Vieve, tanto por los diseños como por los nuevos acabados, materiales y líneas de productos. Los contrastes nos definen y son la esencia de esta nueva colección que transmite informalidad con clase y simplicidad contundente. Sofisticados y funcionales, eclécticos por naturaleza, nuestros productos excepcionales transforman las experiencias de uso habituales.

cat

Creem contrastos en equilibri

Aquest catàleg és la culminació d'un any de creativitat. Amb ell obrim una nova era a Vieve, tant pels dissenys com pels nous acabats, materials i línies de productes. Els contrastos ens defineixen i són l'essència d'aquesta nova col·lecció que transmet informalitat amb classe i simplicitat contundent. Sofisticats i funcionals, eclèctics per naturalesa, els nostres productes excepcionals transformen les experiències d'ús habituals.



FROM VIEFE *around the world*

eng ———

Singular products for plural tastes

Interior design professionals and architects from all around the world trust in our products for their projects, and of course individual customers. At Viefe they can find a wide variety of eclectic, decorative accessories which adapt to different tastes and lifestyles. Our designs transform all types of spaces and transmit the personality of whoever lives in that space.

esp —

Productos singulares para gustos plurales

Profesionales del interiorismo y la arquitectura de todo el mundo confían en nuestros productos para sus proyectos. Y también particulares, por supuesto. En Viefe encuentran una amplia variedad de complementos decorativos eclécticos que se adaptan a los diferentes gustos y estilos de vida. Nuestros diseños transforman todo tipo de espacios y transmiten la personalidad de quienes los habitan.

cat —

Productes singulars per a gustos plurals

Professionals de l'interiorisme i l'arquitectura de tot el món confien en els nostres productes per als seus projectes. I també particulars, és clar. A Viefe hi ha una àmplia varietat de complementos decoratius eclèctics que s'adapten als diferents gustos i estils de vida. Els nostres dissenys transformen tota mena d'espais i transmeten la personalitat dels qui hi habiten.

Designers that BREAK THE RULES

ALEXIS VIVET / Spain
BALUTTO ASSOCIATI / Italy
BERNAT LLONCH / Spain
HÉCTOR DIEGO / Spain
FRANK PERSON / Germany
KASCHKASCH / Germany
ORIOI BARRI / Spain
PATRICIA ROIG / Spain
SUNG SOOK KIM / South Korea & Italy
TERUEL-PARÉ / Spain
ULI BUDDE / Germany
2J DESIGN / USA
VIEFE STUDIO / Spain

eng _____

Creative collaborations across Europe with international designers

We collaborate with designers from all over the world who help us to give shape to our avant-garde products. Their restlessness and sensitivity to aesthetics leads us to readdress established design norms. With them by our side, we break the rules and we look for new ways to express ourselves which can be seen in our knobs, handles and other products. Together we innovate materials, reformulate finishes and create new trends. Their inspiration is an added impulse to us.

esp _____

Co-creamos desde Europa con diseñadores internacionales

Colaboramos con diseñadores de todo el mundo con los que damos forma a productos vanguardistas. Su inquietud y sensibilidad estética nos llevan a replantearnos lo establecido. A su lado rompemos las normas y buscamos nuevas formas de expresión plasmadas en pomos, tiradores y otros productos. Juntos innovamos en materiales, reformulamos acabados y creamos tendencia. Su inspiración es nuestro impulso.

cat _____

Co-creem des d'Europa amb dissenyadors internacionals

Col·laborem amb dissenyadors de tot el món amb els que donem forma a productes avantguardistes. La seva inquietud i sensibilitat estètica ens porten a replantejar-nos allò establert. Al seu costat tranquillem les normes i busquem noves formes d'expressió plasmades en poms, tiradors i altres productes. Junts innovem materials, reformulem acabats i creem tendència. La seva inspiració és el nostre impuls.

RESPECT *for the environment*

eng ———

Small steps for a great cause

We take the health of the planet very seriously as well as the impact of our manufacturing processes on the environment. Our policy of environmental awareness has led us to take measures over the years in order to be more sustainable. Since 2022 we have been working with 100% renewable energy sources and we have significantly modified the materials that we use for our packaging, opting for the use of paper over plastics and non-recyclable materials as far as possible. The ISO 14001 certifies our company as one which has below average carbon emissions.

esp ———

Pequeños pasos, una gran causa

Nos tomamos muy en serio la salud del planeta y el impacto de nuestros procesos en el entorno. Nuestra política de conciencia ambiental nos lleva a tomar medidas cada año para ser más sostenibles. Desde 2022 funcionamos 100% con energías renovables y hemos modificado significativamente los materiales de nuestro packaging para apostar por el papel y reducir al máximo el uso de plásticos no reciclados. La ISO 14001 nos avala como empresa con un índice de emisiones en CO2 por debajo de la media.

cat ———

Petits passos, una gran causa

Ens prenem molt seriosament la salut del planeta i l'impacte dels nostres processos a l'entorn. La nostra política de consciència ambiental ens porta a prendre mesures cada any per ser més sostenibles. Des del 2022 funcionem 100% amb energies renovables i hem modificat significativament els materials del nostre packaging per apostar pel paper i reduir al màxim l'ús de plàstics no reciclats. La ISO 14001 ens avala com a empresa amb un índex d'emissions de CO2 per sota de la mitjana.

—————
This is our HOME

Viefe[®]

OUR *Products*

**Nuestros
productos**

**Els nostres
productes**



0590

BELT

ZAMAK

Designer: Kaschkasch

NEW!



Finishes
Acabados

Matt white
Blanco mate

Matt black
Negro mate

Moss grey
Gris musgo

Green forest
Verde forest

Brown mocca
Marrón mocca

Red volcano
Rojo volcano

←→	o — o	Includes non-twisting tip <i>Incluye punta anti-giro</i>
63,5 mm	-	
221,3 mm	160 mm	

⊕
Technical info on page 256
Info técnica en pág 256



0590

BELT

ZAMAK

Designer: Kaschkasch

NEW!

Finishes Acabados

Matt white
Blanco mate

Matt black
Negro mate

Moss grey
Gris musgo

Green forest
Verde forest

Brown mocca
Marrón mocca

Red volcano
Rojo volcano

$\leftarrow \rightarrow$ 63,5 mm 221,3 mm	$\circ \text{---} \circ$ - 160 mm	Includes non-twisting tip <i>Incluye punta anti-giro</i>
---	---	---



⊕
 Technical info on page 256
Info técnica en pág 256



0597

PLIÉ

ZAMAK

Designer: Teruel & Paré

NEW!

Finishes
Acabados

Matt black
Negro mate

Metal grey
Gris metal

Metal brown
Marrón metal

←→	○ — ○
114 mm	64 mm
210 mm	160 mm



⊕
Technical info on page 256
Info técnica en pág 256



0600

WING

ALUMINIUM

Designer: Alexis Vivet

NEW!

Finishes <i>Acabados</i>	↳ — ↳	○ — ○ 1	○ — ○ 2
Stainless steel look <i>Inox look</i>	100 mm	64 mm	-
Brushed black <i>Negro cepillado</i>	200 mm	128 mm	-
Antique bronze <i>Bronce antiguo</i>	350 mm	256 mm	-
Brushed brass cava <i>Latón cava cepillado</i>	1200 mm	1120 mm	384 mm



⊕
Technical info on page 257
Info técnica en pág. 257

0600

WING

ALUMINIUM

Designer: Alexis Vivet

NEW!





0610

FLAPP

ALUMINIUM

Designer: Frank Person

NEW!

Finishes
Acabados

Stainless steel look
Inox look

Brushed black
Negro cepillado

Brushed brass cava
Latón cava cepillado

	←→	o — o 1	o — o 2
Stainless steel look <i>Inox look</i>	70 mm	32 mm	-
Brushed black <i>Negro cepillado</i>	200 mm	128 mm	160 mm
Brushed brass cava <i>Latón cava cepillado</i>	350 mm	256 mm	-
	1100 mm	416 mm	1056 mm



Technical info on page 258
Info técnica en pág 258





0610

FLAPP

ALUMINIUM

Designer: Frank Person

NEW!





0613

FLAPP

WOOD

Designer: Frank Person

NEW!



Finishes
Acabados

Oak
Roble

Walnut
Nogal

←→	o — o 1	o — o 2
70 mm	32 mm	-
200 mm	160 mm	-
1100 mm	1056 mm	416 mm



Technical info on page 258
Info técnica en pág 258



0613

FLAPP

WOOD

Designer: Frank Person

NEW!





0591

ETO

ALUMINIUM + WOOD

Designer: Kaschkasch

NEW!



Finishes
Acabados

Lava grey + Oak
Gris lava + roble

Lava grey + Walnut
Gris lava + Nogal

Matt black + Ash matt black lacquered
Negro mate + Fresno lacado negro mate

←→	o — o 1	o — o 2
174,6 mm	160 mm	-
334,6 mm	320 mm	-
1006,6 mm	992 mm	496 mm

⊕
Technical info on page 257
Info técnica en pág. 257



0591

ETO

ALUMINIUM + WOOD

Designer: Kaschkasch

NEW!



0601

OH!

WOOD

Designer: Alexis Vivet

NEW!

Finishes
Acabados

Oak
Roble

Walnut
Nogal

Ash matt black lacquered
Fresno lacado negro mate



40 mm



Technical info on page 259
Info técnica en pág 259



0601

OH!

ZAMAK

Designer: Alexis Vivet

NEW!

Finishes
Acabados

Brushed nickel
Níquel cepillado

Brushed brass cava
Latón cava cepillado

Matt black
Negro mate



40 mm



Technical info on page 259
Info técnica en pág 259



0602

VALLEY

ZAMAK

Designer: Alexis Vivet

NEW!

Finishes
Acabados

Polished black nickel
Níquel negro brillo

Polished brass
Latón brillo

Matt black
Negro mate

Brushed brass cava
Latón cava cepillado

K → I	o — o
223 mm	160 mm
330 mm	256 mm



⊕
Technical info on page 259
Info técnica en pág 259



0602

VALLEY

ZAMAK

Designer: Alexis Vivet

NEW!



Finishes
Acabados

Polished black nickel
Níquel negro brillo

Polished brass
Latón brillo

Matt black
Negro mate

Brushed brass cava
Latón cava cepillado

←→	o — o
223 mm	160 mm
330 mm	256 mm

⊕
Technical info on page 259
Info técnica en pág 259



0614

EQUIS

ZAMAK

Designer: Patricia Roig

NEW!



Finishes
Acabados

Polished chrome
Cromo brillo

Polished black nickel
Níquel negro brillo

Polished copper
Cobre brillo

Polished brass
Latón brillo

Matt white
Blanco mate

Matt black
Negro mate



40 mm



Technical info on page 262
Info técnica en pág 262



0604

PRISMA

ZAMAK

Designer: Alexis Vivet

NEW!



Finishes Acabados

Matt black
Negro mate

Rustic brass
Latón rústico

←→	o — o	Includes non-twisting tip <i>Incluye punta anti-giro</i>
78 mm	-	
272 mm	192 mm	



Technical info on page 260
Info técnica en pág 260



0608

QUART mini

ZAMAK

Designer: Frank Person

NEW!

Finishes Acabados

Brushed brass cava
Latón cava cepillado

Rustic brass
Latón rústico

Matt black
Negro mate

←→	o — o	
26 mm	-	Includes non-twisting tip <i>Incluye punta anti-giro</i>
146 mm	128 mm	



⊕
Technical info on page 260
Info técnica en pág 260



0616

QUART big

ZAMAK

Designer: Frank Person

NEW!



Finishes
Acabados

Brushed brass cava
Latón cava cepillado

Rustic brass
Latón rústico

Matt black
Negro mate

←→	o — o	Includes non-twisting tip <i>Incluye punta anti-giro</i>
33,8 mm	-	
183,4 mm	160 mm	

⊕
Technical info on page 260
Info técnica en pág 260



0588

ARPA PLATE

ALUMINIUM

Designer: Viefe Studio

NEW!

Finishes
Acabados

Rustic brass
Latón rústico

←→ | o — o

NEW! Ø 22 mm

70 mm -

230 mm 192 mm



Technical info on page 266
Info técnica en pág 266

0588

ARPA PLATE

ALUMINIUM

Designer: Viefe Studio

Finishes

Acabados

	←→	o — o 1	o — o 2
Stainless steel look <i>Inox look</i>	NEW! Ø 22 mm	-	-
	70 mm	-	-
Brushed brass <i>Latón cepillado</i>	230 mm	192 mm	-
	358 mm	320 mm	-
Brushed black <i>Negro cepillado</i>	1216 mm	1178 mm	589 mm



Technical info on page 266
Info técnica en pág 266

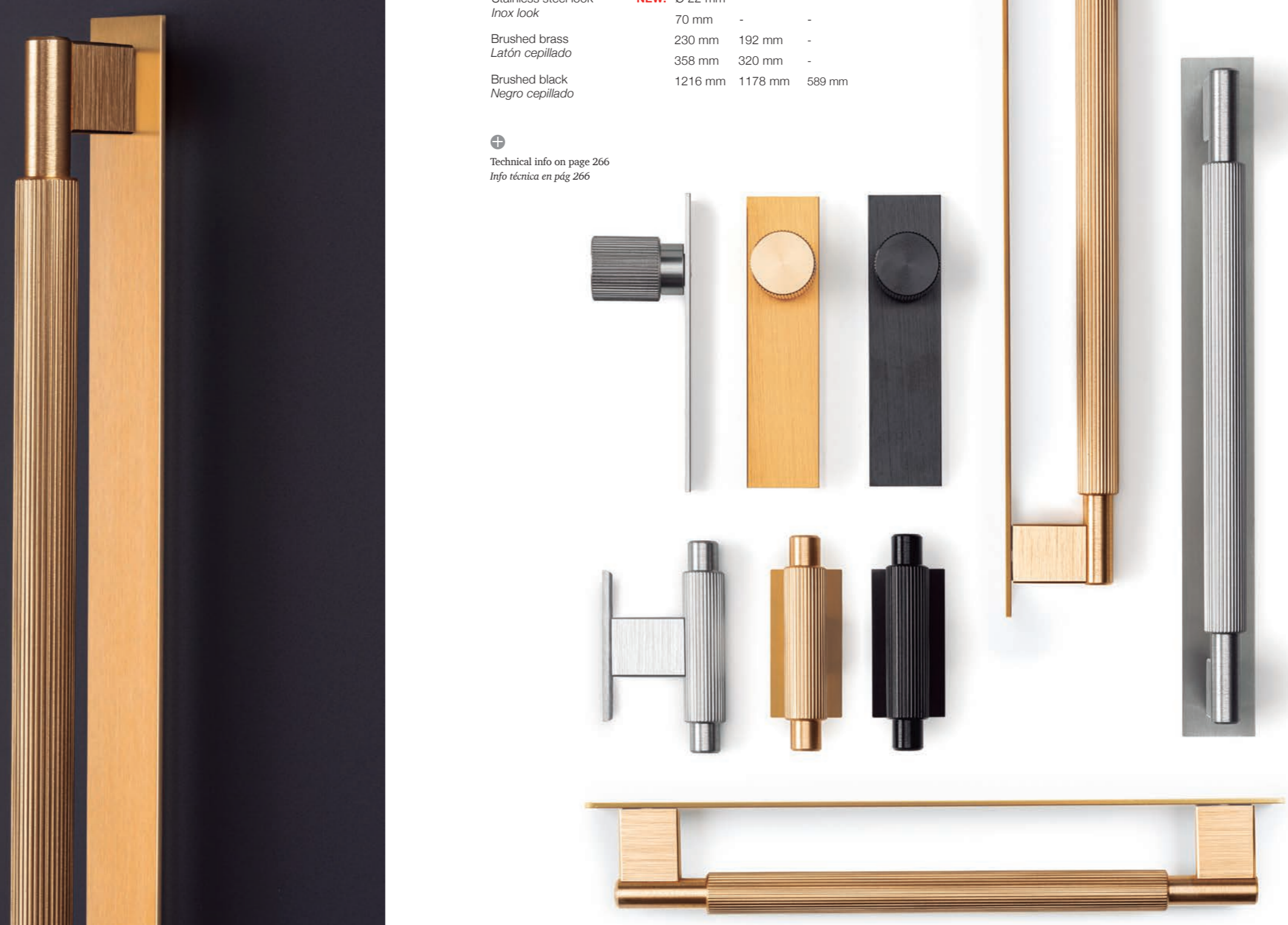



0583

ARPA

ALUMINIUM

Designer: Viefe Studio

NEW!

Finishes
Acabados

Rustic brass
Latón rústico

←→ | o — o

NEW! Ø 22 mm -
70 mm - Includes non-twisting tip
214 mm 192 mm *Incluye punta anti-giro*



⊕
Technical info on page 267
Info técnica en pág 267



0583

ARPA

ALUMINIUM

Designer: Viefe Studio

Finishes
Acabados

Stainless steel look
Inox look

Brushed brass
Latón cepillado

Brushed black
Negro cepillado

←→ | o — o 1 o — o 2

NEW! Ø 22 mm	-	-	
70 mm	-	-	Includes non-twisting tip <i>Incluye punta anti-giro</i>
214 mm	192 mm	-	
342 mm	320 mm	-	
1200 mm	1178 mm	589 mm	



⊕
Technical info on page 267
Info técnica en pág 267

0583

ARPA

ALUMINIUM

Designer: Viefe Studio





0506

FIRM

ZAMAK

Designer: Frank Person



Finishes
Acabados

Textured black
Negro texturizado

←→ | o — o

NEW!	45,8 mm	-	
	93,8 mm	64 mm	
NEW!	93,8 mm	64 mm	Cup pull / <i>Tirador concha</i>
	125,8 mm	96 mm	
	189,8 mm	160 mm	
	349,8 mm	320 mm	



Technical info on page 275
Info técnica en pág 275



0506

FIRM

ZAMAK

Designer: Frank Person

NEW!





0506

FIRM

ZAMAK

Designer: Frank Person

Finishes
Acabados

Textured black
Negro texturizado

←→ | o — o

NEW!	45,8 mm	-	
	93,8 mm	64 mm	
NEW!	93,8 mm	64 mm	Cup pull / <i>Tirador concha</i>
	125,8 mm	96 mm	
	189,8 mm	160 mm	
	349,8 mm	320 mm	



Technical info on page 275
Info técnica en pág 275



0528

RILLE

ALUMINIUM

Designer: Patricia Roig

Finishes
Acabados

Stainless steel look
Inox look

Brushed brass
Latón cepillado

Brushed black
Negro cepillado



←→	○ — ○ 1	○ — ○ 2
55 mm	-	-
190 mm	160 mm	
350 mm	320 mm	
510 mm	480 mm	
1022 mm	992 mm	496 mm

⊕
Technical info on page 261
Info técnica en pág 261



0528

RILLE

ALUMINIUM

Designer: Patricia Roig





0528

RILLE

ALUMINIUM

Designer: Patricia Roig

Finishes
Acabados

Stainless steel look
Inox look

Brushed brass
Latón cepillado

Brushed black
Negro cepillado

←→	o — o 1	o — o 2
55 mm	-	-
190 mm	160 mm	
350 mm	320 mm	
510 mm	480 mm	
1022 mm	992 mm	496 mm



Technical info on page 261
Info técnica en pág 261



0530

DISC

WOOD

Designer: Balutto Associati



Finishes
Acabados

Oak
Roble

Walnut
Nogal

Ash matt black lacquered
Fresno lacado negro mate



38 mm
50 mm



Technical info on page 262
Info técnica en pág 262



0530

DISC

ZAMAK

Designer: Balutto Associati



Finishes
Acabados

Brushed nickel
Níquel cepillado

NEW! Brushed brass cava
Latón cava cepillado

Matt white
Blanco mate

Matt black
Negro mate



38 mm

50 mm



Technical info on page 262
Info técnica en pág 262



0536

LUV

ZAMAK

Designer: Kaschkasch

Finishes
Acabados

	←→	o — o	
Brushed nickel <i>Níquel cepillado</i>	51,2 mm	-	Includes non-twisting tip <i>Incluye punta anti-giro</i>
NEW! Brushed brass cava <i>Latón cava cepillado</i>	202 mm	192 mm	
	330 mm	320 mm	
Matt white <i>Bianco mate</i>			
Matt black <i>Negro mate</i>			



Technical info on page 261
Info técnica en pág 261



0536

LUV

ZAMAK

Designer: Kaschkasch





0538

CONIC

WOOD

Designer: Kaschkasch



Finishes
Acabados

Oak
Roble

Walnut
Nogal

Ash matt black lacquered
Fresno lacado negro mate



29,4 mm

43 mm



Technical info on page 263
Info técnica en pág 263



0538

CONIC

ZAMAK

Designer: Kaschkasch



Finishes
Acabados

Matt white
Blanco mate

Matt black
Negro mate

Moss grey
Gris musgo



29,4 mm

43 mm



Technical info on page 263
Info técnica en pág 263



0542

FOLD

ZAMAK

Designer: Teruel & Paré

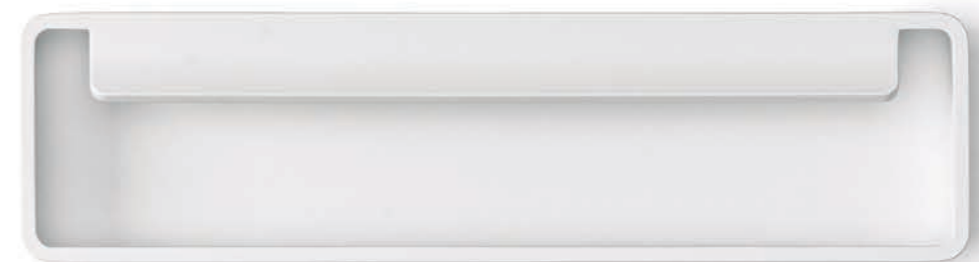

Finishes

Acabados

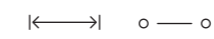

Brushed nickel
Níquel cepillado

174 mm 128 mm

NEW! Brushed brass cava
Latón cava cepillado

Matt white
Blanco mate

Matt black
Negro mate



Technical info on page 265
Info técnica en pág 265

0542

FOLD

ZAMAK

Designer: Teruel & Paré



Finishes
Acabados

Brushed nickel
Níquel cepillado

NEW! Brushed brass cava
Latón cava cepillado

Matt white
Blanco mate

Matt black
Negro mate

←→ | o — o
174 mm 128 mm

⊕
Technical info on page 265
Info técnica en pág 265



0543

SOFT

ZAMAK

Designer: Uli Budde



Finishes
Acabados

	←→	o — o
Matt white <i>Blanco mate</i>	40 mm	32 mm
Matt black <i>Negro mate</i>	200 mm	192 mm
Moss grey <i>Gris musgo</i>	328 mm	320 mm

⊕
Technical info on page 264
Info técnica en pág 264



0552

RIM

ZAMAK

Designer: Bernat Lluch

Finishes
Acabados

Brushed nickel
Níquel cepillado

NEW! Brushed brass cava
Latón cava cepillado

Matt white
Blanco mate

Matt black
Negro mate

Moss grey
Gris musgo

←→ | o — o
120 mm 96 mm



⊕
Technical info on page 264
Info técnica en pág 264



0553

OTO

ZAMAK

Designer: Bernat Lluch



Finishes
Acabados

Black textured
Negro texturizado

←→	○ — ○
60 mm	-
168 mm	128 mm

⊕
Technical info on page 265
Info técnica en pág 265



0556

DIPO

ZAMAK

Designer: Bernat Llorch



Finishes
Acabados

Matt white
Blanco mate

Matt black
Negro mate

Moss grey
Gris musgo



74 mm



Technical info on page 263
Info técnica en pág 263



0372

ONA

ALUMINIUM

Designer: Teruel & Paré

Finishes
Acabados

Stainless steel look
Inox look

Brushed dark brass
Latón cepillado oscuro

Brushed black
Negro cepillado

Brushed grey
Gris cepillado

Matt white
Blanco mate

Metallic grey
Gris metal

Metallic brown
Marrón metal



←→	○ — ○ 1	○ — ○ 2
50 mm	32 mm	-
200 mm	128 mm	-
350 mm	256 mm	-
600 mm	544 mm	-
1100 mm	1056 mm	416 mm
1500 mm	1440 mm	480 mm



Technical info on page 286
Info técnica en pág 286



0372

ONA

ALUMINIUM

Designer: Teruel & Paré

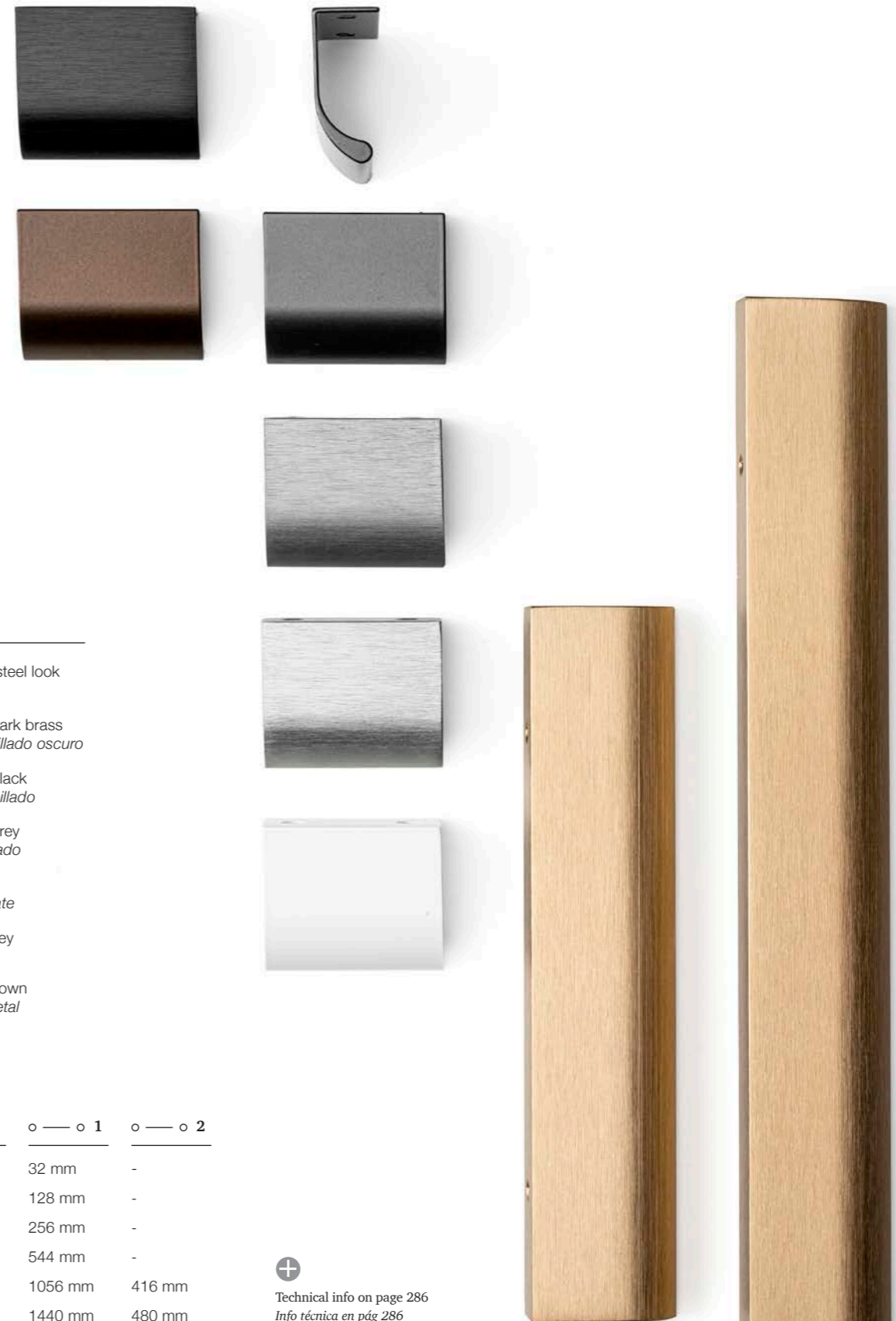

Finishes
Acabados

- Stainless steel look
Inox look
- Brushed dark brass
Latón cepillado oscuro
- Brushed black
Negro cepillado
- Brushed grey
Gris cepillado
- Matt white
Blanco mate
- Metallic grey
Gris metal
- Metallic brown
Marrón metal

←→	○ — ○ 1	○ — ○ 2
50 mm	32 mm	-
200 mm	128 mm	-
350 mm	256 mm	-
600 mm	544 mm	-
1100 mm	1056 mm	416 mm
1500 mm	1440 mm	480 mm

⊕
Technical info on page 286
Info técnica en pág 286

0254 / 0255

NOMA

ALUMINIUM

Designer: 2J Design



Finishes
Acabados

Anodized bright
Anodizado brillo

Stainless steel look
Inox look

Brushed black
Negro cepillado

Antique bronze
Bronce antiguo

Brushed brass cava
Latón cava cepillado

←→	o — o
200 mm	128 mm
350 mm	256 mm

⊕
Technical info on page 288
Info técnica en pág 288

0077

ANGLE

ALUMINIUM

Designer: Viefe Studio



Finishes Acabados

Polished chrome
Cromo brillo

Anodized matt
Anodizado mate

Stainless steel look
Inox look

Brushed dark brass
Latón oscuro cepillado

Matt White
Bianco mate

Matt black
Negro mate

Metallic grey
Gris metal

Metallic brown
Marrón metal

←→ | o — o

- 45 mm
- 90 mm
- 100 mm
- 120 mm
- 150 mm
- 190 mm
- 200 mm
- 250 mm
- 300 mm
- 400 mm
- 500 mm
- 600 mm
- 900 mm
- 1480 mm

⊕
 Technical info on page 283
Info técnica en pág 283

0077

ANGLE

ALUMINIUM

Designer: Viefe Studio





0495

FLOID

ZAMAK

Designer: Frank Person



Finishes
Acabados

Brushed gold
Oro cepillado

Pewter
Peltre

Antique brass
Latón antiguo

Matt black
Negro mate

←→	o — o
Ø34,8 mm	-
143,6 mm	128 mm
207,6 mm	192 mm

⊕
Technical info on page 268
Info técnica en pág 268



0496

BAU

ZAMAK

Designer: Patricia Roig



Finishes
Acabados

Brushed nickel
Níquel cepillado

Brushed gold
Oro cepillado

Matt black
Negro mate

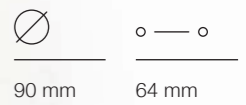

⊕
Technical info on page 268
Info técnica en pág 268

0127

JEY

ALUMINIUM

Designer: Viefe Studio



Finishes
Acabados

Stainless steel look
Inox look

Brushed brass cava
Latón cava cepillado

Matt white
Blanco mate

Matt black
Negro mate

←→|

147 mm
197 mm
247 mm
297 mm
347 mm
397 mm
447 mm
497 mm
597 mm
697 mm
797 mm
897 mm
997 mm
1197 mm
3000 mm*

* Available only in M1 and M2 finishes. Three metre profiles are delivered according to the units of the original packaging and cannot be sold separately.

Disponibile solo en los acabados M1 y M2. Las barras de tres metros se sirven según las cantidades del embalaje original y no se pueden servir por separado.

⊕
Technical info on page 269
Info técnica en pág 269



0127 **JEY**

0163 **JEY2** (above)

ALUMINIUM

Designer: Viefe Studio

Finishes
Acabados

Stainless steel look
Inox look

Brushed brass cava
Latón cava cepillado

Matt white
Blanco mate

Matt black
Negro mate

←→|

147 mm
197 mm
247 mm
297 mm
347 mm
397 mm
447 mm
497 mm
597 mm
697 mm
797 mm
897 mm
997 mm
1197 mm
3000 mm*

* Available only in M1 and M2 finishes. Three metre profiles are delivered according to the units of the original packaging and cannot be sold separately.

Disponibile solo en los acabados M1 y M2. Las barras de tres metros se sirven según las cantidades del embalaje original y no se pueden servir por separado.



Technical info on page 269
Info técnica en pág 269



0487

PURA

ZAMAK

Designer: Balutto Associati



Finishes
Acabados

Polished chrome
Cromo brillo

Polished black nickel
Níquel negro brillo

Polished copper
Cobre brillo

Polished brass
Latón brillo

←→

168 mm

o — o

160 mm



Technical info on page 268
Info técnica en pág 268



0168

COMO

ZAMAK

Designer: Viefe Studio



Finishes
Acabados

Polished chrome
Cromo brillo

Polished black nickel
Niquel negro brillo

Polished copper
Cobre brillo

Polished brass
Latón brillo



26 mm
41 mm



Technical info on page 270
Info técnica en pág 270



0168

COMO

ZAMAK

Designer: Viefe Studio

Finishes
Acabados

Matt chrome
Cromo mate

Brushed nickel
Níquel cepillado

Brushed copper
Cobre cepillado

Brushed gold
Oro cepillado

Matt black
Negro mate

Matt white
Blanco mate



26 mm

41 mm



Technical info on page 270
Info técnica en pág 270



0497

DIABOLO

ALUMINIUM

Designer: Frank Person



Finishes Acabados

Stainless steel look
Inox look

Brushed brass
Latón cepillado

Brushed black
Negro cepillado

Brushed grey
Gris cepillado



13,5 mm



Technical info on page 270
Info técnica en pág 270



0499

ROUND

ALUMINIUM

Designer: Balutto Associati



Finishes
Acabados

Stainless steel look
Inox look

Brushed brass
Latón cepillado

Brushed black
Negro cepillado



25 mm



Technical info on page 270
Info técnica en pág 270



0518

WAY

ALUMINIUM

Designer: Viefe Studio



Finishes
Acabados

	←→	○ — ○ 1	○ — ○ 1/2	○ — ○ 2
Anodized matt <i>Anodizado mate</i>	50 mm	32 mm	-	-
	100 mm	64 mm	-	-
Stainless steel look <i>Inox look</i>	200 mm	128 mm	-	-
	400 mm	320 mm	-	-
Brushed dark brass <i>Latón oscuro cepillado</i>	800 mm	736 mm	368 mm	-
Matt White <i>Blanco mate</i>	1100 mm	1056 mm	-	352 mm
Matt black <i>Negro mate</i>				

⊕
Technical info on page 271
Info técnica en pág 271

0518

WAY

ALUMINIUM

Designer: Viefe Studio

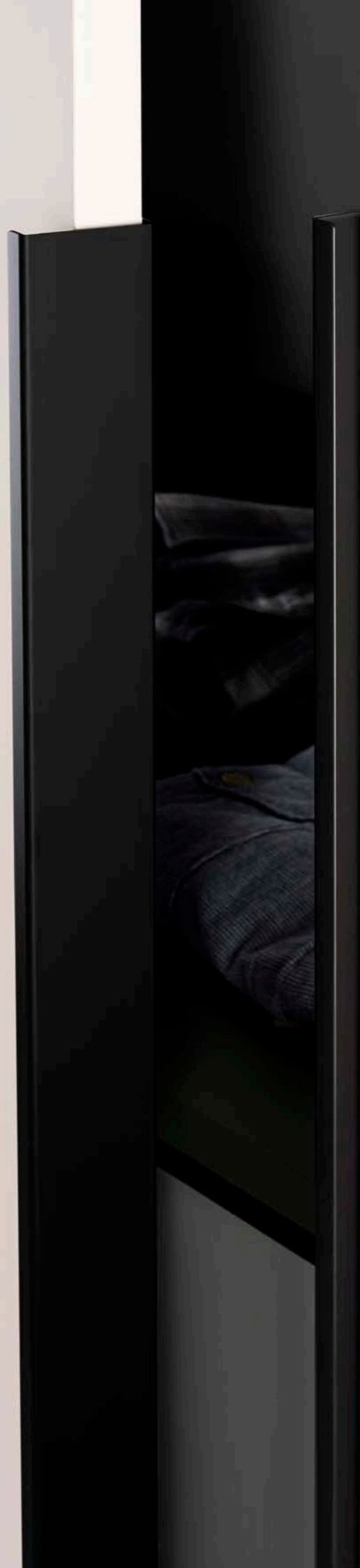

Finishes
Acabados

Anodized matt
Anodizado mate

Stainless steel look
Inox look

Brushed dark brass
Latón oscuro cepillado

Matt White
Blanco mate

Matt black
Negro mate

←→	o — o 1	o — o 1/2	o — o 2
50 mm	32 mm	-	-
100 mm	64 mm	-	-
200 mm	128 mm	-	-
400 mm	320 mm	-	-
800 mm	736 mm	368 mm	-
1100 mm	1056 mm	-	352 mm

⊕
Technical info on page 271
Info técnica en pág 271



0511

RAIL

ALUMINIUM

Designer: Teruel & Paré



Finishes
Acabados

Stainless steel look
Inox look

Brushed black
Negro cepillado

Brushed brass cava
Latón cava cepillado

←→	o — o 1	o — o 2
180 mm	160 mm	-
280 mm	192 mm	-
600 mm	576 mm	192 mm
* 1150 mm	1120 mm	192 mm

* Off-center / *Descentrado*

⊕
Technical info on page 272
Info técnica en pág 272



0511

RAIL

ALUMINIUM

Designer: Teruel & Paré



Finishes
Acabados

Stainless steel look
Inox look

Brushed black
Negro cepillado

Brushed brass cava
Latón cava cepillado

←→	o — o 1	o — o 2
180 mm	160 mm	-
280 mm	192 mm	-
600 mm	576 mm	192 mm
* 1150 mm	1120 mm	192 mm

* Off-center / *Descentrado*



Technical info on page 272
Info técnica en pág 272



0056

U

ZAMAK

Designer: Viefe Studio

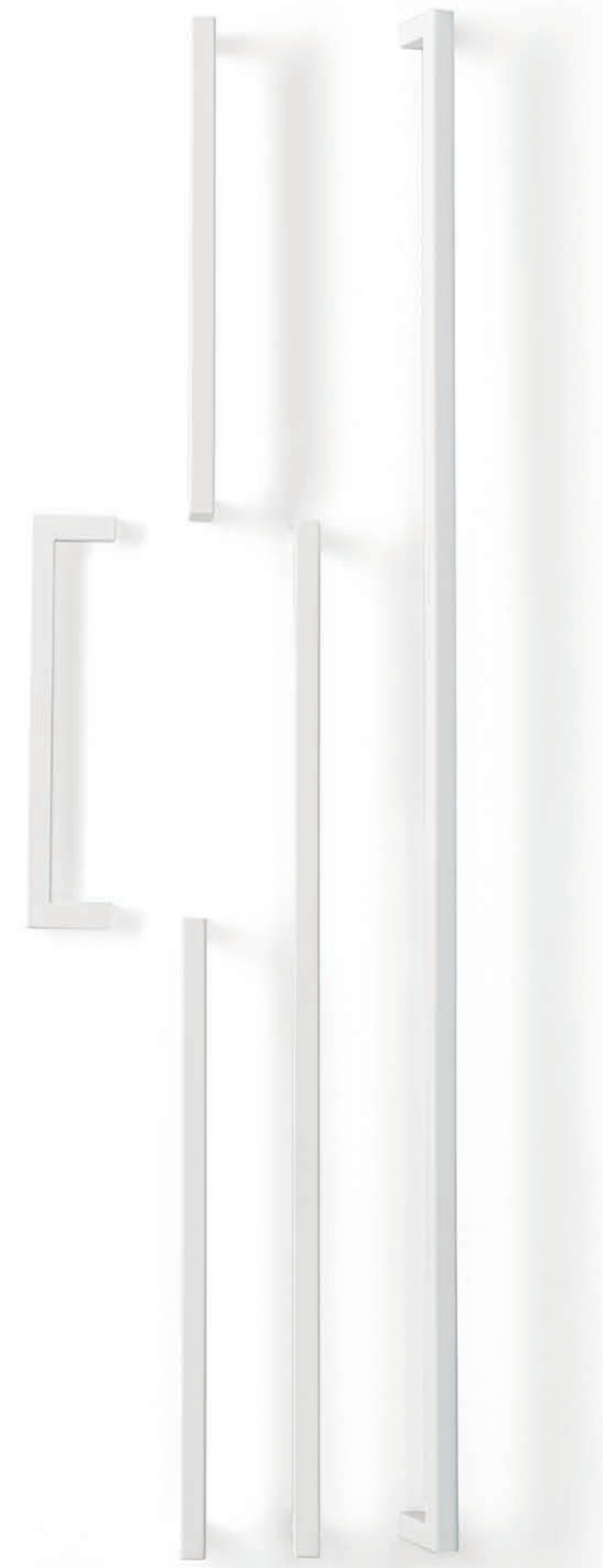

Finishes
Acabados

Matt white
Blanco mate

←→	o — o
136,5 mm	128 mm
168,5 mm	160 mm
200,5 mm	192 mm
328,5 mm	320 mm
500,5 mm	492 mm

⊕
Technical info on page 272
Info técnica en pág 272



0056

U

ZAMAK

Designer: Viefe Studio

Finishes
Acabados

	←→	o — o
Polished chrome <i>Cromo brillo</i>	136,5 mm	128 mm
Matt chrome <i>Cromo mate</i>	168,5 mm	160 mm
Matt nickel <i>Niquel cepillado</i>	200,5 mm	192 mm
Brushed nickel <i>Niquel cepillado</i>	328,5 mm	320 mm
Matt black <i>Negro mate</i>		
Brushed copper <i>Cobre cepillado</i>		
Brushed brass <i>Latón cepillado</i>		
Matt white <i>Blanco mate</i>		
Brushed grey <i>Gris cepillado</i>		



⊕
Technical info on page 272
Info técnica en pág 272



0241

ROMA

ZAMAK

Designer: 2J Design



Finishes
Acabados

Polished chrome
Cromo brillo

Brushed nickel
Níquel cepillado

Brushed gold
Oro cepillado

Matt black
Negro mate

← →	o — o
175 mm	160 mm
207 mm	192 mm
335 mm	320 mm

⊕
Technical info on page 273
Info técnica en pág 273



0241

ROMA

ZAMAK

Designer: 2J Design



Finishes
Acabados

Polished chrome
Cromo brillo

Brushed nickel
Níquel cepillado

Brushed gold
Oro cepillado

Matt black
Negro mate

←→ | o — o

175 mm 160 mm

207 mm 192 mm

335 mm 320 mm



Technical info on page 273
Info técnica en pág 273



0489

BOL

ZAMAK / WOOD

Designer: Balutto Associati

Finishes Acabados

Matt black + Sapelly
Negro mate + Sapelly

Matt black + Beech
Negro mate + Haya

Matt black + Matt white lacquered
Negro mate + Lacado blanco mate



45 mm



Technical info on page 271
Info técnica en pág 271



0507

OBLONG

LEATHER / ZAMAK

Designer: Frank Person

Finishes Acabados

Polished chrome + Beige / Brown / Black
Cromo brillo + Beige / Marrón / Negro

Brushed gold + Beige / Brown / Black
Oro cepillado + Beige / Marrón / Negro

Brushed grey + Beige / Brown / Black
Gris cepillado + Beige / Marrón / Negro

Matt white + Beige
Blanco mate + Beige

Matt black + Beige / Brown / Black
Negro mate + Beige / Marrón / Negro

←→	o — o
70 mm	-
197 mm	160 mm



⊕
Technical info on page 273
Info técnica en pág 273

0494

LAND

ZAMAK

Designer: Héctor Diego



Finishes
Acabados

Brushed gold
Oro cepillado

Pewter
Peltre

Antique brass
Latón antiguo

Matt black
Negro mate

←→	o — o
40 (Ø) mm	-
98 mm	64 mm

⊕
Technical info on page 274
Info técnica en pág 274



0516

PENDANT

ZAMAK

Designer: Frank Person



Finishes
Acabados

Pewter
Peltre

Antique brass
Latón antiguo

Matt black
Negro mate

←→	o — o
39,3 mm	-
138,4 mm	128 mm

⊕
Technical info on page 276
Info técnica en pág 276



0516

PENDANT

ZAMAK

Designer: Frank Person



Finishes
Acabados

Pewter
Peltre

←→
39,3 mm
138,4 mm

○ — ○
-
128 mm

Antique brass
Latón antiguo

Matt black
Negro mate



Technical info on page 276
Info técnica en pág 276



0486

GRAF BIG

ALUMINIUM

Designer: Viefe Studio

Finishes
Acabados

Stainless steel look
Inox look

Brushed brass
Latón cepillado

Brushed black
Negro cepillado

	←→	o — o 1	o — o 2
Stainless steel look <i>Inox look</i>	(Ø) 38 mm	-	-
	(Ø) 50 mm	-	-
Brushed brass <i>Latón cepillado</i>	224 mm	192 mm	-
	352 mm	320 mm	-
Brushed black <i>Negro cepillado</i>	1200 mm	1168 mm	584 mm



Technical info on page 277
Info técnica en pág 277



0486

GRAF BIG

ALUMINIUM

Designer: Viefe Studio



Finishes
Acabados

Stainless steel look
Inox look

Brushed brass
Latón cepillado

Brushed black
Negro cepillado



←→	o — o 1	o — o 2
(Ø) 38 mm	-	-
(Ø) 50 mm	-	-
224 mm	192 mm	-
352 mm	320 mm	-
1200 mm	1168 mm	584 mm



Technical info on page 277
Info técnica en pág 277

0486

GRAF BIG

ALUMINIUM

Designer: Viefe Studio



Finishes
Acabados

Stainless steel look
Inox look

Brushed brass
Latón cepillado

Brushed black
Negro cepillado

←→	o — o 1	o — o 2
(Ø) 38 mm	-	-
(Ø) 50 mm	-	-
224 mm	192 mm	-
352 mm	320 mm	-
1200 mm	1168 mm	584 mm

⊕
Technical info on page 277
Info técnica en pág 277



0430

GRAF MINI

ALUMINIUM

Designer: Viefe Studio

Finishes
Acabados

	←→	○ — ○ 1	○ — ○ 2
Stainless steel look <i>Inox look</i>	10 mm	-	-
Brushed brass <i>Latón cepillado</i>	182 mm	160 mm	-
Brushed black <i>Negro cepillado</i>	278 mm	256 mm	-
	1200 mm	1178 mm	589 mm

Includes non-twisting tip / Incluye punta anti-giro



Technical info on page 277
Info técnica en pág 277

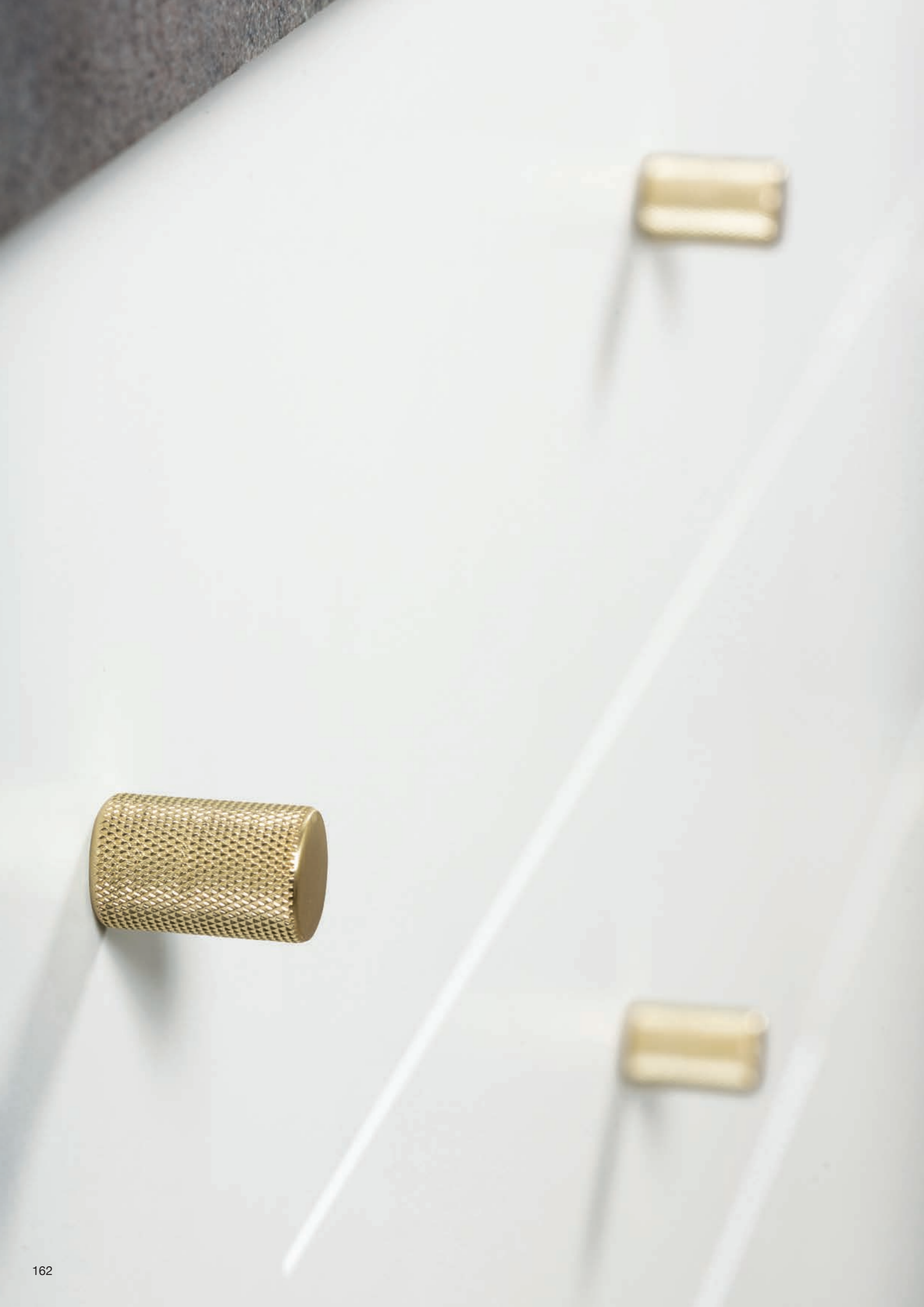

0109

GRAF

ALUMINIUM

Designer: Viefe Studio

Finishes
Acabados

Polished chrome
Cromo brillo

Anodized matt
Anodizado mate

Stainless steel look
Inox look

Brushed brass
Latón cepillado

Matt black
Negro mate

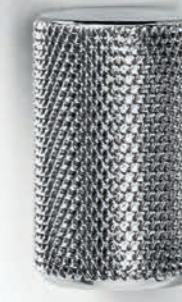

17,5 mm



Technical info on page 278
Info técnica en pág 278



0459

LINES

ZAMAK

Designer: Teruel & Paré

Finishes Acabados

Brushed Níquel
Níquel cepillado

Brushed gold
Oro cepillado

Brushed mole grey
Gris topo cepillado

Matt black
Negro mate

← →

170 mm

330 mm

o — o

160 mm

320 mm



Technical info on page 275
Info técnica en pág 275

0446

ESTE

ZAMAK

Designer: Balutto Associati



Finishes
Acabados

Polished chrome
Cromo brillo

Matt chrome
Cromo mate

Brushed nickel
Níquel cepillado

Brushed copper
Cobre cepillado

Brushed gold
Oro cepillado

Graphite grey
Gris grafito

Matt black
Negro mate

←→ | o — o
172 mm 160 mm



Technical info on page 274
Info técnica en pág 274



0447

BELLA

ZAMAK

Designer: Balutto Associati

Finishes
Acabados

Brushed copper
Cobre cepillado

Brushed gold
Oro cepillado

Graphite grey
Gris grafito

Matt black
Negro mate

←→ | o — o
176 mm 160 mm

⊕
Technical info on page 278
Info técnica en pág 278

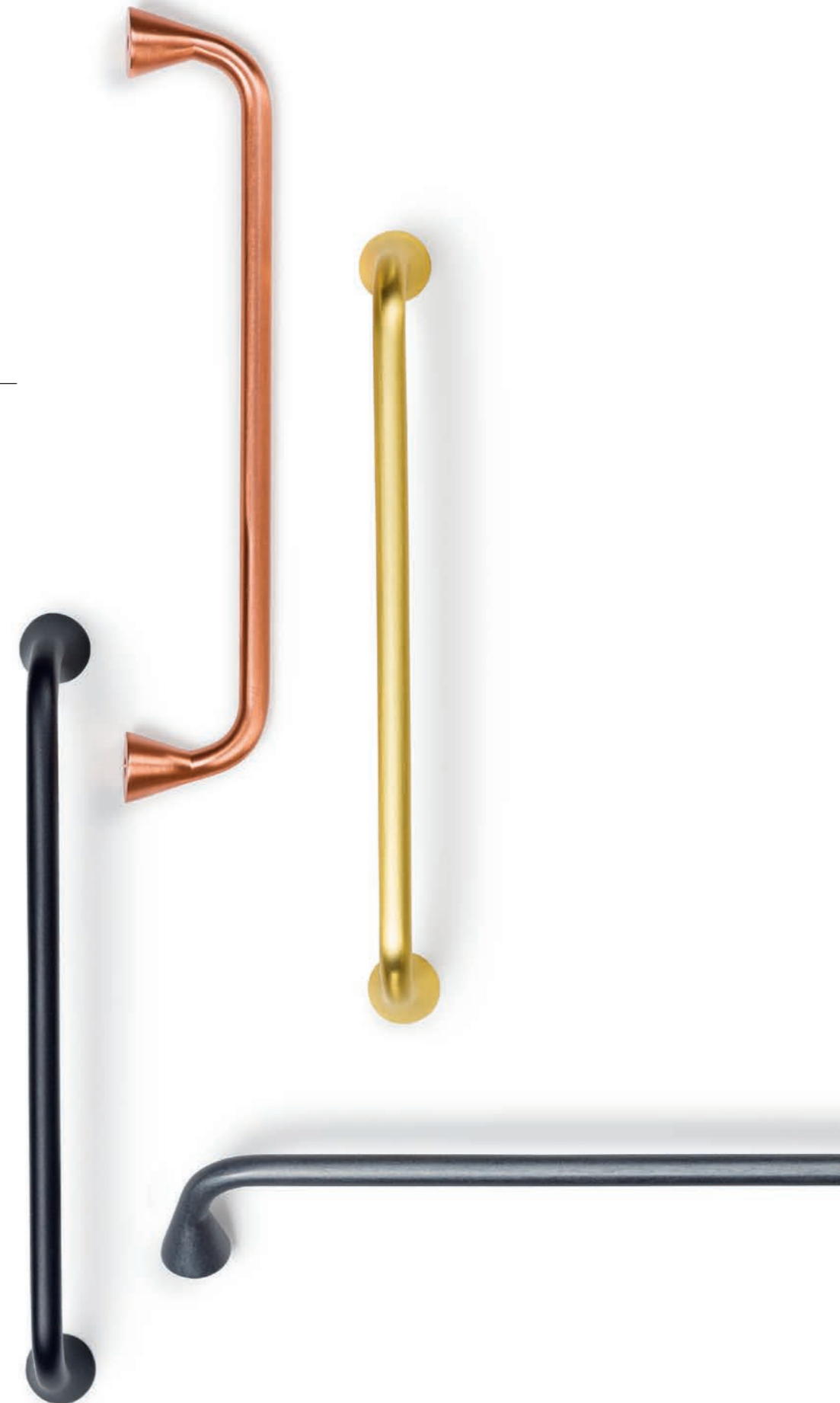



0449

HEXXA

ALUMINIUM + ZAMAK

Designer: Alexis Vivet

Finishes
Acabados

Matt white
Blanco mate

Matt black
Negro mate

Metallic grey
Gris metal

Metallic brown
Marrón metal



200 mm
350 mm
1100 mm
3000 mm *

* Three metre profiles are delivered according to the units of the original packaging and cannot be sold separately.
Las barras de tres metros se sirven según las cantidades del embalaje original y no se pueden servir por separado.



Technical info on page 279
Info técnica en pág 279

0449

HEXXA

ALUMINIUM + ZAMAK

Designer: Alexis Vivet

Finishes Acabados

Matt white
Blanco mate

Matt black
Negro mate

Metallic grey
Gris metal

Metallic brown
Marrón metal

|←→|

200 mm

350 mm

1100 mm

3000 mm *

*
Three metre profiles are delivered according to the units of the original packaging and cannot be sold separately.

Las barras de tres metros se sirven según las cantidades del embalaje original y no se pueden servir por separado.



Technical info on page 279
Info técnica en pág 279





0094

HIDE

ZAMAK

Designer: Viefe Studio



Finishes
Acabados

	←→	o — o
Polished chrome <i>Cromo brillo</i>	90 mm 180 mm	64 mm 128 mm
Brushed nickel <i>Níquel cepillado</i>	200 mm	128 mm
Brushed gold <i>Oro cepillado</i>		
Matt white <i>Blanco mate</i>		
Matt black <i>Negro mate</i>		
Chrome look <i>Cromo look</i>		

⊕
Technical info on page 276
Info técnica en pág 276



0119

WAVE

ZAMAK

Designer: Viefe Studio



**Finishes
Acabados**

Polished chrome
Cromo brillo
Brushed nickel
Níquel cepillado
Matt black
Negro mate



45 mm
173 mm



32 mm
160 mm



Technical info on page 279
Info técnica en pág 279



0105

(combinable with 0094)

NEST

ZAMAK

Designer: Viefe Studio



Finishes
Acabados

Polished chrome
Cromo brillo

Brushed nickel
Níquel cepillado

Polished chrome + White
Cromo brillo + Blanco

Brushed nickel + White
Níquel cepillado + Blanco

Matt black
Negro mate

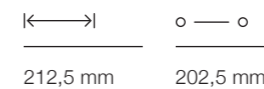

⊕
Technical info on page 280
Info técnica en pág 280



0235

CLOS

ZAMAK

Designer: Viefe Studio



Finishes

Acabados

Matt white
Blanco mate

Matt black
Negro mate

Polished chrome
Cromo brillo

Brushed nickel
Níquel cepillado



160 mm



128 mm



Technical info on page 280
Info técnica en pág 280

0366

CUBIC

ZAMAK

Designer: Viefe Studio



Finishes
Acabados

Matt white
Blanco mate

Matt black
Negro mate

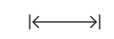

160 mm



Technical info on page 280
Info técnica en pág 280

0073

TAP

ZAMAK

Designer: Viefe Studio



Finishes
Acabados

Chrome look
Cromo look

Matt black
Negro mate

∅ 1

35,5 mm

55,3 mm

∅ 2

40 mm

60 mm



Technical info on page 281
Info técnica en pág 281



0301

SENSE MINI

ALUMINIUM

Designer: Viefe Studio



Finishes
Acabados

Polished chrome
Cromo brillo

Matt black
Negro mate

Stainless steel look
Inox look

Brushed dark brass
Latón oscuro cepillado

←→	o — o
103 mm	96 mm
167 mm	160 mm
263 mm	256 mm

⊕
Technical info on page 281
Info técnica en pág 281



0195

SENSE

ALUMINIUM

Designer: Viefe Studio



Finishes Acabados

Polished chrome
Cromo brillo

Stainless steel look
Inox look

Brushed black
Negro cepillado

←→	○ — ○
135 mm	128 mm
199 mm	192 mm
327 mm	320 mm
487 mm	480 mm

⊕
Technical info on page 281
Info técnica en pág 281



0451

FELTRE

ZAMAK

Designer: Balutto Associati

Finishes
Acabados

Brushed nickel
Níquel cepillado

Graphite grey
Gris grafito

Matt black
Negro mate

←→ | o — o
218 mm 192 mm

⊕
Technical info on page 278
Info técnica en pág 278



0452

BRAVE

ALUMINIUM

Designer: Viefe Studio



Finishes
Acabados

Matt white
Blanco mate

Matt black
Negro mate

Metallic grey
Gris metal

Metallic brown
Marrón metal

↳—→	○ — ○ 1	○ — ○ 2
160 mm	128 mm	-
240 mm	192 mm	-
400 mm	320 mm	-
600 mm	192 mm	480 mm
1040 mm	192 mm	992 mm
1150 mm	192 mm	1120 mm



Technical info on page 284
Info técnica en pág 284

0444

PEAK

ALUMINIUM

Designer: Viefe Studio



Finishes
Acabados

Stainless steel look
Inox look

Brushed black
Negro cepillado

Matt white
Blanco mate

Metallic grey
Gris metal

Metallic brown
Marrón metal

←→	o — o 1	o — o 2
120 mm	64 mm	-
250 mm	192 mm	160 mm
500 mm	448 mm	160 mm
800 mm	768 mm	160 mm
1150 mm	1120 mm	160 mm
1800 mm	1760 mm	160 mm

⊕
Technical info on page 285
info técnica en pág 285



0341

ASI

ALUMINIUM

Designer: Oriol Barri



Finishes
Acabados

Matt black
Negro mate

←→	o — o
146 mm	128 mm
210 mm	192 mm
338 mm	320 mm

⊕
Technical info on page 282
Info técnica en pág 282



0375

VANN

ALUMINIUM

Designer: Alexis Vivet



Finishes
Acabados

Anodized bright
Anodizado brillo

Anodized matt
Anodizado mate

Matt black
Negro mate

Stainless steel look
Inox look

Brushed dark brass
Latón oscuro cepillado

	◀—▶	○ — ○ 1	○ — ○ 2
Anodized bright	100 mm	64 mm	-
Anodized matt	200 mm	128 mm	-
Matt black	350 mm	256 mm	-
Stainless steel look	1200 mm	1120 mm	384mm

⊕
Technical info on page 285
Info técnica en pág 285



Finishes Acabados

Anodized bright
Anodizado brillo

Anodized matt
Anodizado mate

Matt black
Negro mate

Stainless steel look
Inox look

Brushed dark brass
Latón oscuro cepillado

←→	○ — ○ 1	○ — ○ 2
100 mm	64 mm	-
200 mm	128 mm	-
350 mm	256 mm	-
1200 mm	1120 mm	384mm



Technical info on page 285
Info técnica en pág 285

0117

CURVE

ALUMINIUM

Designer: Viefe Studio

Finishes

Acabados

Anodized matt
Anodizado mate

Stainless steel look
Inox look

Brushed grey
Gris cepillado

Matt white
Blanco mate

Matt black
Negro mate

←→

o — o

45 mm

32 mm

100 mm

64 mm

200 mm

128 mm

300 mm

192 mm

400 mm

320 mm

500 mm

416 mm



Technical info on page 287
Info técnica en pág 287

0139 / 0140

LINEAR

ALUMINIUM

Designer: Viefe Studio



Finishes
Acabados

Stainless steel look
Inox look

Brushed black
Negro cepillado

←→

- 147 mm
- 197 mm
- 247 mm
- 297 mm
- 347 mm
- 397 mm
- 447 mm
- 497 mm
- 597 mm
- 697 mm
- 797 mm
- 897 mm
- 997 mm
- 1197 mm



⊕
Technical info on page 287
Info técnica en pág 287

0434 / 0435 / 0436

VECTOR

ALUMINIUM

Designer: Viefe Studio



Finishes Acabados

Stainless steel look
Inox look

Brushed black
Negro cepillado

Brushed grey
Gris cepillado

←→

147 mm

197 mm

247 mm

297 mm

347 mm

397 mm

447 mm

497 mm

597 mm

697 mm

797 mm

897 mm

997 mm

1197 mm

⊕
Technical info on page 288
Info técnica en pág 288



0343

GRADA

ALUMINIUM

Designer: Viefe Studio

Finishes Acabados

|←→|

Anodized matt <i>Anodizado mate</i>	147 mm
	197 mm
Stainless steel look <i>Inox look</i>	247 mm
	297 mm
Matt white <i>Blanco mate</i>	347 mm
	397 mm
Matt black <i>Negro mate</i>	447 mm
	497 mm
Anodized bright <i>Anodizado brillo</i>	597 mm
	697 mm
	797 mm
	897 mm
	997 mm
	1197 mm
	3000 mm *

*
Three metre profiles are delivered according to the units of the original packaging and cannot be sold separately.

Las barras de tres metros se sirven según las cantidades del embalaje original y no se pueden servir por separado.



Technical info on page 290
Info técnica en pág 290

0380

STEEP

ALUMINIUM

Designer: Viefe Studio

Finishes
Acabados

Anodized bright
Anodizado brillo

Stainless steel look
Inox look

Matt black
Negro mate



3000 mm

Three metre profiles are delivered according to the units of the original packaging and cannot be sold separately.

Las barras de tres metros se sirven según las cantidades del embalaje original y no se pueden servir por separado.



Technical info on page 290
Info técnica en pág 290

0250 / 0251 / 0253

FORMA

ALUMINIUM

Designer: 2J Design



147 mm

197 mm

247 mm

297 mm

347 mm

397 mm

Finishes
Acabados

Stainless steel look
Inox look

447 mm

497 mm

597 mm

697 mm

797 mm

897 mm

997 mm

1197 mm



Technical info on page 289
Info técnica en pág 289

0334

BRIKK

ALUMINIUM

Designer: Alexis Vivet

Finishes
Acabados

	←→	○ — ○ 1	○ — ○ 2	○ — ○ 3
140 mm		32 mm	-	-
190 mm		64 mm	-	-
240 mm		96 mm	-	-
290 mm		160 mm	-	-
340 mm		192 mm	-	-
390 mm		128 mm	260 mm	-
440 mm		160 mm	310 mm	-
490 mm		192 mm	360 mm	-
590 mm		224 mm	460 mm	-
690 mm		256 mm	560 mm	-
790 mm		320 mm	660 mm	-
890 mm		384 mm	760 mm	-
990 mm		320 mm	640 mm	860 mm
1190 mm		320 mm	832 mm	1060 mm



Technical info on page 289
Info técnica en pág 289



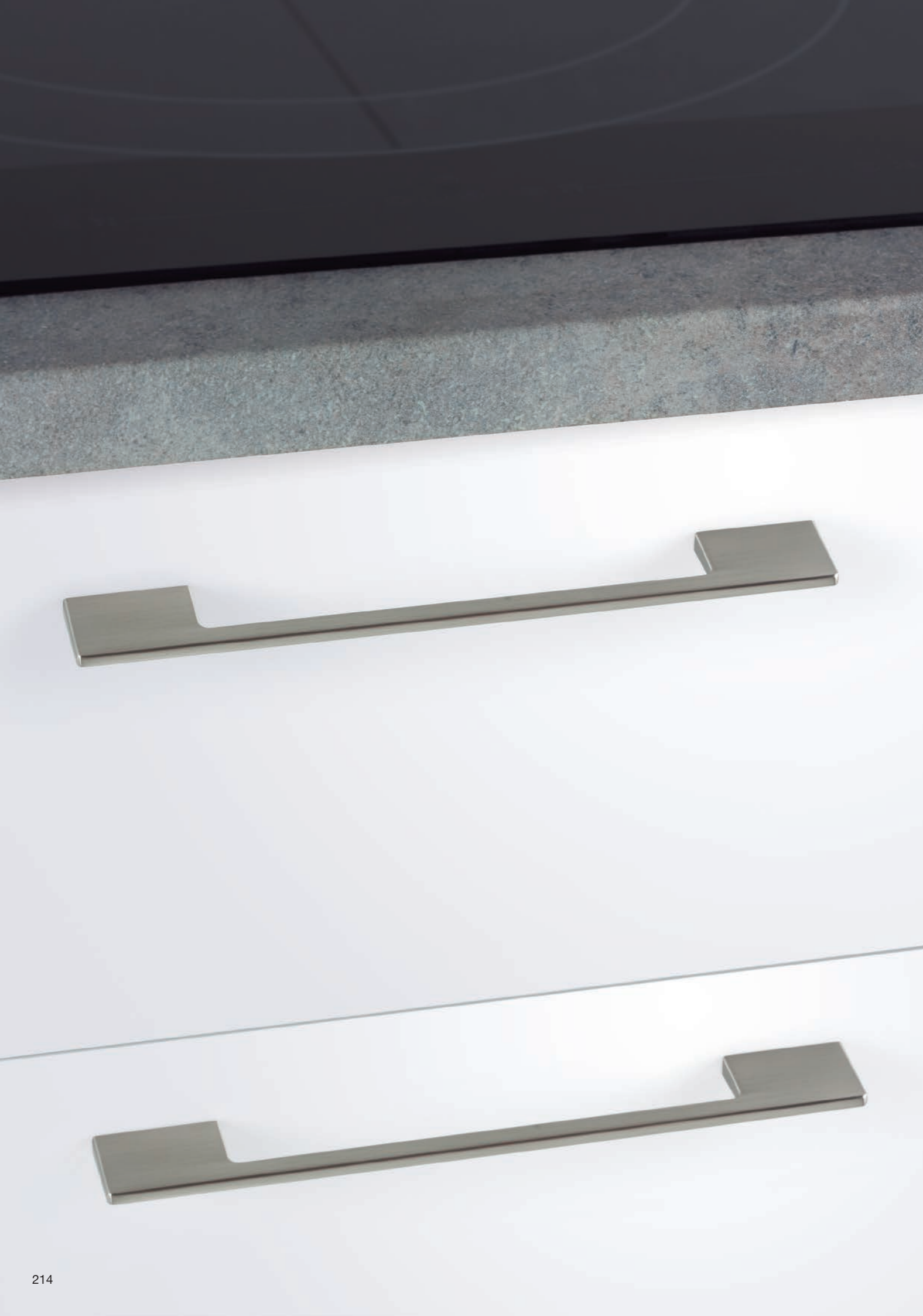

0053

DINO

ZAMAK

Designer: Viefe Studio



Finishes
Acabados

Polished chrome
Cromo brillo

Brushed nickel
Niquel cepillado

Matt white
Blanco mate

Matt black
Negro mate

Aluminium look
Aluminio look

←→	o — o 1	o — o 2
156 mm	96 mm	128 mm
221 mm	160 mm	192 mm
349 mm	288 mm	320 mm

⊕
Technical info on page 286
Info técnica en pág 286



0373

NICK

ZAMAK

Designer: Alexis Vivet



Finishes
Acabados

Polished chrome
Cromo brillo

Brushed nickel
Níquel cepillado

Brushed copper
Cobre cepillado

Brushed brass
Latón cepillado

←→	o — o
50 mm	32 mm
178 mm	160 mm

⊕
Technical info on page 282
Info técnica en pág 282

0322

CUTT

ALUMINIUM

Designer: Alexis Vivet

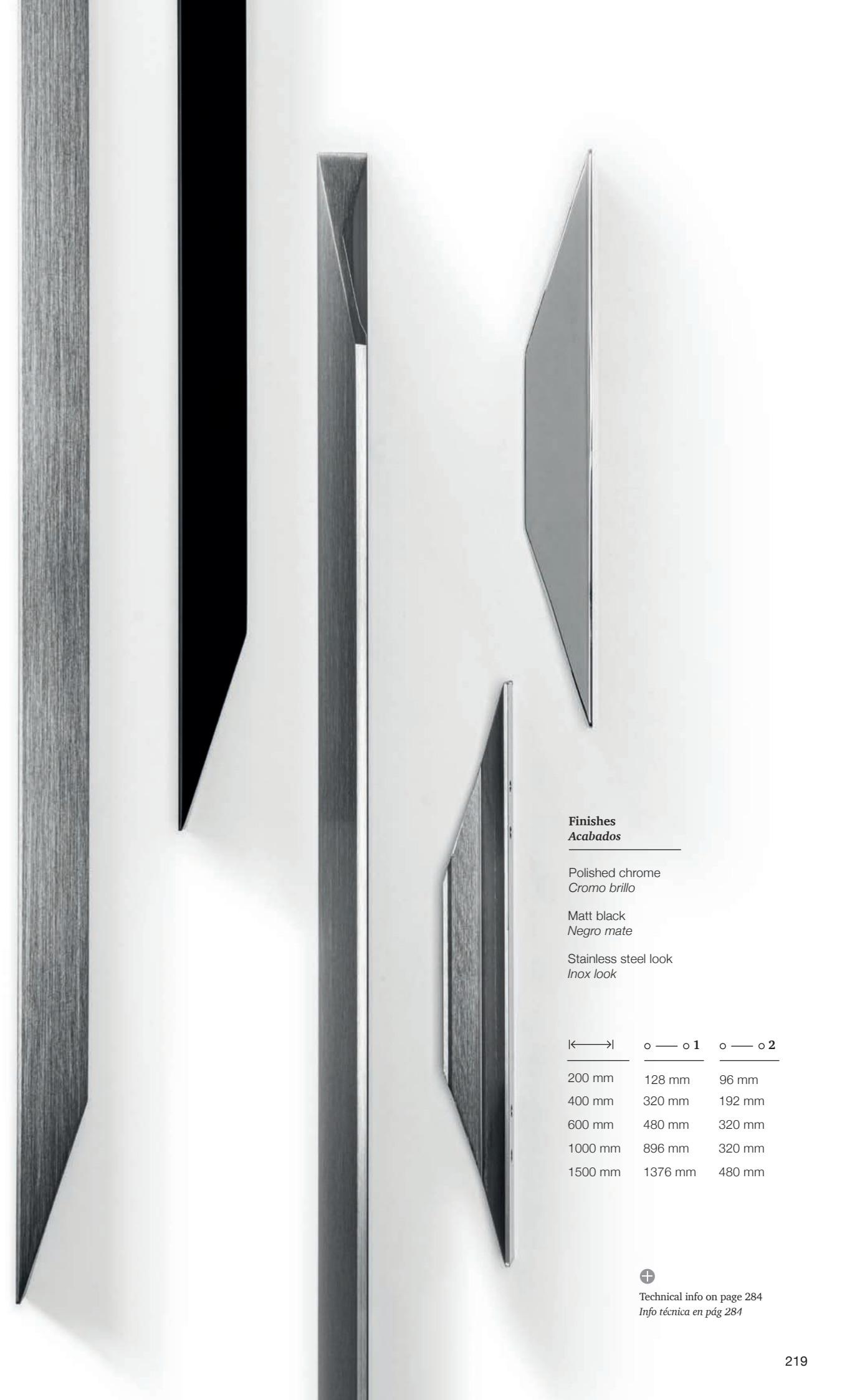

Finishes
Acabados

Polished chrome
Cromo brillo

Matt black
Negro mate

Stainless steel look
Inox look

$\overline{\text{K}} \rightarrow \text{I}$	$\circ \text{---} \circ 1$	$\circ \text{---} \circ 2$
200 mm	128 mm	96 mm
400 mm	320 mm	192 mm
600 mm	480 mm	320 mm
1000 mm	896 mm	320 mm
1500 mm	1376 mm	480 mm



Technical info on page 284
Info técnica en pág 284

0108

TWISTED

ZAMAK

Designer: Viefe Studio



Finishes
Acabados

Polished chrome
Cromo brillo

Brushed nickel
Níquel cepillado



170 mm
234 mm
340 mm



160 mm
224 mm
320 mm



Technical info on page 291
Info técnica en pág 291



0239

ARA

ALUMINIUM

Designer: 2J Design



Finishes
Acabados

Stainless steel look
Inox look



156 mm
252 mm
380 mm



96 mm
192 mm
320 mm



Technical info on page 291
Info técnica en pág 291



0410

BUTTON

ZAMAK

Designer: Alexis Vivet



Finishes

Acabados

Polished chrome
Cromo brillo

Pewter
Peltre

Antique Brass
Latón antiguo

Matt black
Negro mate



175 mm



160 mm



Technical info on page 292
Info técnica en pág 292



0393

DUKE

ZAMAK

Designer: Viefe Studio



Finishes
Acabados

Antique copper
Cobre antiguo

Antique silver
Plata antigua

Matt black
Negro mate

Matt white
Blanco mate

Pewter
Peltre

Antique Brass
Latón antiguo

Polished chrome
Cromo brillo

Brushed nickel
Níquel cepillado

Brushed brass
Latón cepillado

Brushed copper
Cobre cepillado



31,4 mm



Technical info on page 292
Info técnica en pág 292

0226

REDO

ZAMAK

Designer: 2J Design

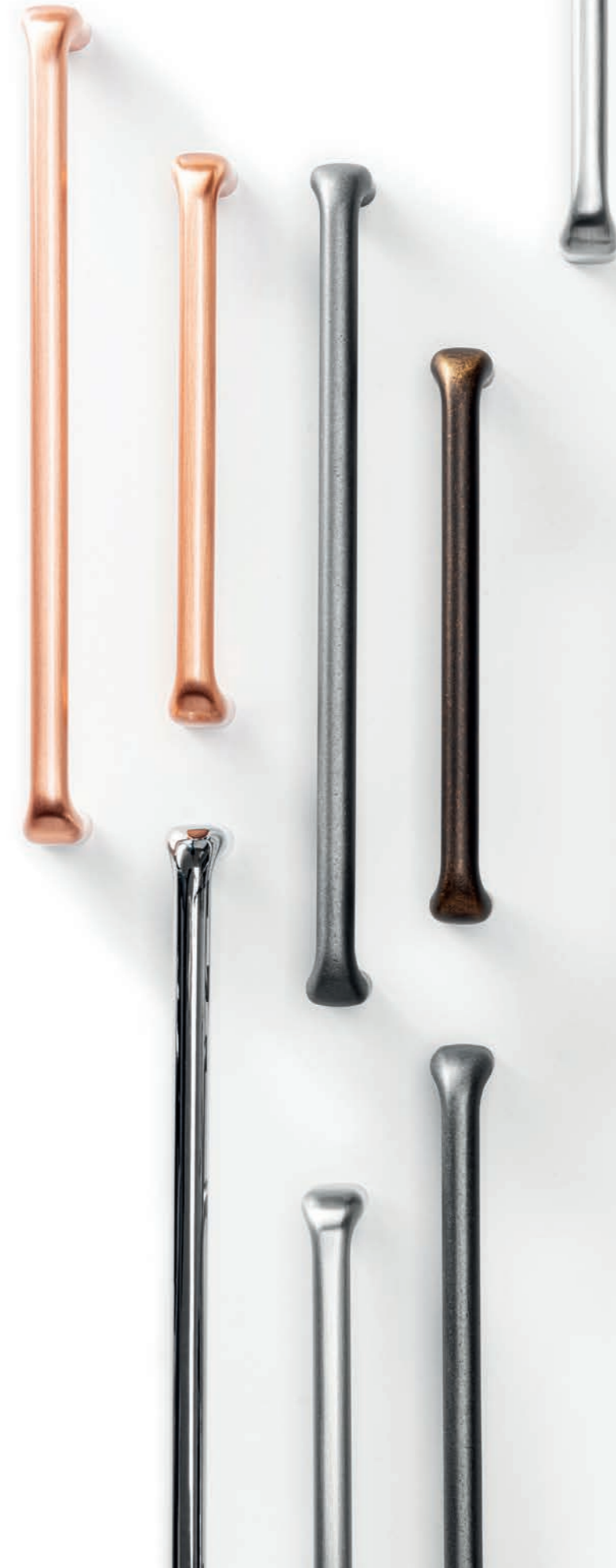

Finishes
Acabados

Antique Brass
Latón antiguo

Polished chrome
Cromo brillo

Brushed nickel
Níquel cepillado

Brushed copper
Cobre cepillado

Pewter
Peltre

←→

o — o

137 mm

128 mm

201 mm

192 mm



Technical info on page 293
Info técnica en pag 293



0405

RAVIOLO

ZAMAK

Designer: Balutto Associati



Finishes
Acabados

Pewter
Peltre

Antique Brass
Latón antiguo

← →

Ø 29 mm

172 mm

○ — ○

-

96 mm



Technical info on page 293
Info técnica en pág 293

0394

AVA

ZAMAK

Designer: Viefe Studio



0390

PETRA

ZAMAK

Designer: Viefe Studio



Finishes
Acabados

Pewter
Peltre

Antique Brass
Latón antiguo

Polished Chrome
Cromo brillo

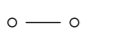

 128,5 mm 96 mm





 Technical info on page 293
Info técnica en pág 293

Finishes
Acabados

Antique copper
Cobre antiguo

Antique silver
Plata antigua

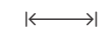
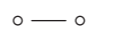
Matt black
Negro mate



 97 mm 64 mm



 Technical info on page 294
Info técnica en pág 294

0392

ORION

ZAMAK

Designer: Viefe Studio



Finishes
Acabados

Antique copper
Cobre antiguo

Antique silver
Plata antigua



136 mm



128 mm



Technical info on page 294
Info técnica en pág 294



0391

AURA

ZAMAK

Designer: Viefe Studio



Finishes
Acabados

Antique copper
Cobre antiguo

Antique silver
Plata antigua



87 mm



64 mm



Technical info on page 294
Info técnica en pág 294





Finishes Acabados

Polished chrome + Beige / Brown / Black
Cromo brillo + Beige / Marrón / Negro

Pewter + Beige / Brown / Black
Peltre + Beige / Marrón / Negro

Matt black + Beige / Brown / Black
Negro mate + Beige / Marrón / Negro

Brushed brass + Beige / Brown / Black
Latón cepillado + Beige / Marrón / Negro

←→	o — o
70 mm	-
150 mm	128 mm
182 mm	160 mm

⊕
Technical info on page 295
Info técnica en pág 295

0239

ARA W

ALUMINIUM + WOOD

Designer: 2J Design



Finishes
Acabados

- Stainless steel look + Oak
- Inox look + Roble
- Stainless steel look + Walnut
- Inox look + Nogal



220 mm
284 mm

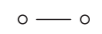

160 mm
224 mm



Technical info on page 295
Info técnica en pág 295



0340

BARCCO

WOOD

Designer: Alexis Vivet



Finishes Acabados

Ash
Fresno

Walnut
Nogal

Beech raw
Haya crudo

K →	o — o 1	o — o 2
200 mm	160 mm	-
400 mm	320 mm	-
600 mm	320 mm	480 mm

⊕
Technical info on page 296
Info técnica en pág 296

0165

CALIN

WOOD

Designer: Viefe Studio



Finishes
Acabados

Raw brushed
Crudo cepillado

White brushed
Blanco cepillado

Brown brushed
Marrón cepillado

Black brushed
Negro cepillado

←→ | o — o
240 mm 160 mm

⊕
Technical info on page 296
Info técnica en pág 296



0166

ECHO

WOOD

Designer: Viefe Studio



Finishes
Acabados

Raw brushed
Crudo cepillado

White brushed
Blanco cepillado

Brown brushed
Marrón cepillado

Black brushed
Negro cepillado



60 mm



Technical info on page 296
Info técnica en pág 296

0167

BALTO

WOOD

Designer: Viefe Studio



Finishes
Acabados

Raw brushed
Crudo cepillado

White brushed
Blanco cepillado

Brown brushed
Marrón cepillado

Black brushed
Negro cepillado

←→ | o — o
60 mm 16 mm



Technical info on page 297
Info técnica en pág 297

0243 ST

LOW ST

ZAMAK

Designer: Viefte Studio



0281

FLAT

ZAMAK

Designer: Oriol Barri



Finishes
Acabados

Polished chrome
Cromo brillo

Brushed nickel
Niquel cepillado

←→	○ — ○
78 mm	64 mm
206 mm	192 mm



⊕
Technical info on page 297
Info técnica en pág 297

Finishes
Acabados

Polished chrome
Cromo brillo

Brushed nickel
Niquel cepillado

←→	○ — ○
174,8 mm	160 mm

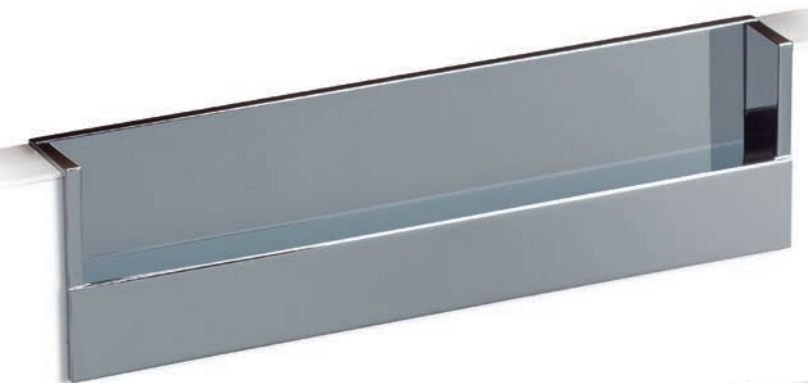

⊕
Technical info on page 297
Info técnica en pág 297

0208

DUA

ZAMAK

Designer: 2J Design



Finishes
Acabados

Polished chrome
Cromo brillo
Brushed nickel
Níquel cepillado



210 mm



192 mm



Technical info on page 298
Info técnica en pág 298



0374

BALL

ZAMAK

Designer: Alexis Vivet



Finishes
Acabados

Polished chrome
Cobre brillo
Brushed nickel
Níquel cepillado
Brushed brass
Latón cepillado



23,3 mm
29,5 mm



Technical info on page 292
Info técnica en pág 292

0376

BOXX

ZAMAK

Designer: Alexis Vivet



0091

RASO

ZAMAK

Designer: Viefe Studio

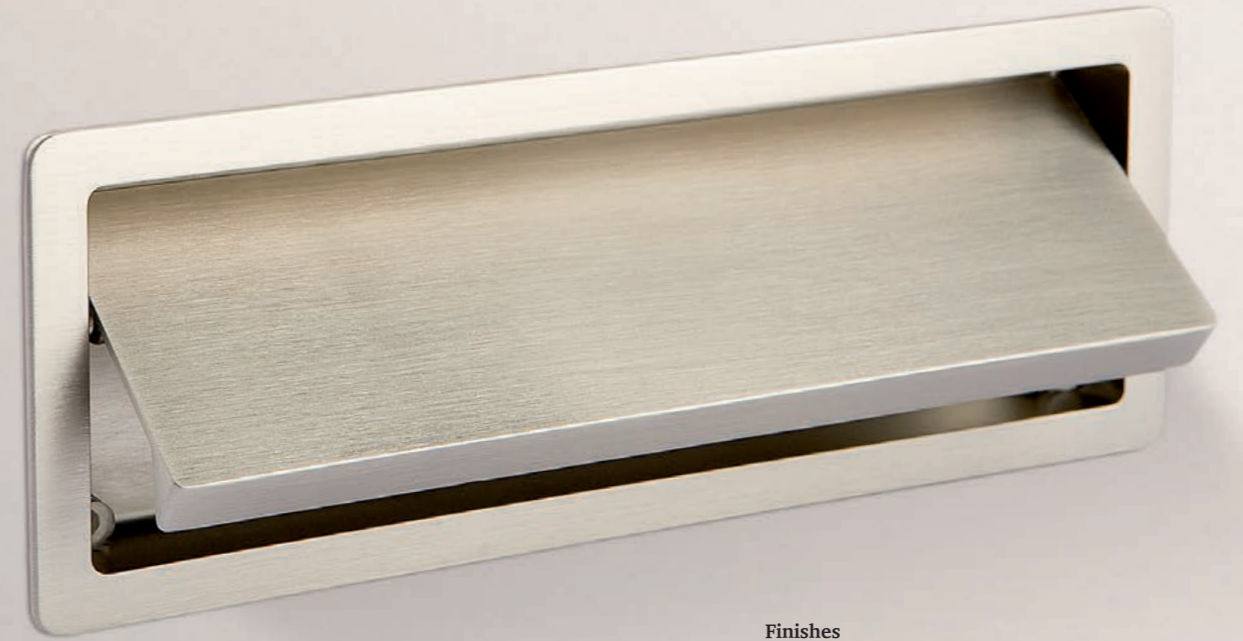

Finishes Acabados

	◀—▶	○ — ○
Brushed nickel <i>Níquel cepillado</i>	70 mm	32 mm
	152,5 mm	108 mm



Technical info on page 298
Info técnica en pág 298



Finishes Acabados

	◀—▶
Polished chrome <i>Cromo brillo</i>	15 mm
Matt chrome <i>Cromo mate</i>	
Brushed nickel <i>Níquel cepillado</i>	
Matt black <i>Negro mate</i>	



Technical info on page 298
Info técnica en pág 298

0312

ARKO

ALUMINIUM

Designer: Viefe Studio



Finishes Acabados

Stainless steel look
Inox look

	◀—▶	○ — ○
	186 mm	160 mm
	218 mm	192 mm
	292 mm	256 mm



Technical info on page 300
Info técnica en pág 300

0369

RITTA

ALUMINIUM

Designer: Teruel & Paré



Finishes
Acabados

Polished chrome
Cromo brillo

Matt black
Negro mate

Stainless steel look
Inox look

↳—	○ — ○
130 mm	64 mm
260 mm	128 mm

⊕
Technical info on page 299
Info técnica en pág 299

0219

ARROW

ZAMAK

Designer: 2J Design



Finishes
Acabados

Polished chrome
Cromo brillo

Brushed nickel
Níquel cepillado

↳—	○ — ○
223 mm	
	192 mm

⊕
Technical info on page 291
Info técnica en pág 291

0249

FERRI

STAINLESS STEEL

Designer: Viefe Studio

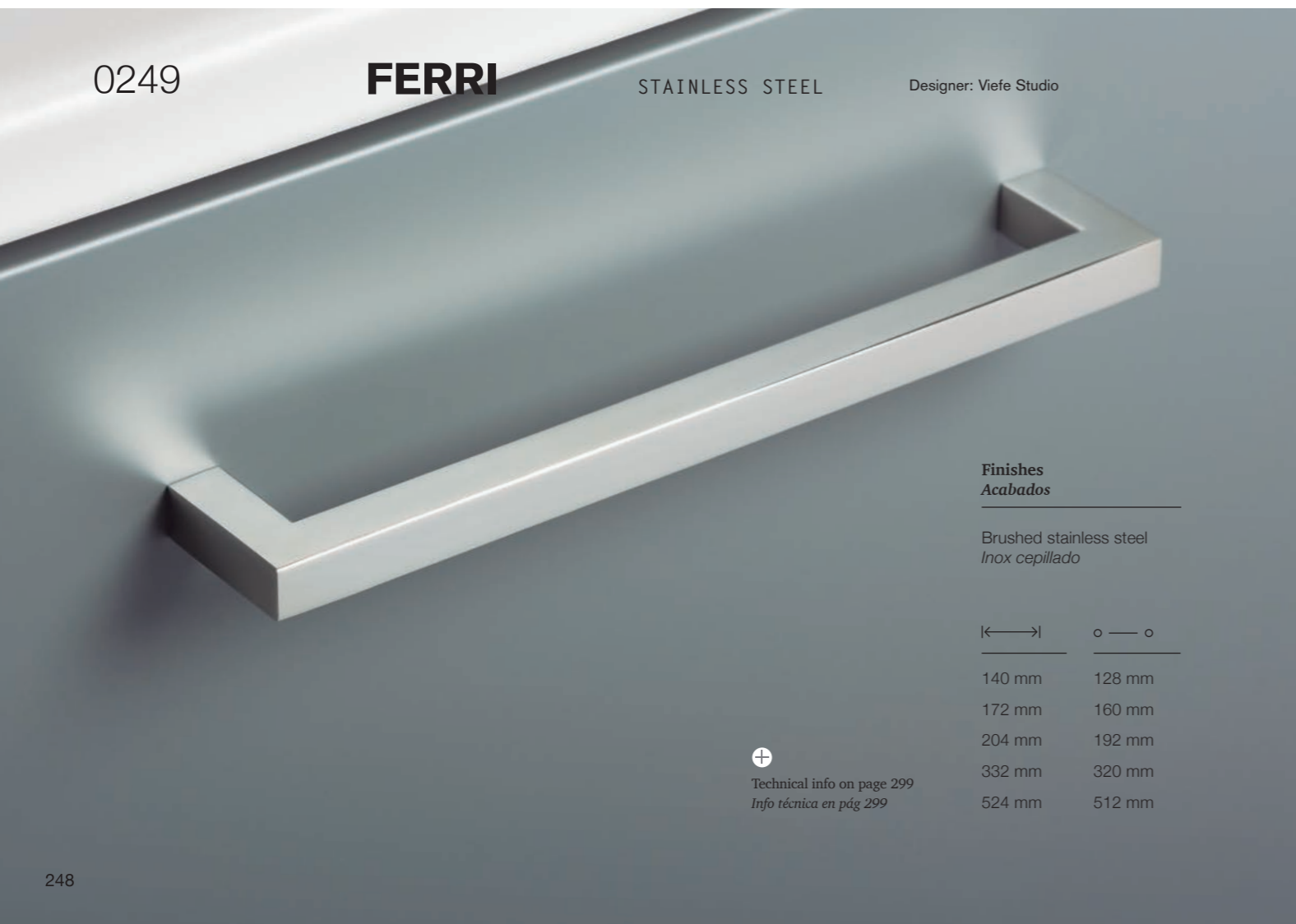

Finishes
Acabados

Brushed stainless steel
Inox cepillado

↳—	○ — ○
140 mm	128 mm
172 mm	160 mm
204 mm	192 mm
332 mm	320 mm
524 mm	512 mm

⊕
Technical info on page 299
Info técnica en pág 299

0076

FORT

STAINLESS STEEL

Designer: Viefe Studio

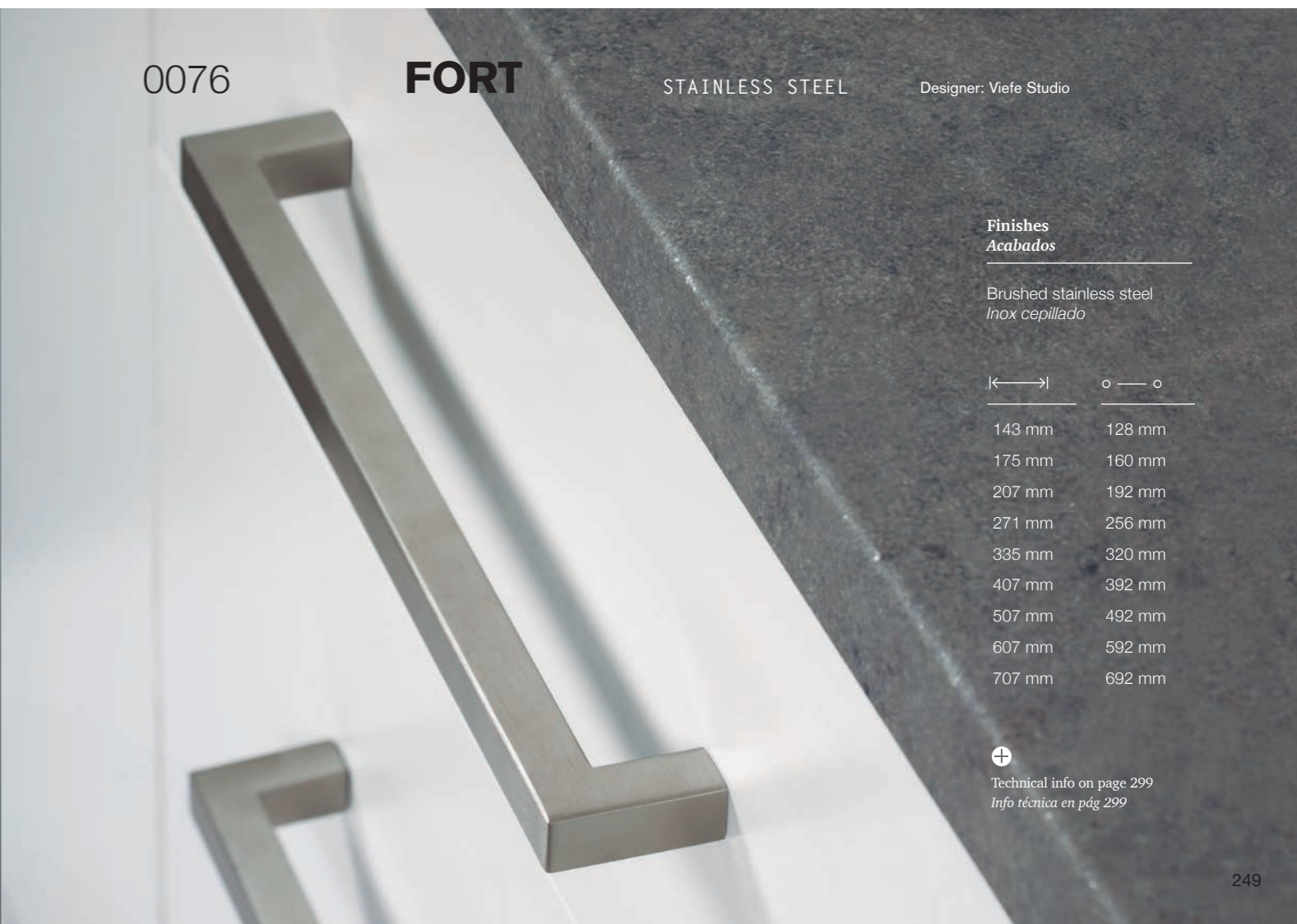

Finishes
Acabados

Brushed stainless steel
Inox cepillado

↳—	○ — ○
143 mm	128 mm
175 mm	160 mm
207 mm	192 mm
271 mm	256 mm
335 mm	320 mm
407 mm	392 mm
507 mm	492 mm
607 mm	592 mm
707 mm	692 mm

⊕
Technical info on page 299
Info técnica en pág 299

0206

ARCH

ZAMAK

Designer: 2J Design

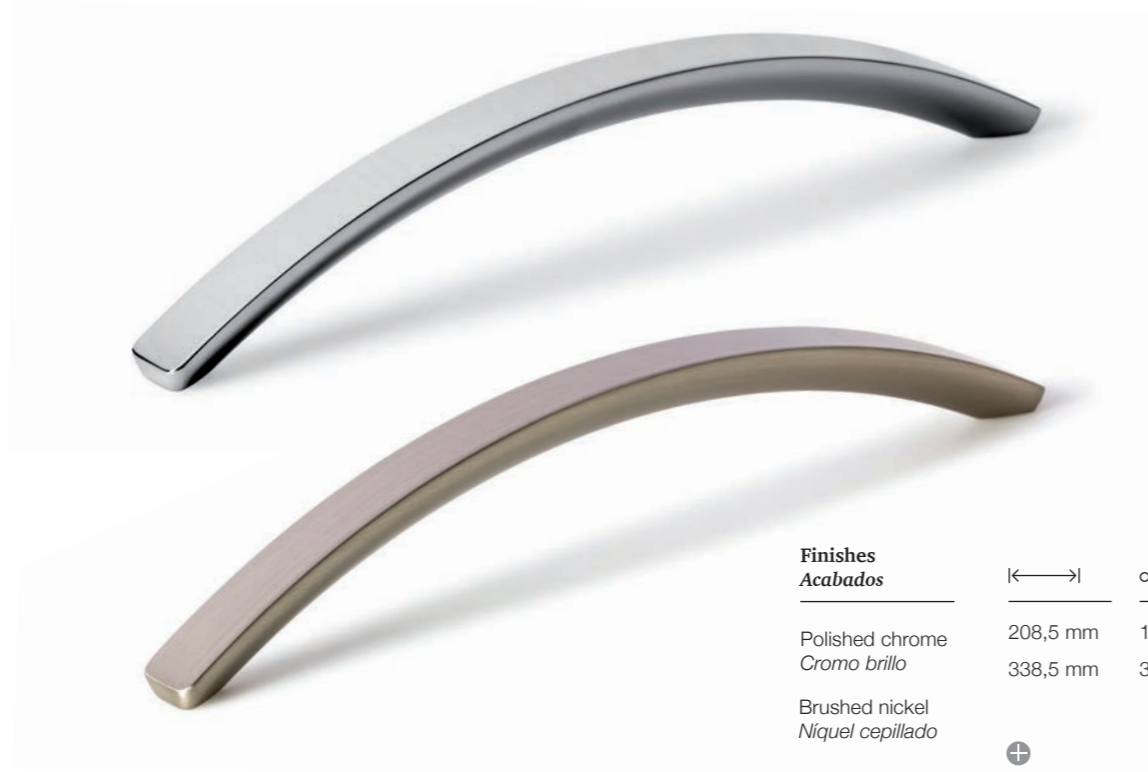

Finishes Acabados	←→	○ — ○
Polished chrome <i>Cromo brillo</i>	208,5 mm	192 mm
Brushed nickel <i>Níquel cepillado</i>	338,5 mm	320 mm

⊕
Technical info on page 283
Info técnica en pág 283

0064

KOMBI

STAINLESS STEEL

Designer: Viefé Studio



Finishes Acabados	←→	○ — ○
Brushed stainless steel <i>Inox cepillado</i>	182 mm	160 mm
	214 mm	192 mm
	314 mm	292 mm
	364 mm	342 mm
	414 mm	392 mm
	514 mm	492 mm
	814 mm	792 mm
	1114 mm	1092 mm

⊕
Technical info on page 300
Info técnica en pág 300

0162

KADO

ZAMAK

Designer: Viefé Studio

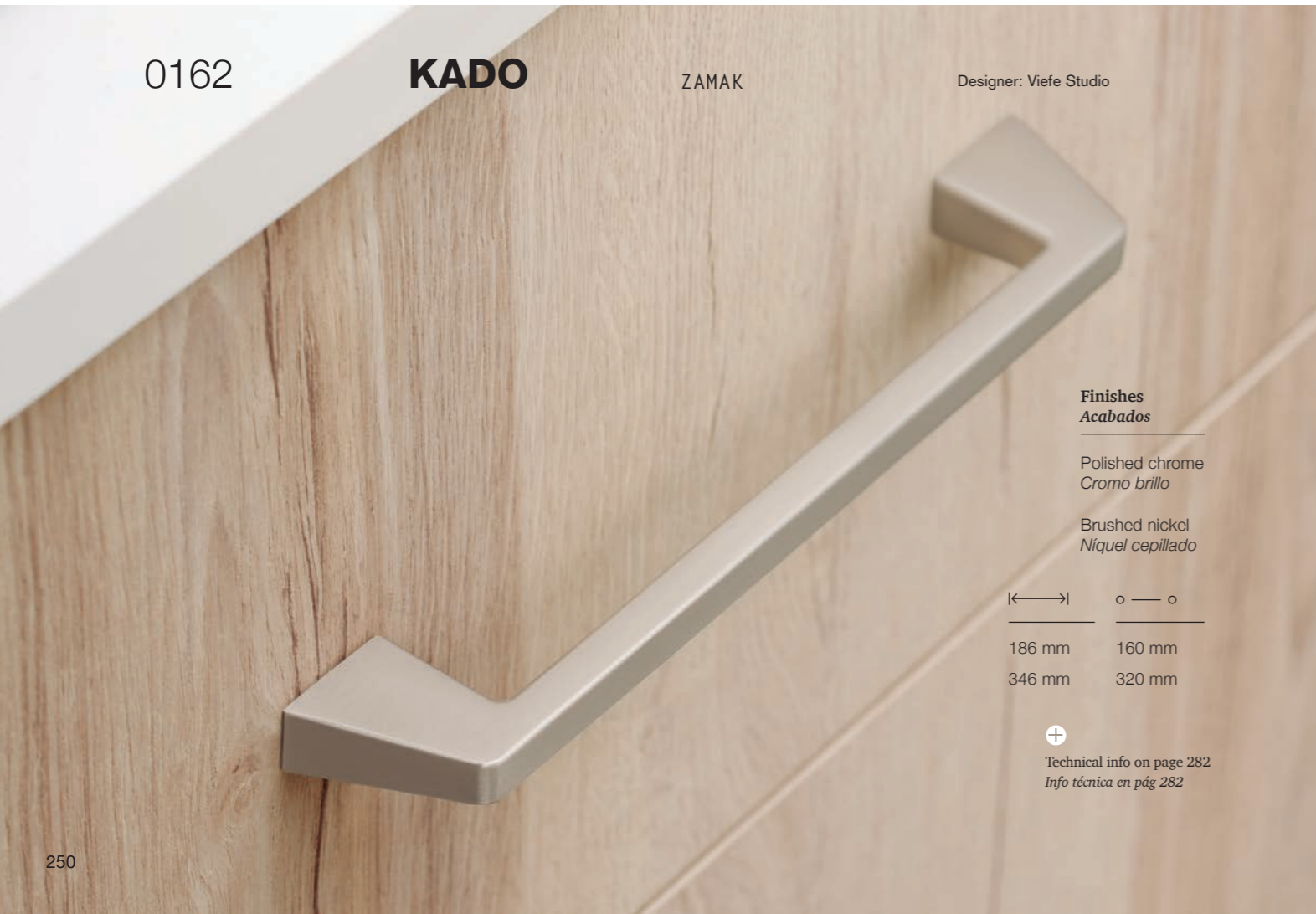

Finishes Acabados	←→	○ — ○
Polished chrome <i>Cromo brillo</i>		
Brushed nickel <i>Níquel cepillado</i>		
	186 mm	160 mm
	346 mm	320 mm

⊕
Technical info on page 282
Info técnica en pág 282

0035

ACER

STAINLESS STEEL

Designer: 2J Design

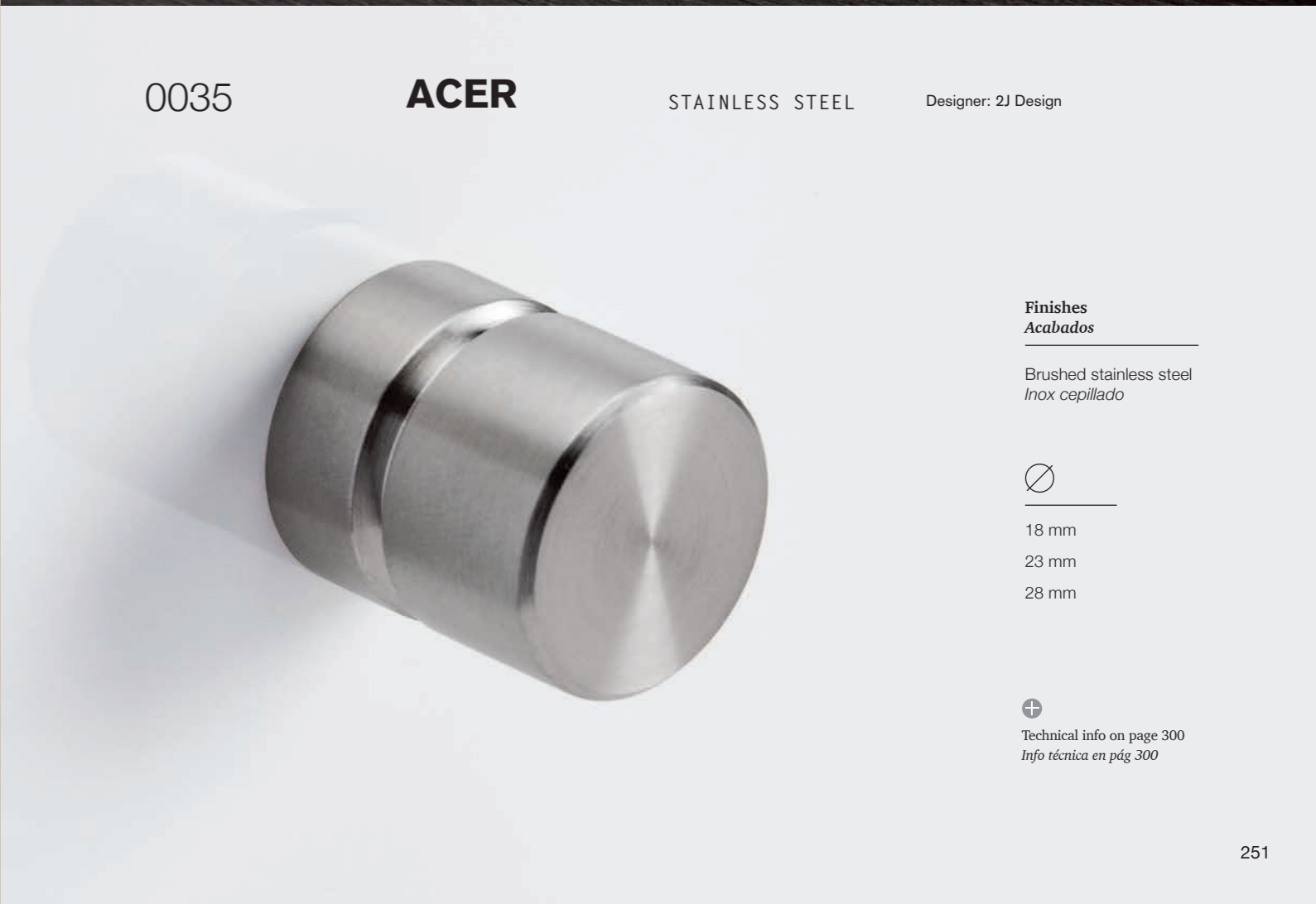

Finishes Acabados	∅
Brushed stainless steel <i>Inox cepillado</i>	
	18 mm
	23 mm
	28 mm

⊕
Technical info on page 300
Info técnica en pág 300

6005

FONDA

ALUMINIUM

Designer: Viefte Studio



Finishes
Acabados

	↕
Polished chrome <i>Cromo brillo</i>	100 mm
Stainless steel look <i>Inox look</i>	150 mm
Brushed dark brass <i>Latón oscuro cepillado</i>	200 mm
Brushed black <i>Negro cepillado</i>	



Technical info on page 301
Info técnica en pág 301

Viefe[®]

TECH- NICAL *Info*

—
**Información
técnica**

—
**Informació
tècnica**

0590 **BELT** ZAMAK Designer: Kaschkasch

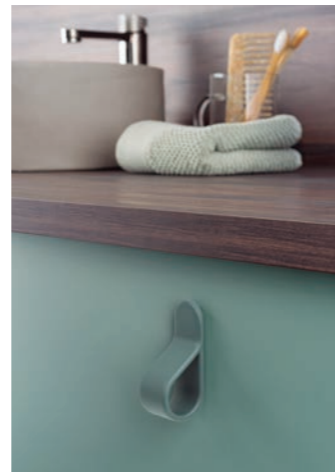
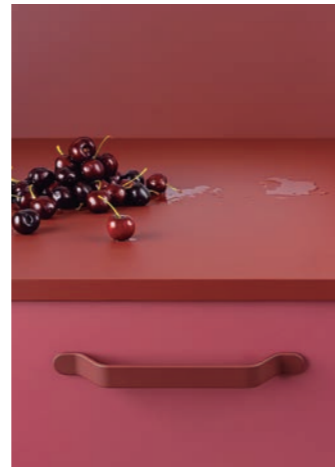
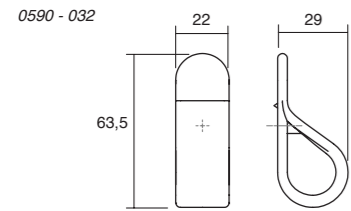
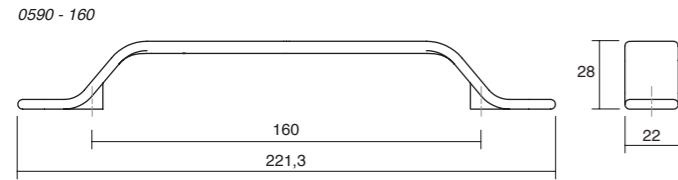

ZM1	ZM2	ZM25	ZM31	ZM43	ZM72	↓	☐
Matt white <i>Blanco mate</i>	Matt black <i>Negro mate</i>	Moss grey <i>Gris musgo</i>	Green forest <i>Verde forest</i>	Brown mocca <i>Marrón mocca</i>	Red volcano <i>Rojo volcano</i>		
0590022ZM1	0590022ZM2	0590022ZM25	0590022ZM31	0590022ZM43	0590022ZM72	1	25
0590160ZM1	0590160ZM2	0590160ZM25	0590160ZM31	0590160ZM43	0590160ZM72	2	25

Includes non-twisting tip
Incluye punta anti-giro

0597 **PLIÉ** ZAMAK Designer: Teruel & Paré

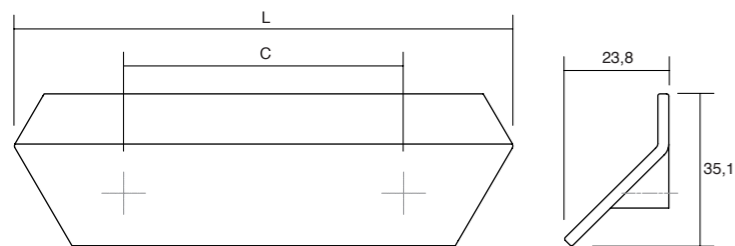

ZM2	ZM23	ZM41	C	L	↓	☐
Matt black <i>Negro mate</i>	Metal grey <i>Gris metal</i>	Metal brown <i>Marrón metal</i>				
0597064ZM2	0597064ZM23	0597064ZM41	64	114	2	25
0597160ZM2	0597160ZM23	0597160ZM41	160	210	2	25

0600 **WING** ALUMINIUM Designer: Alexis Vivet

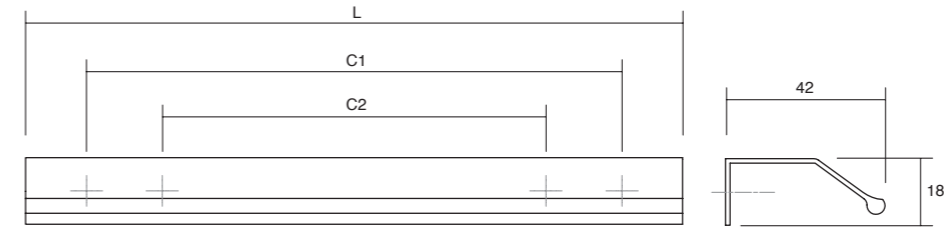

L24	L30	L613	L618	C1	C2	L	↓	☐
Stainless steel look <i>Inox look</i>	Brushed black <i>Negro cepillado</i>	Antique bronze <i>Bronce antiguo</i>	Brushed brass cava <i>Latón cava cepillado</i>					
0600064L24	0600064L30	0600064L613	0600064L618	64	-	100	2	25
0600128L24	0600128L30	0600128L613	0600128L618	128	-	200	2	25
0600256L24	0600256L30	0600256L613	0600256L618	256	-	350	2	25
06001120L24	06001120L30	06001120L613	06001120L618	1120	384	1200	4	15



0591 **ETO** ALUMINIUM + WOOD Designer: Kaschkasch

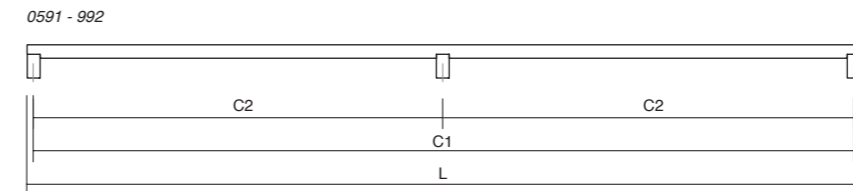
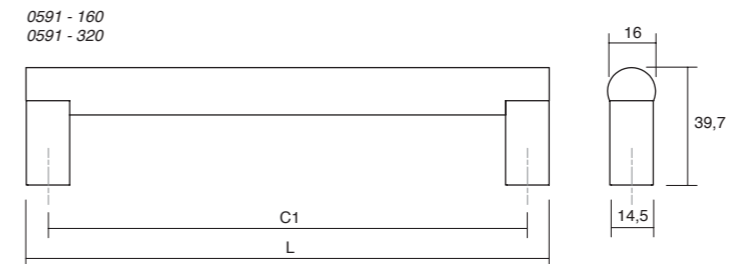

NM2716 (LM27+W16)	NM2717 (LM27+W17)	NM2M2 (LM2+WM2)	C1	C2	L	↓	☐
Lava grey + Oak <i>Gris lava + roble</i>	Lava grey + Walnut <i>Gris lava + Nogal</i>	Matt black + Ash matt black lacquered <i>Negro mate + Fresno lacado negro mate</i>					
0591160NM2716	0591160NM2717	0591160NM2M2	160	-	174,6	2	25
0591320NM2716	0591320NM2717	0591320NM2M2	320	-	334,6	2	25
0591992NM2716	0591992NM2717	0591992NM2M2	992	496	1006,6	3	15



0610 **FLAPP Aluminium** ALUMINIUM Designer: Frank Person

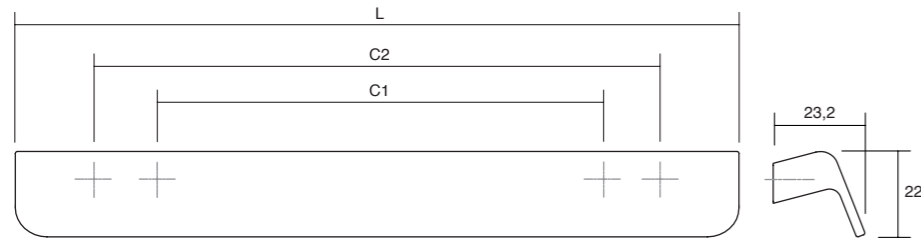

L24	L30	L618	C1	C2	L	↓	☐
Stainless steel look <i>Inox look</i>	Brushed black <i>Negro cepillado</i>	Brushed brass cava <i>Latón cava cepillado</i>					
0610032L24	0610032L30	0610032L618	32	-	70	2	25
0610160L24	0610160L30	0610160L618	128	160	200	4	25
0610256L24	0610256L30	0610256L618	256	-	350	2	25
06101056L24	06101056L30	06101056L618	416	1056	1100	4	15

0613 **FLAPP Wood** WOOD Designer: Frank Person

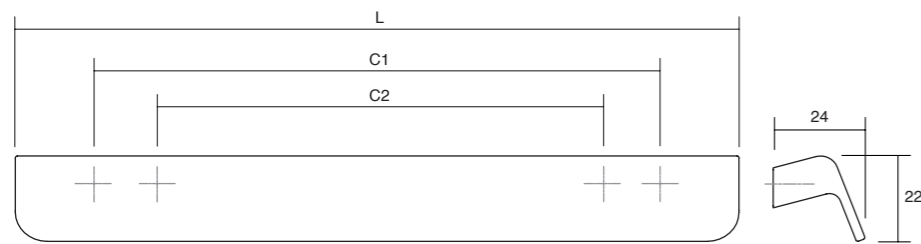

W16	W17	C1	C2	L	↓	☐
Oak <i>Roble</i>	Walnut <i>Nogal</i>					
0613032W16	0613032W17	32	-	70	2	25
0613160W16	0613160W17	160	-	200	2	25
06131056W16	06131056W17	1056	416	1100	4	15

0601 **OH! Wood** WOOD Designer: Alexis Vivet

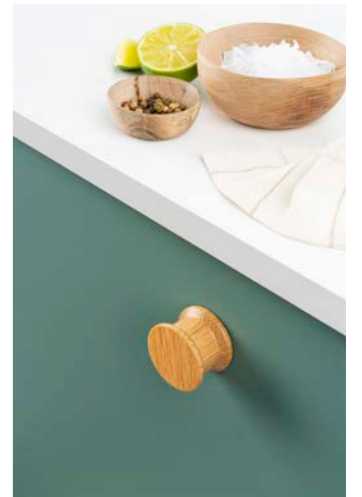
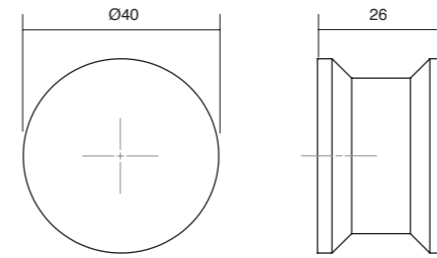

W16	W17	WM2	↓	☐
Oak <i>Roble</i>	Walnut <i>Nogal</i>	Ash matt black lacquered <i>Fresno lacado negro mate</i>		
0601040W16	0601040W17	0601040WM2	1	25

0601 **OH! Zamak** ZAMAK Designer: Alexis Vivet

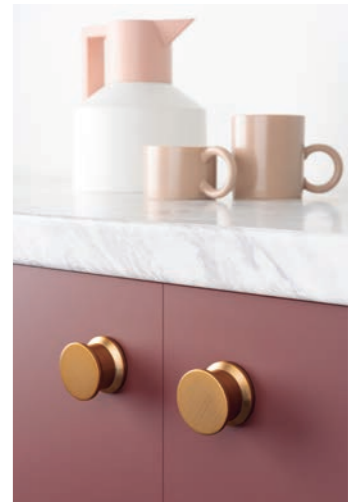
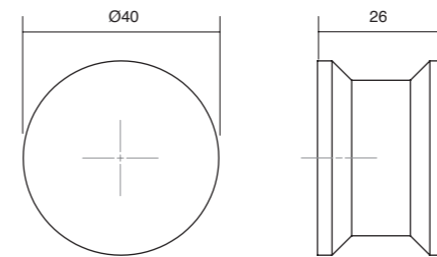

Z23	Z618	ZM2	↓	☐
Brushed nickel <i>Níquel cepillado</i>	Brushed brass cava <i>Latón cava cepillado</i>	Matt black <i>Negro mate</i>		
0601040Z23	0601040Z618	0601040ZM2	1	25

0602 **VALLEY** ZAMAK Designer: Alexis Vivet

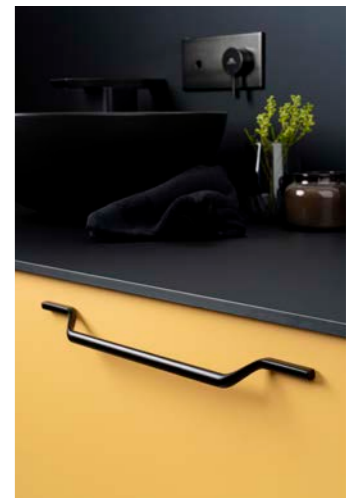
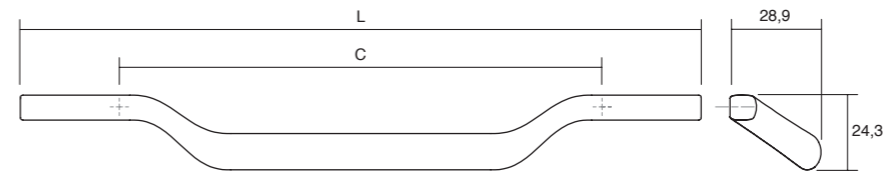

Z03	Z07	Z618	ZM2	C	L	↓	☐
Polished black nickel <i>Níquel negro brillo</i>	Polished brass <i>Latón brillo</i>	Brushed brass cava <i>Latón cava cepillado</i>	Matt black <i>Negro mate</i>				
0602160Z03	0602160Z07	0602160Z618	0602160ZM2	160	223	2	25
0602256Z03	0602256Z07	0602256Z618	0602256ZM2	256	330	2	25

0604 **PRISMA** ZAMAK Designer: Alexis Vivet

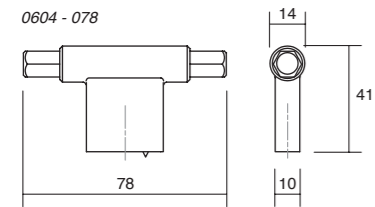
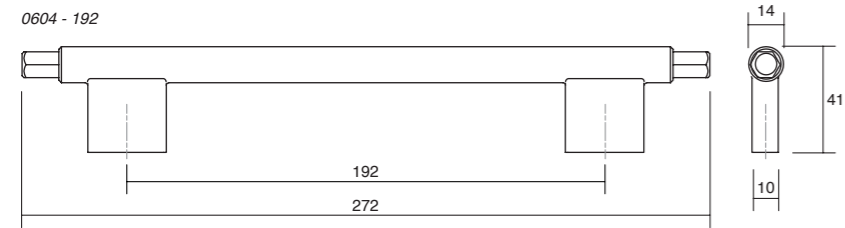

ZM2	Z623			
Matt black	Rustic brass	↓	↓	↓
Negro mate	Latón rústico			
0604078ZM2	0604078Z623	1	25	Includes non-twisting tip Incluye punta anti-giro
0604192ZM2	0604192Z623	2	15	



0528 **RILLE** ALUMINIUM Designer: Patricia Roig

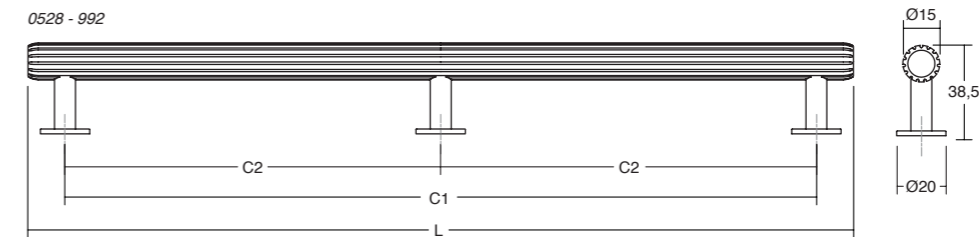
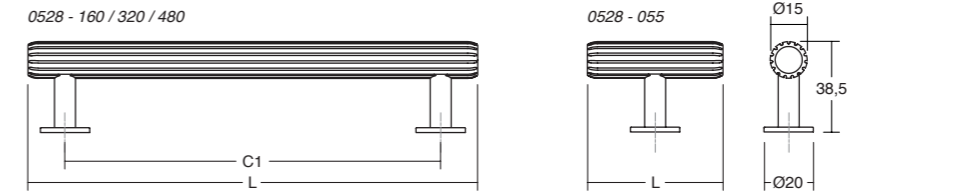

L24	L291	L30	C1	C2	L	↓	↓
Stainless steel look Inox look	Brushed brass Latón cepillado	Brushed black Negro cepillado					
0528055L24	0528055L291	0528055L30	-	-	55	1	25
0528160L24	0528160L291	0528160L30	160	-	190	2	25
0528320L24	0528320L291	0528320L30	320	-	350	2	25
0528480L24	0528480L291	0528480L30	480	-	510	2	25
0528992L24	0528992L291	0528992L30	992	496	1022	3	15

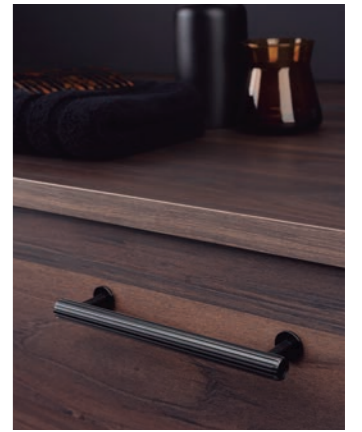
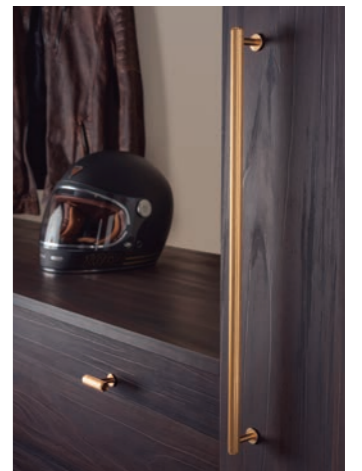

0608 **QUART Mini** ZAMAK Designer: Frank Person

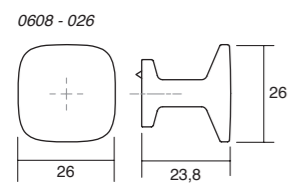
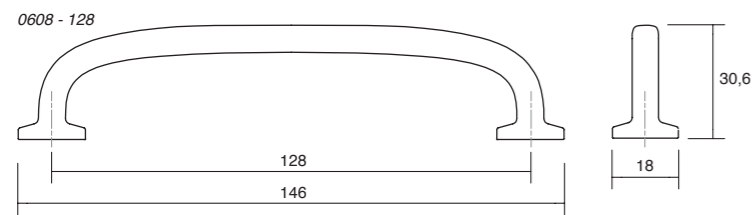

Z618	Z623	ZM2		
Brushed brass cava	Rustic brass	Matt black	↓	↓
Latón cava cepillado	Latón rústico	Negro mate		
0608026Z618	0608026Z623	0608026ZM2	1	25
0608128Z618	0608128Z623	0608128ZM2	2	25

Includes non-twisting tip
Incluye punta anti-giro



0536 **LUV** ZAMAK Designer: Kaschkasch

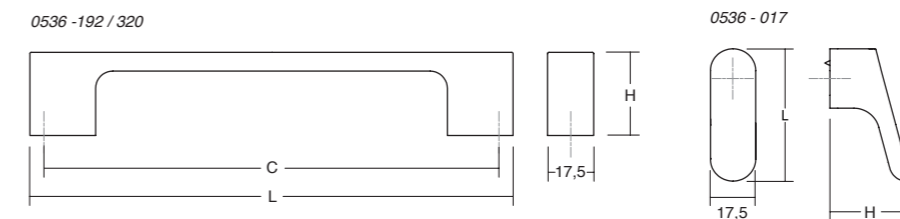

Z23	Z618 NEW!	ZM1	ZM2	C	L	H	↓	↓
Brushed nickel	Brushed brass cava	Matt white	Matt black					
Níquel cepillado	Latón cava cepillado	Blanco mate	Negro mate					
0536017Z23	0536017Z618	0536017ZM1	0536017ZM2	-	51,2	31,1	1	25
0536192Z23	0536192Z618	0536192ZM1	0536192ZM2	192	202	30,4	2	25
0536320Z23	0536320Z618	0536320ZM1	0536320ZM2	320	330	30,4	2	25

Includes non-twisting tip / Incluye punta anti-giro



0616 **QUART Big** ZAMAK Designer: Frank Person

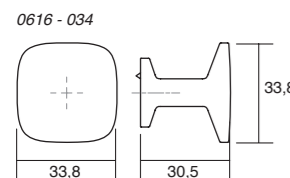
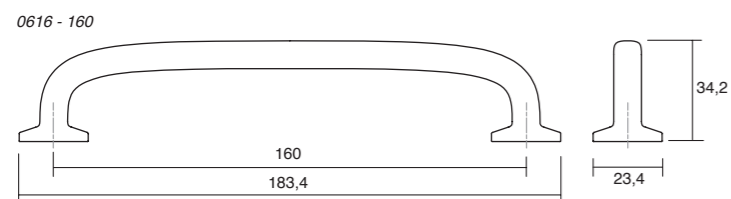

Z618	Z623	ZM2		
Brushed brass cava	Rustic brass	Matt black	↓	↓
Latón cava cepillado	Latón rústico	Negro mate		
0616034Z618	0616034Z623	0616034ZM2	1	25
0616160Z618	0616160Z623	0616160ZM2	2	25

Includes non-twisting tip
Incluye punta anti-giro



0614 **EQUIS**

ZAMAK

Designer: Patricia Roig

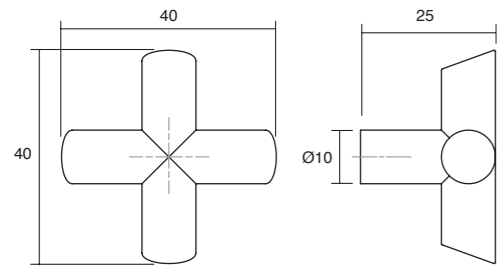

Z01	Z03	Z06	Z07	ZM1	ZM2		
Polished chrome	Polished black nickel	Polished copper	Polished brass	Matt white	Matt black	↓	☐
<i>Cromo brillo</i>	<i>Níquel negro brillo</i>	<i>Cobre brillo</i>	<i>Latón brillo</i>	<i>Blanco mate</i>	<i>Negro mate</i>		
0614040Z01	0614040Z03	0614040Z06	0614040Z07	0614040ZM1	0614040ZM2	1	25

0538 **CONIC**

WOOD

Designer: Kaschkasch

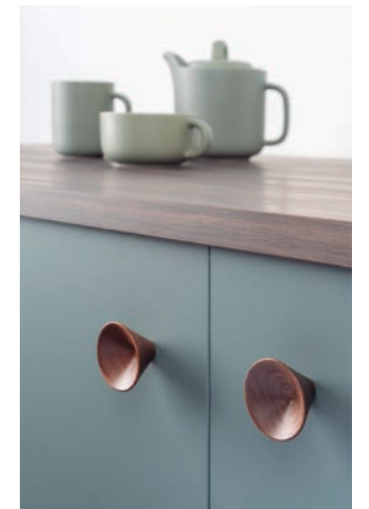
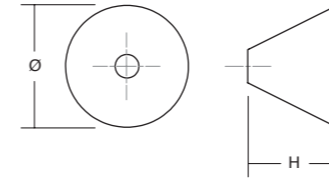

W16	W17	WM2	Ø	H	↓	☐
Oak	Walnut	Ash matt black lacquered				
<i>Roble</i>	<i>Nogal</i>	<i>Fresno lacado negro mate</i>				
0538029W16	0538029W17	0538029WM2	29,4	22	1	25
0538043W16	0538043W17	0538043WM2	43	25	1	25

0530 **DISC**

WOOD

Designer: Balutto Associati

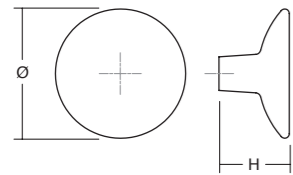

W16	W17	WM2	Ø	H	↓	☐
Oak	Walnut	Ash matt black lacquered				
<i>Roble</i>	<i>Nogal</i>	<i>Fresno lacado negro mate</i>				
0530038W16	0530038W17	0530038WM2	38	20,4	1	25
0530050W16	0530050W17	0530050WM2	50	27	1	25

0538 **CONIC**

ZAMAK

Designer: Kaschkasch

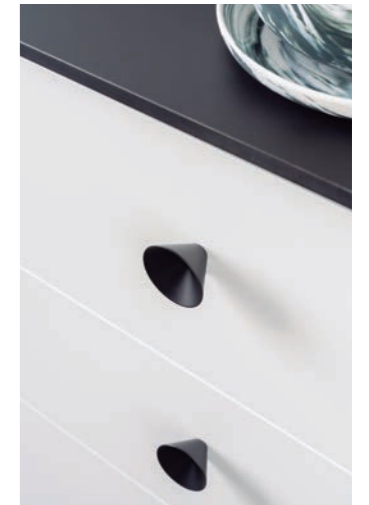
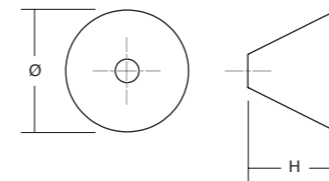

ZM1	ZM2	ZM25	Ø	H	↓	☐
Matt white	Matt black	Moss grey				
<i>Blanco mate</i>	<i>Negro mate</i>	<i>Gris musgo</i>				
0538029ZM1	0538029ZM2	0538029ZM25	29,4	22	1	25
0538043ZM1	0538043ZM2	0538043ZM25	43	25	1	25

0530 **DISC**

ZAMAK

Designer: Balutto Associati

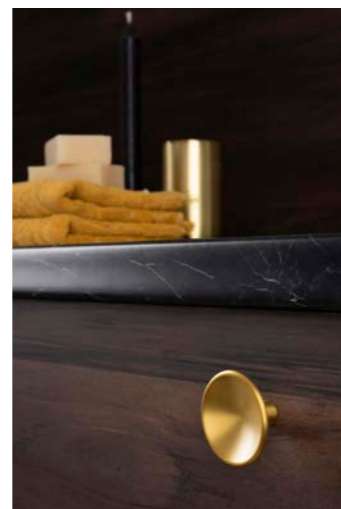
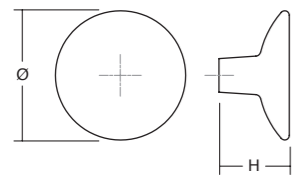

Z23	Z618 NEW!	ZM1	ZM2	Ø	H	↓	☐
Brushed nickel	Brushed brass cava	Matt white	Matt black				
<i>Níquel cepillado</i>	<i>Latón cava cepillado</i>	<i>Blanco mate</i>	<i>Negro mate</i>				
0530038Z23	0530038Z618	0530038ZM1	0530038ZM2	38	20,4	1	25
0530050Z23	0530050Z618	0530050ZM1	0530050ZM2	50	27	1	25

0556 **DIPO**

ZAMAK

Designer: Bernat Llorch

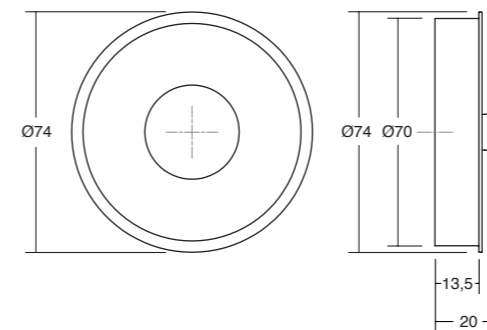

ZM1	ZM2	ZM25	↓	☐
Matt white	Matt black	Moss grey		
<i>Blanco mate</i>	<i>Negro mate</i>	<i>Gris musgo</i>		
0556070ZM1	0556070ZM2	0556070ZM25	1	25

0543 **SOFT** ZAMAK Designer: Uli Budde

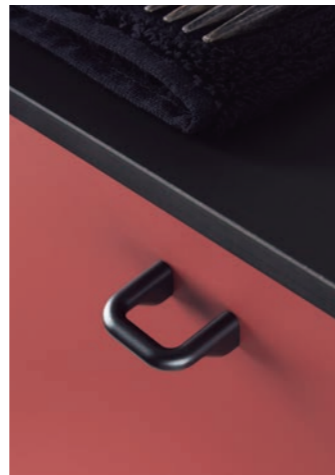
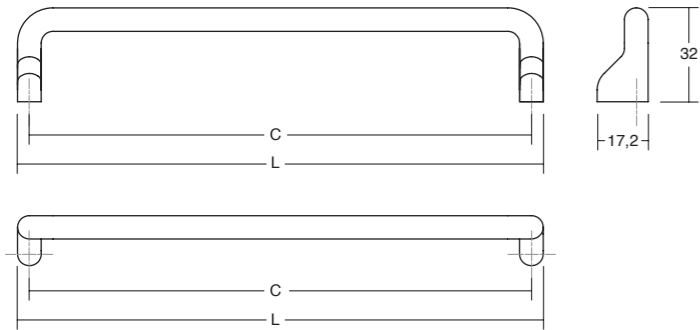

ZM1	ZM2	ZM25	C	L	↓	☐
Matt white <i>Blanco mate</i>	Matt black <i>Negro mate</i>	Moss grey <i>Gris musgo</i>				
0543032ZM1	0543032ZM2	0543032ZM25	32	40	2	25
0543192ZM1	0543192ZM2	0543192ZM25	192	200	2	25
0543320ZM1	0543320ZM2	0543320ZM25	320	328	2	25

0553 **OTO** ZAMAK Designer: Bernat Llorch

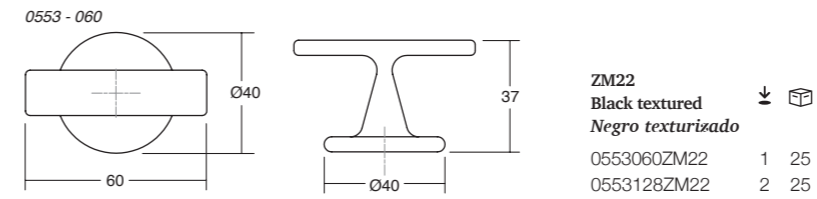
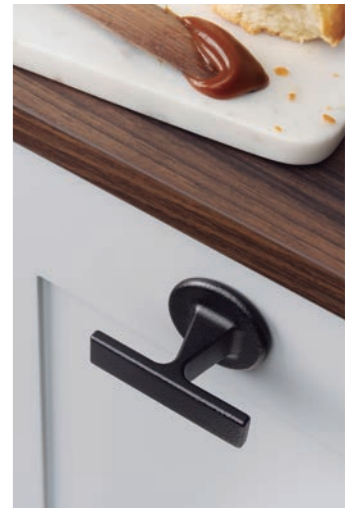
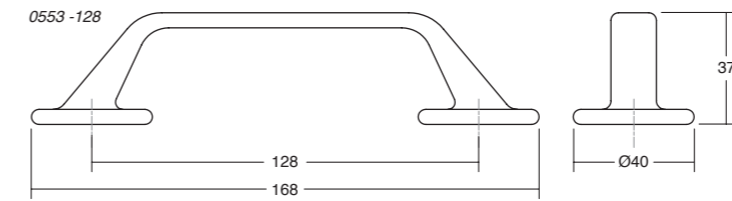

0542 **FOLD** ZAMAK Designer: Teruel & Paré

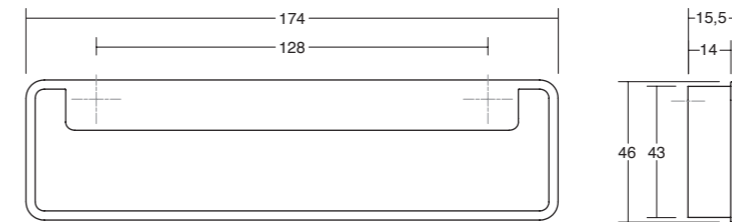

Z23	Z618 NEW!	ZM1	ZM2	↓	☐
Brushed nickel <i>Níquel cepillado</i>	Brushed brass cava <i>Latón cava cepillado</i>	Matt white <i>Blanco mate</i>	Matt black <i>Negro mate</i>		
0542128Z23	0542128Z618	0542128ZM1	0542128ZM2	2	25

0552 **RIM** ZAMAK Designer: Bernat Llorch

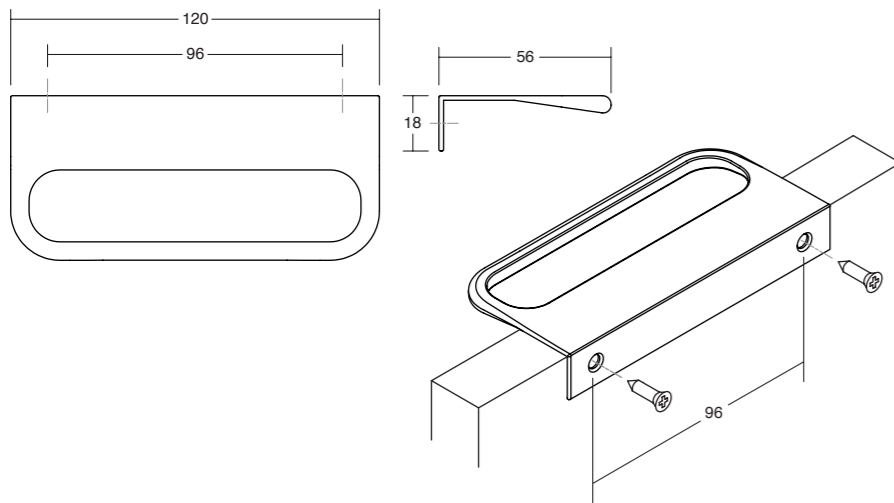

Z23	Z618 NEW!	ZM1	ZM2	ZM25	↓	☐
Brushed nickel <i>Níquel cepillado</i>	Brushed brass cava <i>Latón cava cepillado</i>	Matt white <i>Blanco mate</i>	Matt black <i>Negro mate</i>	Moss grey <i>Gris musgo</i>		
0552096Z23	0552096Z618	0552096ZM1	0552096ZM2	0552096ZM25	2	25



0588 **ARPA PLATE** ALUMINIUM Designer: Viefe Studio

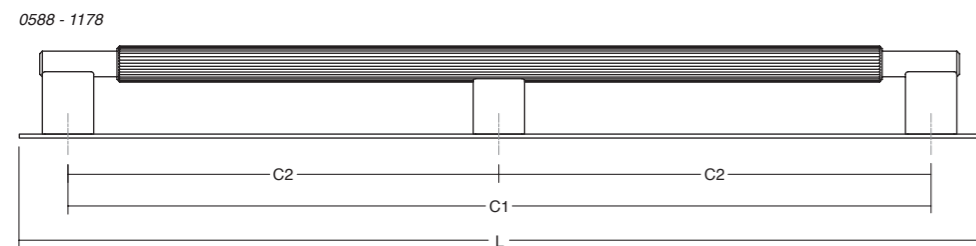
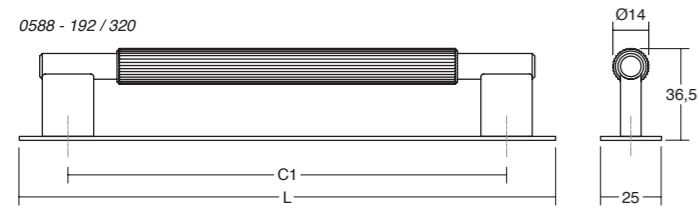
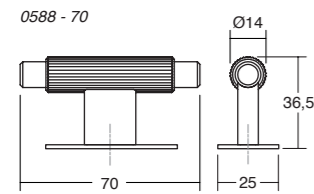
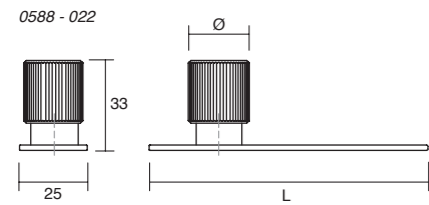

0583 **ARPA** ALUMINIUM Designer: Viefe Studio

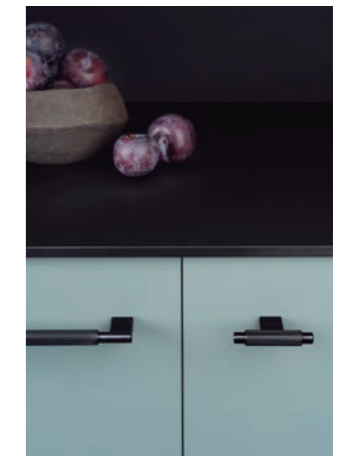
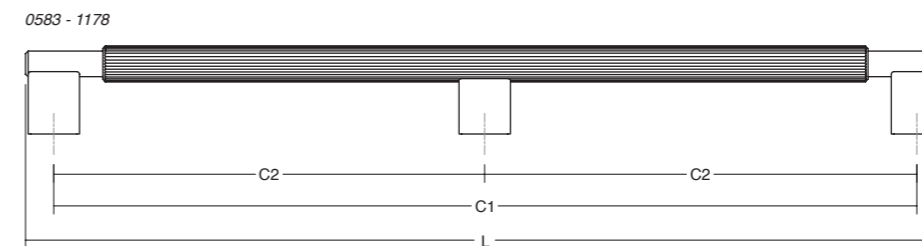
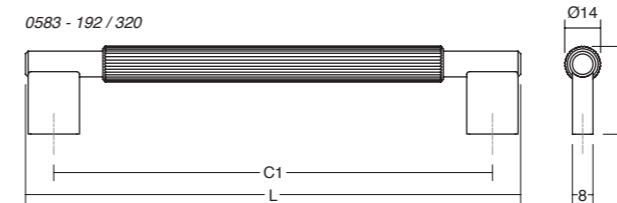
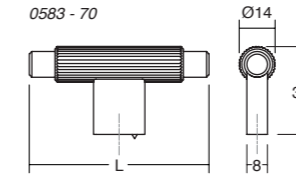
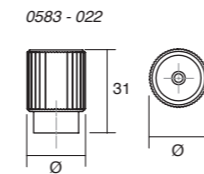

	L24 Stainless steel look Inox look	L291 Brushed brass Latón cepillado	L30 Brushed black Negro cepillado	L623 NEW! Antique brass Latón antiguo	C1	C2	L	Ø	↓	⊞
NEW! 0588022L24	0588022L291	0588022L30	0588022L623	-	-	100	22	1	25	
0588070L24	0588070L291	0588070L30	0588070L623	-	-	70	-	1	25	
0588192L24	0588192L291	0588192L30	0588192L623	192	-	230	-	2	25	
0588320L24	0588320L291	0588320L30	-	320	-	358	-	2	25	
05881178L24	05881178L291	05881178L30	-	1178	589	1216	-	3	10	

	L24 Stainless stl. look Inox look	L291 Brushed brass Latón cepillado	L30 Brushed black Negro cepillado	L623 NEW! Rustic brass Latón rústico	C1	C2	L	Ø	↓	⊞
NEW! 0583022L24	0583022L291	0583022L30	0583022L623	-	-	-	22	1	25	
0583070L24	0583070L291	0583070L30	0583070L623	-	-	70	-	1	25	
0583192L24	0583192L291	0583192L30	0583192L623	192	-	214	-	2	25	
0583320L24	0583320L291	0583320L30	-	320	-	342	-	2	25	
05831178L24	05831178L291	05831178L30	-	1178	589	1200	-	3	10	

Includes non-twisting tip
Incluye punta anti-giro

0495 **FLOID** ZAMAK Designer: Frank Person

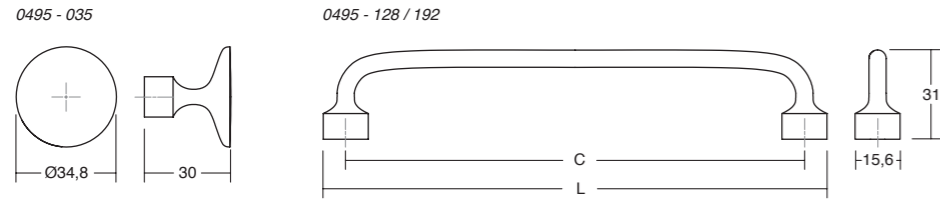

Z28	Z610	Z614	ZM2	C	L	↓	☐
Brushed gold Oro cepillado	Pewter Peltre	Antique brass Latón antiguo	Matt black Negro mate	-	-	1	25
0495035Z28	0495035Z610	0495035Z614	0495035ZM2	-	-	1	25
0495128Z28	0495128Z610	0495128Z614	0495128ZM2	128	143,6	2	25
0495192Z28	0495192Z610	0495192Z614	0495192ZM2	192	207,6	2	25



0496 **BAU** ZAMAK Designer: Patricia Roig

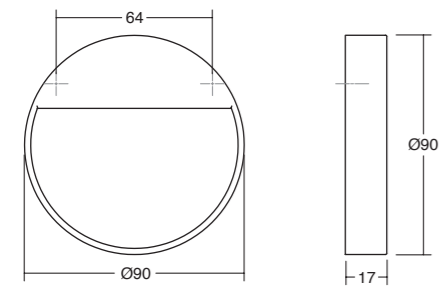

Z23	Z28	ZM2	↓	☐
Brushed nickel Níquel cepillado	Brushed gold Oro cepillado	Matt black Negro mate	2	25
0496064Z23	0496064Z28	0496064ZM2	2	25

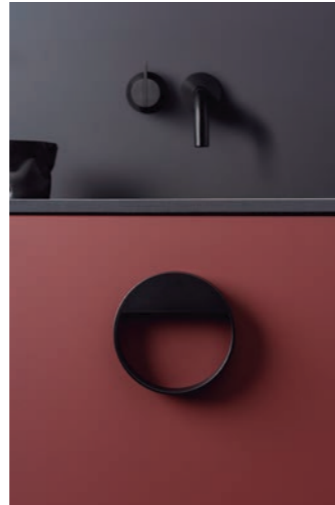

0487 **PURA** ZAMAK Designer: Balutto Associati

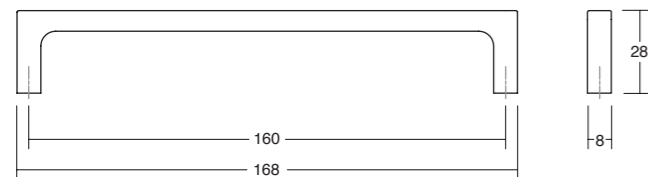

Z01	Z03	Z06	Z07	↓	☐
Polished chrome Cromo brillo	Polished black nickel Níquel negro brillo	Polished copper Cobre brillo	Polished brass Latón brillo	2	25
0487160Z01	0487160Z03	0487160Z06	0487160Z07	2	25



0127 **JEY** ALUMINIUM Designer: Viefe Studio

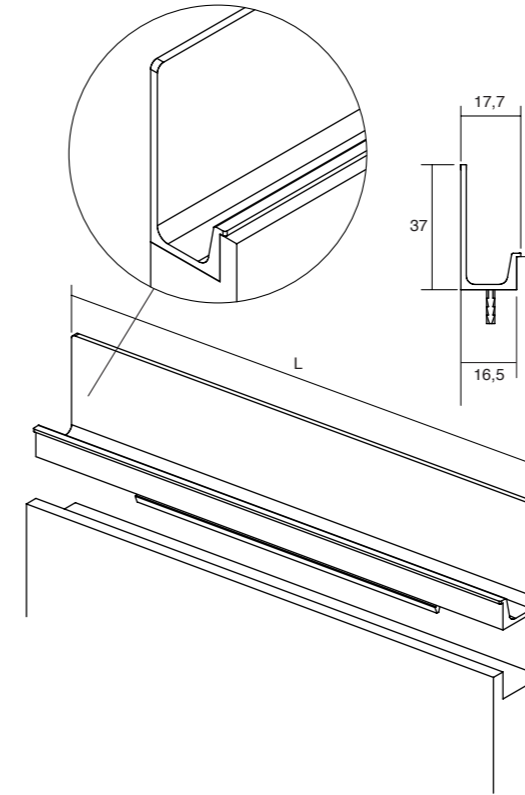

L24	L618	LM1	LM2	L	☐
Stainless steel look Inox look	Brushed brass cava Latón cava cepillado	Matt white Blanco mate	Matt black Negro mate		
0127147L24	0127147L618	0127147LM1	0127147LM2	147	15
0127197L24	0127197L618	0127197LM1	0127197LM2	197	15
0127247L24	0127247L618	0127247LM1	0127247LM2	247	15
0127297L24	0127297L618	0127297LM1	0127297LM2	297	15
0127347L24	0127347L618	0127347LM1	0127347LM2	347	15
0127397L24	0127397L618	0127397LM1	0127397LM2	397	15
0127447L24	0127447L618	0127447LM1	0127447LM2	447	10
0127497L24	0127497L618	0127497LM1	0127497LM2	497	10
0127597L24	0127597L618	0127597LM1	0127597LM2	597	10
0127697L24	0127697L618	0127697LM1	0127697LM2	697	10
0127797L24	0127797L618	0127797LM1	0127797LM2	797	10
0127897L24	0127897L618	0127897LM1	0127897LM2	897	5
0127997L24	0127997L618	0127997LM1	0127997LM2	997	5
01271197L24	01271197L618	01271197LM1	01271197LM2	1197	5
-	-	01273000LM1	01273000LM2	3000	15 *

*Available only in M1 and M2 finishes. Three metre profiles are delivered according to the units of the original packaging and cannot be sold separately. / Disponible solo en los acabados M1 y M2. Las barras de tres metros se sirven según las cantidades del embalaje original y no se pueden servir por separado.



0163 **JEY2** ALUMINIUM Designer: Viefe Studio

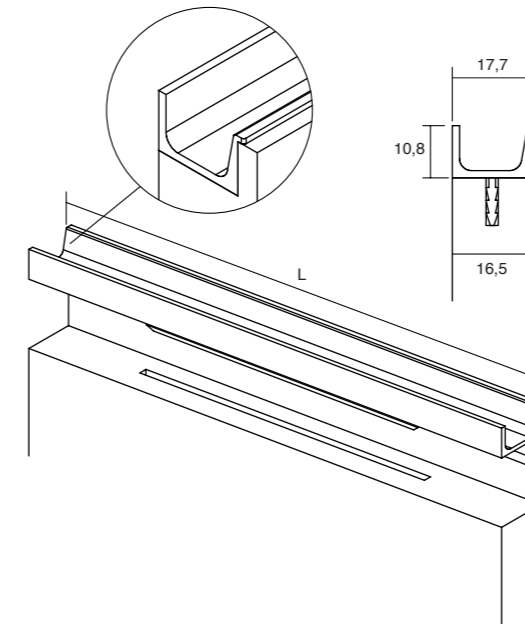

L24	L618	LM1	LM2	L	☐
Stainless steel look Inox look	Brushed brass cava Latón cava cepillado	Matt white Blanco mate	Matt black Negro mate		
0163147L24	0163147L618	0163147LM1	0163147LM2	147	15
0163197L24	0163197L618	0163197LM1	0163197LM2	197	15
0163247L24	0163247L618	0163247LM1	0163247LM2	247	15
0163297L24	0163297L618	0163297LM1	0163297LM2	297	15
0163347L24	0163347L618	0163347LM1	0163347LM2	347	15
0163397L24	0163397L618	0163397LM1	0163397LM2	397	15
0163447L24	0163447L618	0163447LM1	0163447LM2	447	10
0163497L24	0163497L618	0163497LM1	0163497LM2	497	10
0163597L24	0163597L618	0163597LM1	0163597LM2	597	10
0163697L24	0163697L618	0163697LM1	0163697LM2	697	10
0163797L24	0163797L618	0163797LM1	0163797LM2	797	10
0163897L24	0163897L618	0163897LM1	0163897LM2	897	5
0163997L24	0163997L618	0163997LM1	0163997LM2	997	5
01631197L24	01631197L618	01631197LM1	01631197LM2	1197	5
-	-	01633000LM1	01633000LM2	3000	15 *

*Available only in M1 and M2 finishes. Three metre profiles are delivered according to the units of the original packaging and cannot be sold separately. / Disponible solo en los acabados M1 y M2. Las barras de tres metros se sirven según las cantidades del embalaje original y no se pueden servir por separado.



0168 **COMO** ZAMAK Designer: Viefe Studio

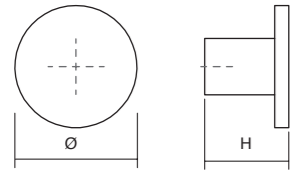

Z01	Z03	Z06	Z07	Z11	Z23	Z26	Z28	ZM1	ZM2	Ø	H	↓	☐
Polished chrome	Polished black nickel	Polished copper	Polished brass	Matt chrome	Brushed black nickel	Brushed copper	Brushed gold	Matt white	Matt black				
Cromo brillo	Níquel negro brillo	Cobre brillo	Latón brillo	Cromo mate	Níquel cepillado	Cobre cepillado	Oro cepillado	Blanco mate	Negro mate				
0168026Z01	0168026Z03	0168026Z06	0168026Z07	0168026Z11	0168026Z23	0168026Z26	0168026Z28	0168026ZM1	0168026ZM2	26	18	1	25
0168041Z01	0168041Z03	0168041Z06	0168041Z07	0168041Z11	0168041Z23	0168041Z26	0168041Z28	0168041ZM1	0168041ZM2	41	25	1	25

0497 **DIABOLO** ALUMINIUM Designer: Frank Person

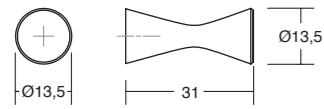

L24	L291	L30	L31	↓	☐
Stainless steel look Inox look	Brushed brass Latón cepillado	Brushed black Negro cepillado	Brushed grey Gris cepillado		
0497014L24	0497014L291	0497014L30	0497014L31	1	25

0499 **ROUND** ALUMINIUM Designer: Balutto Associati

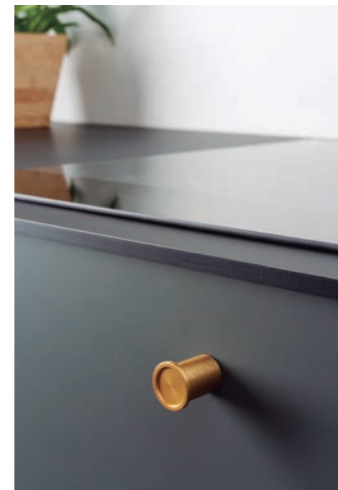
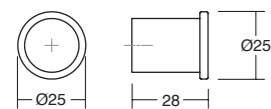

L24	L291	L30	↓	☐
Stainless steel look Inox look	Brushed brass Latón cepillado	Brushed black Negro cepillado		
0499025L24	0499025L291	0499025L30	1	25

0518 **WAY** ALUMINIUM Designer: Viefe Studio

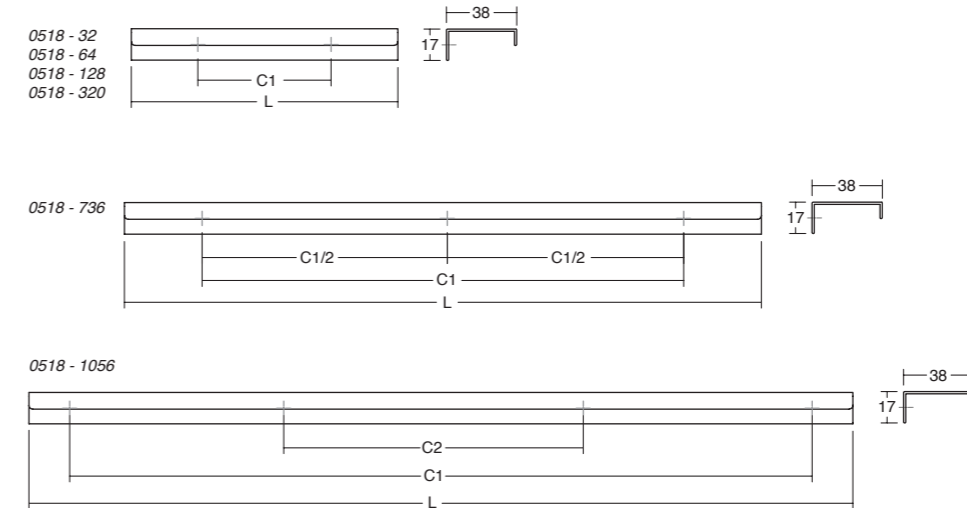

L04	L09	L24	L29	LM1	C1	C1/2	C2	L	↓	☐
Anodized matt Anodizado mate	Matt black Negro mate	Stainless steel look Inox look	Brushed dark brass Latón oscuro cepillado	Matt White Blanco mate						
0518032L04	0518032L09	0518032L24	0518032L29	0518032LM1	32	-	-	50	2	25
0518064L04	0518064L09	0518064L24	0518064L29	0518064LM1	64	-	-	100	2	25
0518128L04	0518128L09	0518128L24	0518128L29	0518128LM1	128	-	-	200	2	25
0518320L04	0518320L09	0518320L24	0518320L29	0518320LM1	320	-	-	400	2	25
0518736L04	0518736L09	0518736L24	0518736L29	0518736LM1	736	368	-	800	3	25
05181056L04	05181056L09	05181056L24	05181056L29	05181056LM1	1056	-	352	1100	4	15

0489 **BOL** ZAMAK / WOOD Designer: Balutto Associati

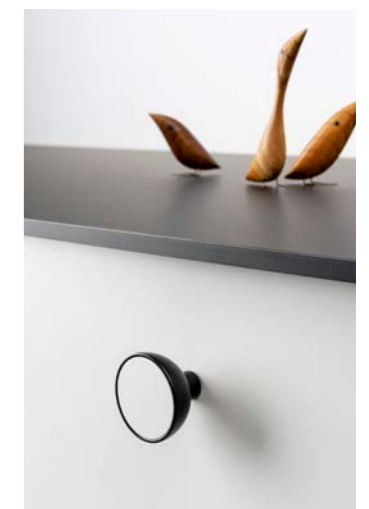
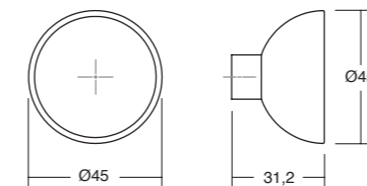

NM222 (ZM2+W22)	NM223 (ZM2+W23)	NM2M1 (ZM2+WM1)	↓	☐
Matt black + Sapelli Negro mate + Sapelli	Matt black + Beech Negro mate + Haya	Matt black + Matt white lacquered Negro mate + Lacado blanco mate		
0489045NM222	0489045NM223	0489045NM2M1	1	25

0511 **RAIL** ALUMINIUM Designer: Teruel & Paré

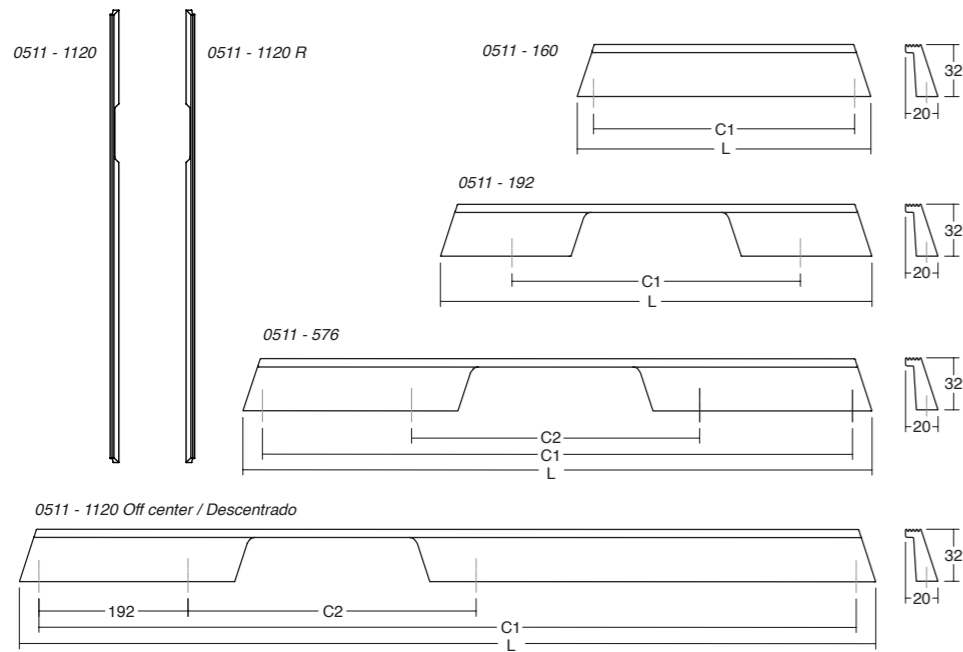

L24	L30	L618	C1	C2	L	↓	☐
Stainless steel look Inox look	Brushed black Negro cepillado	Brushed brass cava Latón cava cepillado					
0511160L24	0511160L30	0511160L618	160	-	180	2	25
0511192L24	0511192L30	0511192L618	192	-	280	2	25
0511576L24	0511576L30	0511576L618	576	192	600	4	15
05111120L24*	05111120L30*	05111120L618*	1120	192	1150	4	15 Off-center / Descentrado
05111120L24R*	05111120L30R*	05111120L618R*	1120	192	1150	4	15 Off-center / Descentrado

* The two 1150mm are symmetrical and one is left and the other right / Los dos de 1150mm son simétricos y uno es izquierda y el otro derecha

0507 **OBLONG** LEATHER / ZAMAK Designer: Frank Person

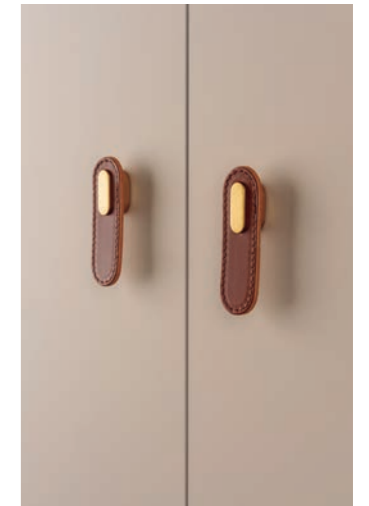
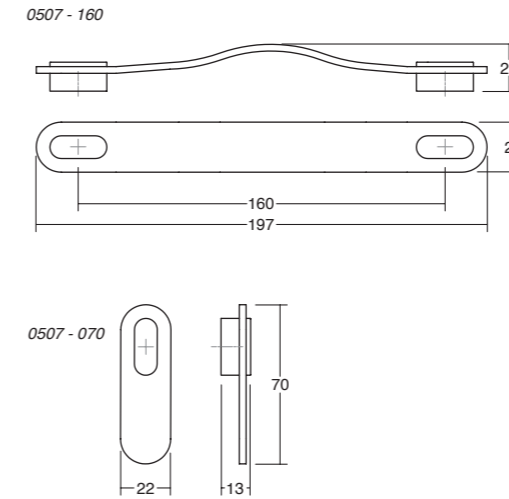

	P26 Beige / Beige	P36 Brown / Marrón	P99 Black / Negro	↓	☐
Z01 Polished chrome/ Cromo brillo	0507070P2601	0507070P3601	0507070P9901	1	25
Z01 Polished chrome/ Cromo brillo	0507160P2601	0507160P3601	0507160P9901	2	25
Z28 Brushed gold / Oro cepillado	0507070P2628	0507070P3628	0507070P9928	1	25
Z28 Brushed gold / Oro cepillado	0507160P2628	0507160P3628	0507160P9928	2	25
Z31 Brushed grey / Gris cepillado	0507070P2631	0507070P3631	0507070P9931	1	25
Z31 Brushed grey / Gris cepillado	0507160P2631	0507160P3631	0507160P9931	2	25
ZM1 Matt white / Blanco mate	0507070P26M1	-	-	1	25
ZM1 Matt white / Blanco mate	0507160P26M1	-	-	2	25
ZM2 Matt black / Negro mate	0507070P26M2	0507070P36M2	0507070P99M2	1	25
ZM2 Matt black / Negro mate	0507160P26M2	0507160P36M2	0507160P99M2	2	25

0056 **U** ZAMAK Designer: Viefe Studio

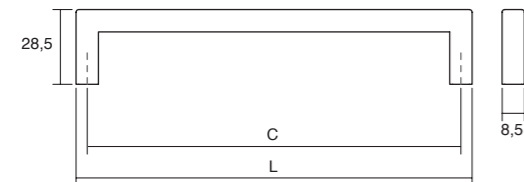

Z01	Z11	Z23	Z26	Z27	Z31	ZM1	ZM2	C	L	↓	☐
Polished chrome Cromo brillo	Matt chrome Cromo mate	Brushed nickel Níquel cepillado	Brushed copper Cobre cepillado	Brushed brass Latón cepillado	Brushed grey Gris cepillado	Matt white Blanco mate	Matt black Negro mate				
0056128Z01	0056128Z11	0056128Z23	0056128Z26	0056128Z27	0056128Z31	0056128ZM1	0056128ZM2	128	136,5	2	25
0056160Z01	0056160Z11	0056160Z23	0056160Z26	0056160Z27	0056160Z31	0056160ZM1	0056160ZM2	160	168,5	2	25
0056192Z01	0056192Z11	0056192Z23	0056192Z26	0056192Z27	0056192Z31	0056192ZM1	0056192ZM2	192	200,5	2	25
0056320Z01	0056320Z11	0056320Z23	0056320Z26	0056320Z27	0056320Z31	0056320ZM1	0056320ZM2	320	328,5	2	25
0056492Z01	0056492Z11	0056492Z23	0056492Z26	0056492Z27	0056492Z31	0056492ZM1	0056492ZM2	492	500,5	2	25

0241 **ROMA** ZAMAK Designer: 2J Design

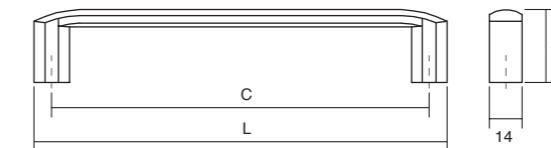

Z01	Z23	Z28	ZM2	C	L	↓	☐
Polished chrome Cromo brillo	Brushed nickel Níquel cepillado	Brushed gold Oro cepillado	Matt black Negro mate				
0241160Z01	0241160Z23	0241160Z28	0241160ZM2	160	175	2	25
0241192Z01	0241192Z23	0241192Z28	0241192ZM2	192	207	2	25
0241320Z01	0241320Z23	0241320Z28	0241320ZM2	320	335	2	25

0494 **LAND** ZAMAK Designer: Héctor Diego

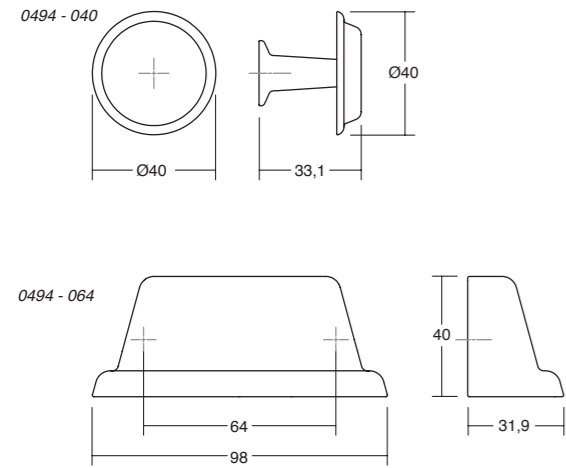

Z28	Z610	Z614	ZM2		
Brushed gold Oro cepillado	Pewter Peltre	Antique brass Latón antiguo	Matt black Negro mate	↓	📦
0494040Z28	0494040Z610	0494040Z614	0494040ZM2	1	25
0494064Z28	0494064Z610	0494064Z614	0494064ZM2	2	25

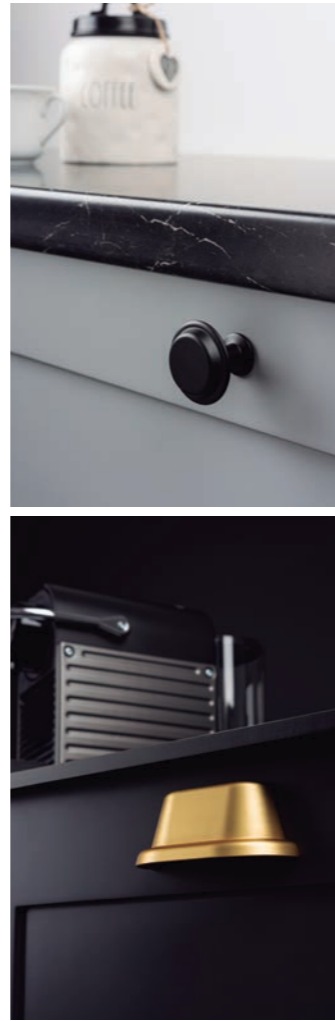

0506 **FIRM** ZAMAK Designer: Frank Person

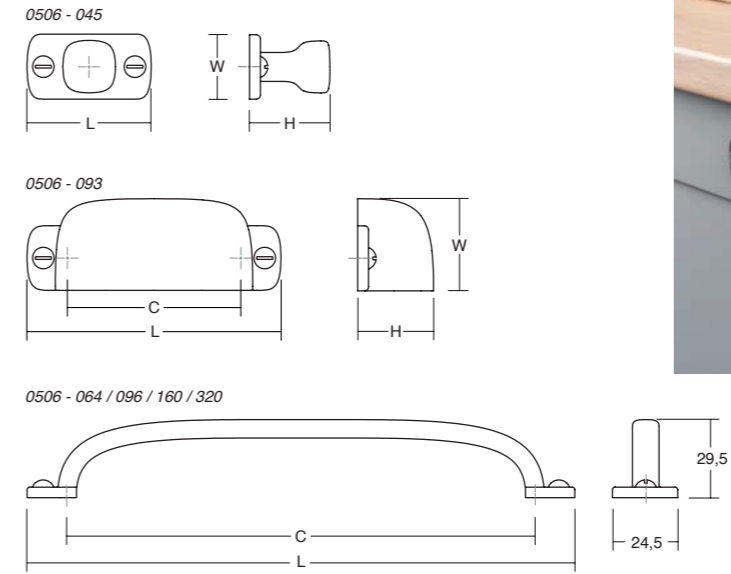

ZM22	C	L	W	H	↓	📦
Textured black Negro texturizado						
NEW! 0506045ZM22	-	45,8	24	29,9	1	25
0506064ZM22	64	93,8	24,5	29,5	2	25
NEW! 0506093ZM22	64	93,8	34	28	2	25
0506096ZM22	96	125,8	24,5	29,5	2	25
0506160ZM22	160	189,8	24,5	29,6	2	25
0506320ZM22	320	349,8	24,5	29,6	2	25



0446 **ESTE** ZAMAK Designer: Balutto Associati

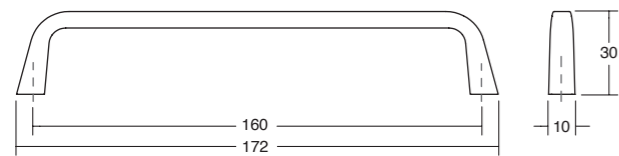

Z01	Z11	Z23	Z26	Z28	Z617	ZM2		
Polished chrome Cromo brillo	Matt chrome Cromo mate	Brushed nickel Níquel cepillado	Brushed copper Cobre cepillado	Brushed gold Oro cepillado	Graphite grey Gris grafito	Matt black Negro mate	↓	📦
0446160Z01	0446160Z11	0446160Z23	0446160Z26	0446160Z28	0446160Z617	0446160ZM2	2	25



0459 **LINES** ZAMAK Designer: Teruel & Paré

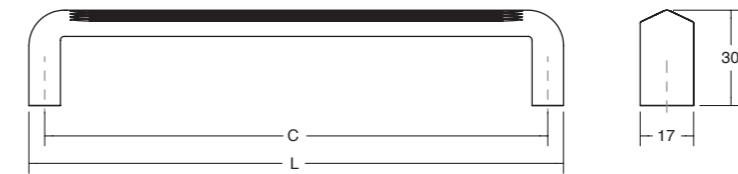

Z23	Z28	Z32	ZM2	C	L	↓	📦
Brushed Níquel Níquel cepillado	Brushed gold Oro cepillado	Brushed mole grey Gris topo cepillado	Matt black Negro mate				
0459160Z23	0459160Z28	0459160Z32	0459160ZM2	160	170	2	25
0459320Z23	0459320Z28	0459320Z32	0459320ZM2	320	330	2	25

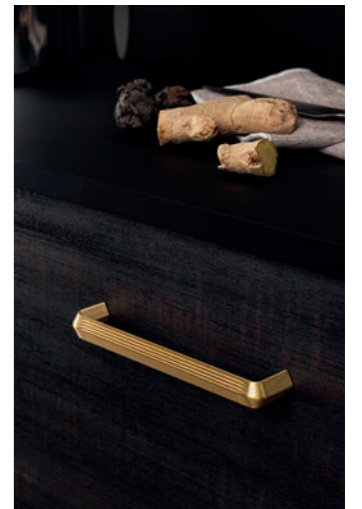

0516 **PENDANT** ZAMAK Designer: Frank Person

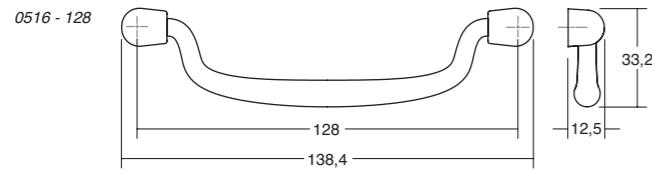
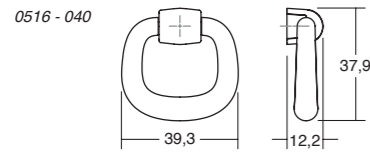

Z610	Z614	ZM2	↓	☐
Pewter	Antique brass	Matt black		
Peltre	Latón antiguo	Negro mate		
0516040Z610	0516040Z614	0516040ZM2	1	25
0516128Z610	0516128Z614	0516128ZM2	2	25

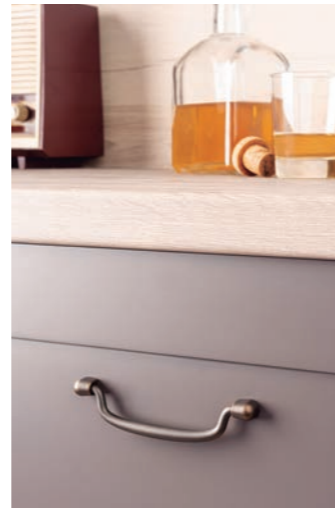

0486 **GRAF BIG** ALUMINIUM Designer: Viefe Studio

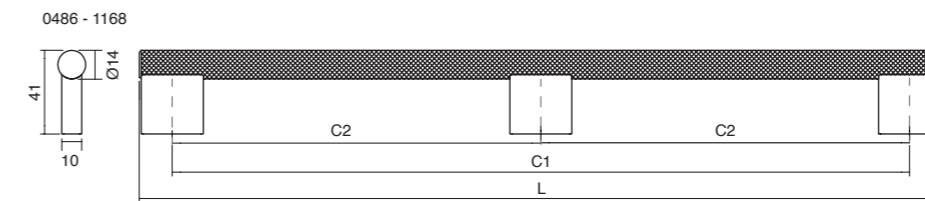
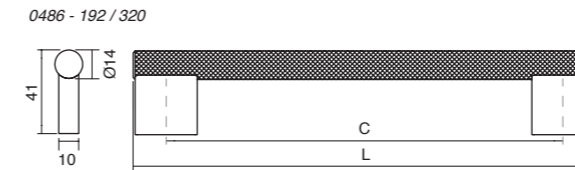
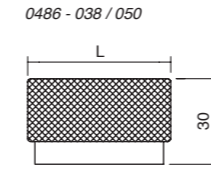

L24	L291	L30	C1	C2	L	↓	☐
Stainless steel look	Brushed brass	Brushed black					
Inox look	Latón cepillado	Negro cepillado					
0486038L24	0486038L291	0486038L30	-	-	Ø38	1	25
0486050L24	0486050L291	0486050L30	-	-	Ø50	1	25
0486192L24	0486192L291	0486192L30	192	-	224	2	25
0486320L24	0486320L291	0486320L30	320	-	352	2	25
04861168L24	04861168L291	04861168L30	1168	584	1200	3	10

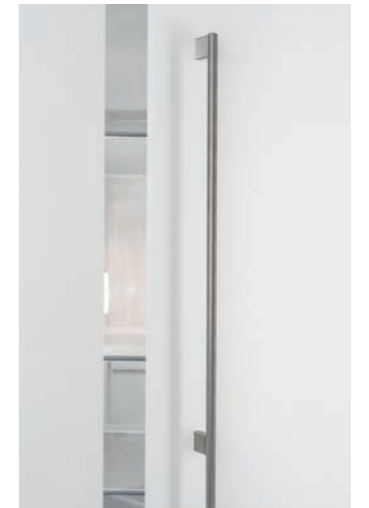
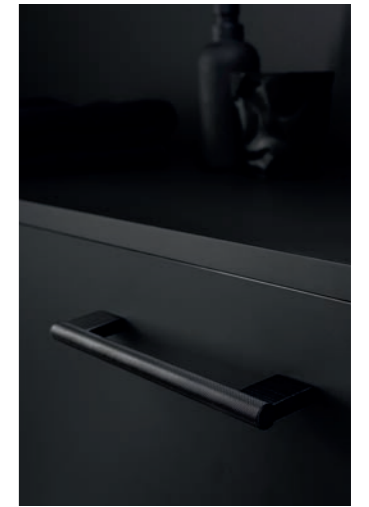
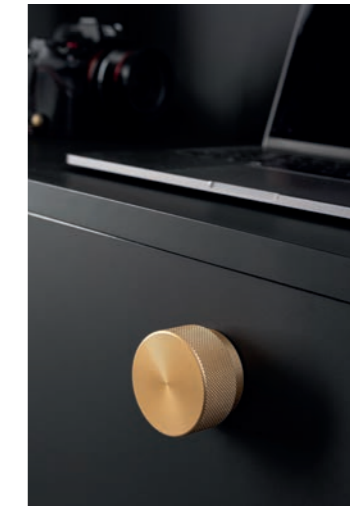

0094 **HIDE** ZAMAK Designer: Viefe Studio

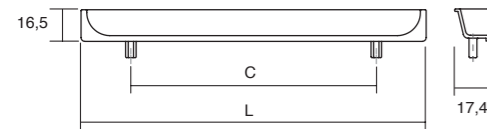

Z01	Z23	Z28	ZP1	ZM1	ZM2	C	L	↓	☐
Polished chrome	Brushed nickel	Brushed gold	Chrome look	Matt white	Matt black				
Cromo brillo	Níquel cepillado	Oro cepillado	Cromo look	Blanco mate	Negro mate				
0094090Z01	0094090Z23	0094090Z28	-	0094090ZM1	0094090ZM2	64	90	2	25
0094180Z01	0094180Z23	0094180Z28	-	0094180ZM1	0094180ZM2	128	180	2	25
-	-	-	0094200ZP1	-	-	128	200	2	25

0430 **GRAF MINI** ALUMINIUM Designer: Viefe Studio

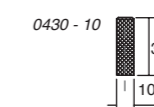
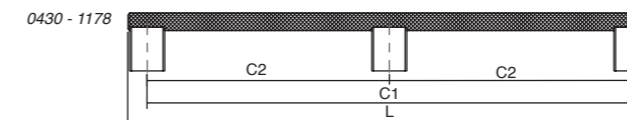
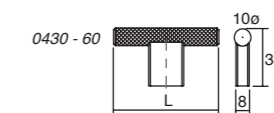
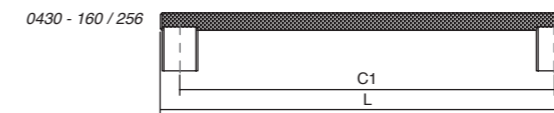

L24	L291	L30	C1	C2	L	↓	☐
Stainless steel look	Brushed brass	Brushed black					
Inox look	Latón cepillado	Negro cepillado					
0430010L24	0430010L291	0430010L30	-	-	10	1	25
0430060L24	0430060L291	0430060L30	-	-	60	1	25
0430160L24	0430160L291	0430160L30	160	-	182	2	25
0430256L24	0430256L291	0430256L30	256	-	278	2	25
04301178L24	04301178L291	04301178L30	1178	589	1200	3	10

Includes non-twisting tip / Incluye punta anti-giro



0109 **GRAF** ALUMINIUM Designer: Viefe Studio

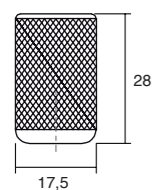

L01	L04	L24	L27	L291	LM2	
Polished chrome	Anodized matt	Stain. steel look	Brushed brass	Brushed brass	Matt black	↓
Cromo brillo	Anodizado mate	Inox look	Latón cepillado	Latón cepillado	Negro mate	↓
0109017L01	0109017L04	0109017L24	0109017L27	0109017L291	0109017LM2	1 25

0447 **BELLA** ZAMAK Designer: Balutto Associati

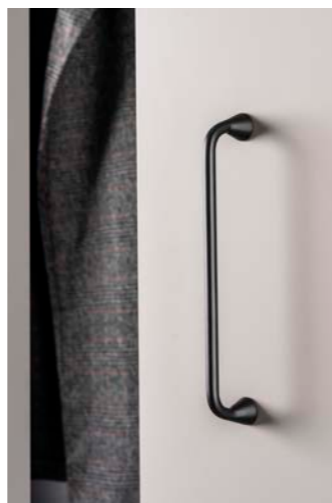
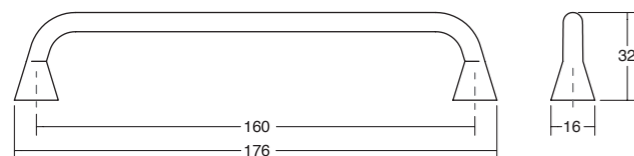

Z26	Z28	Z617	ZM2	
Brushed copper	Brushed gold	Graphite grey	Matt black	↓
Cobre cepillado	Oro cepillado	Gris grafito	Negro mate	↓
0447160Z26	0447160Z28	0447160Z617	0447160ZM2	2 25

0451 **FELTRE** ZAMAK Designer: Balutto Associati

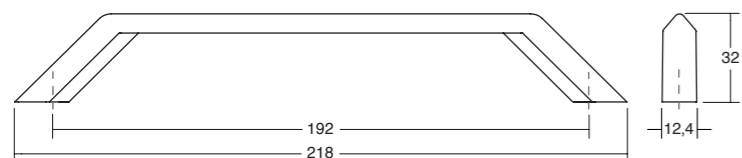

Z23	Z617	ZM2	
Brushed nickel	Graphite grey	Matt black	↓
Níquel cepillado	Gris grafito	Negro mate	↓
0451192Z23	0451192Z617	0451192ZM2	2 25

0449 **HEXXA** ALUMINIUM/ZAMAK Designer: Alexis Vivet

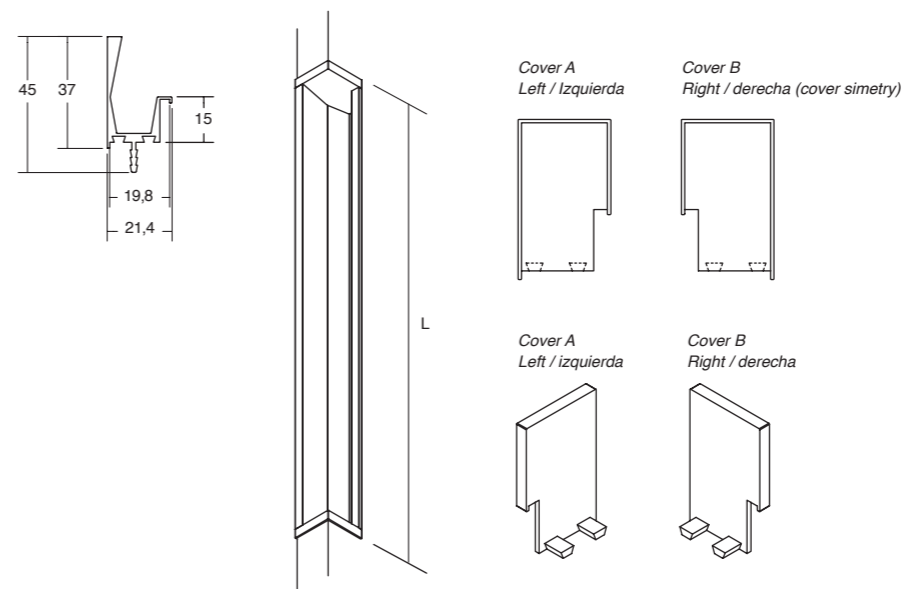

LM1	LM2	LM23	LM41	L	
Matt white	Matt black	Metallic grey	Metallic brown		↓
Blanco mate	Negro mate	Gris metal	Marrón metal		↓
0449200LM1	0449200LM2	0449200LM23	0449200LM41	200	25 ALUMINIUM
0449350LM1	0449350LM2	0449350LM23	0449350LM41	350	25 ALUMINIUM
04491100LM1	04491100LM2	04491100LM23	04491100LM41	1100	15 ALUMINIUM
04493000LM1	04493000LM2	04493000LM23	04493000LM41	3000	10* ALUMINIUM
0449035ZM1A	0449035ZM2A	0449035ZM23A	0449035ZM41A	-	25 ZAMAK
0449035ZM1B	0449035ZM2B	0449035ZM23B	0449035ZM41B	-	25 ZAMAK

* Three metre profiles are delivered according to the units of the original packaging and cannot be sold separately.
Las barras de tres metros se sirven según las cantidades del embalaje original y no se pueden servir por separado.

0119 **WAVE** ZAMAK Designer: Viefe Studio

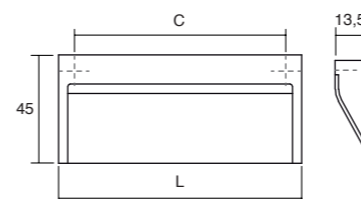

Z01	Z23	ZM2	C	L	
Polished chrome	Brushed nickel	Matt black			↓
Cromo brillo	Níquel cepillado	Negro mate			↓
0119032Z01	0119032Z23	0119032ZM2	32	45	2 25
0119160Z01	0119160Z23	0119160ZM2	160	173	2 25

0105 NEST

ZAMAK

Designer: Viefe Studio

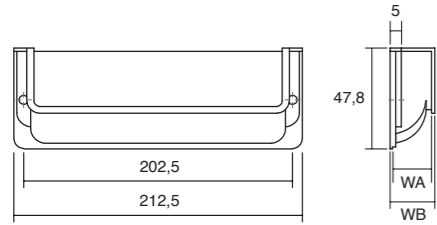

Z01	Z01M1	Z23	Z23M1	ZM2	WA	WB	↓	☐	Door
Polished chrome <i>Cromo brillo</i>	Polished chrome+White <i>Cromo brillo+ Blanco</i>	Brushed nickel <i>Níquel cepillado</i>	Brushed nickel+White <i>Níquel cepillado+Blanco</i>	Matt black <i>Negro mate</i>					
0105186Z01ST	0105186Z01M1	0105186Z23ST	0105186Z23M1	0105186ZM2ST	18,6	21,3	2	25	19
-	-	0105206Z23ST	-	-	20,6	23,3	2	25	20,5

0073 TAP

ZAMAK

Designer: Viefe Studio

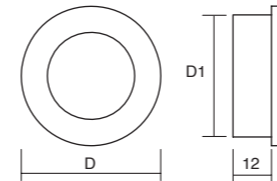

ZP1	ZM2	D	D1	☐
Chrome look <i>Cromo look</i>	Matt black <i>Negro mate</i>			
0073040ZP1	0073040ZM2	40	35,5	25
0073060ZP1	0073060ZM2	60	55,3	25

0235 CLOS

ZAMAK

Designer: Viefe Studio

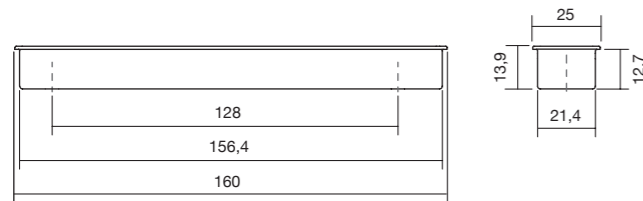

ZM1	ZM2	Z01	Z23	↓	☐
Matt white <i>Blanco mate</i>	Matt black <i>Negro mate</i>	Polished chrome <i>Cromo brillo</i>	Brushed nickel <i>Níquel cepillado</i>		
0235128ZM1	0235128ZM2	0235128Z01	0235128Z23	2	25

0301 SENSE MINI

ALUMINIUM

Designer: Viefe Studio

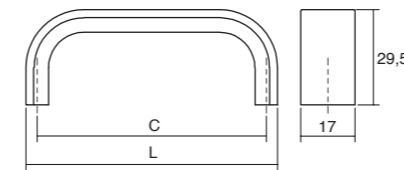

L01	L09	L24	L29	C	L	↓	☐
Polished chrome <i>Cobre brillo</i>	Matt black <i>Negro mate</i>	Stainless steel look <i>inox look</i>	Brushed dark brass <i>Latón oscuro cepillado</i>				
0301096L01	0301096L09	0301096L24	0301096L29	96	103	2	25
0301160L01	0301160L09	0301160L24	0301160L29	160	167	2	25
0301256L01	0301256L09	0301256L24	0301256L29	256	263	2	25

0366 CUBIC

ZAMAK

Designer: Viefe Studio

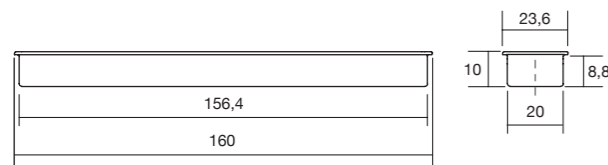

ZM1	ZM2	☐
Matt white <i>Blanco mate</i>	Matt black <i>Negro mate</i>	
0366160ZM1	0366160ZM2	25

0195 SENSE

ALUMINIUM

Designer: Viefe Studio

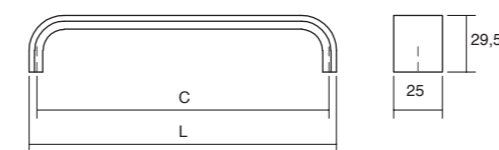

L01	L24	L30	C	L	↓	☐
Polished chrome <i>Cromo brillo</i>	Stainless steel look <i>Inox look</i>	Brushed black <i>Negro cepillado</i>				
0195128L01	0195128L24	0195128L30	128	135	2	25
0195192L01	0195192L24	0195192L30	192	199	2	25
0195320L01	0195320L24	0195320L30	320	327	2	25
0195480L01	0195480L24	0195480L30	480	487	2	25

0162 **KADO** ZAMAK Designer: Viefe Studio

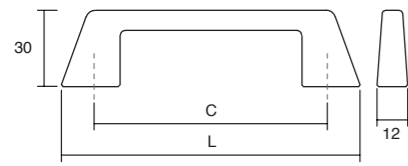

Z01 Polished chrome Cromo brillo	Z23 Brushed nickel Níquel cepillado	C	L	↓	☐
0162160Z01	0162160Z23	160	186	2	25
0162320Z01	0162320Z23	320	346	2	25



0077 **ANGLE** ALUMINIUM Designer: Viefe Studio

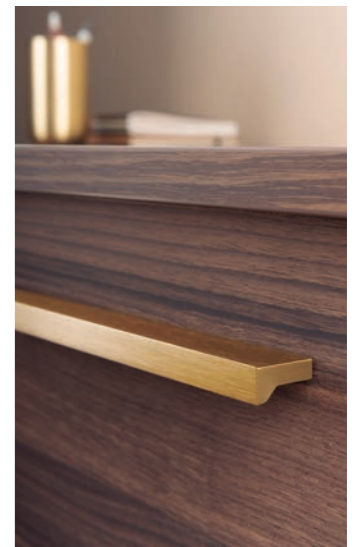
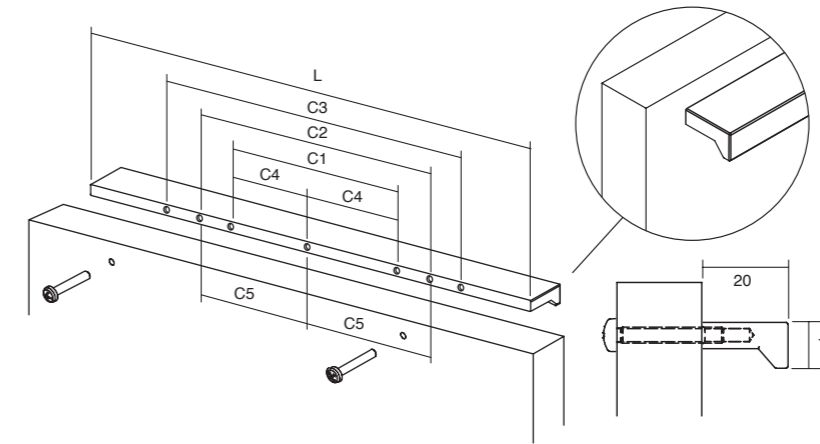

0373 **NICK** ZAMAK Designer: Alexis Vivet

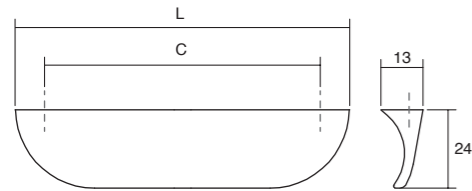

Z01 Polished chrome Cromo brillo	Z23 Brushed nickel Níquel cepillado	Z26 Brushed copper Cobre cepillado	Z27 Brushed brass Latón cepillado	C	L	↓	☐
0373032Z01	0373032Z23	0373032Z26	0373032Z27	32	50	2	25
0373160Z01	0373160Z23	0373160Z26	0373160Z27	160	178	2	25



L01 Polish. chrome Cromo brillo	L04 Anodized matt Anodizado mate	L24 Stai. steel look Inox look	L29 Brus. dark brass Ltn osc. cepillado	LM1 Matt White Blanco mate	LM2 Matt black Negro mate	LM23 Metallic grey Gris metal	LM41 Metallic brown Marrón metal	C1	C2	C3	C4	C5	L	↓	☐
-	0077032L04	-	-	-	-	-	-	32	-	-	-	-	45	2	25
-	0077064L04	-	-	-	-	-	-	64	-	-	-	-	90	2	25
0077064L01	-	0077064L24	0077064L29	0077064LM1	0077064LM2	0077064LM23	0077064LM41	64	-	-	-	-	100	2	25
-	0077096L04	-	-	0077128LM1	0077128LM2	0077128LM23	0077128LM41	128	160	-	-	-	200	4	25
-	0077128L04	-	-	-	-	-	-	96	-	-	-	-	120	2	25
0077128L01	-	0077128L24	0077128L29	-	-	-	-	128	-	-	-	-	150	2	25
-	0077160L04	-	-	-	-	-	-	96	128	160	-	-	200	6	25
-	0077192L04	-	-	-	-	-	-	160	-	-	-	-	190	2	25
0077192L01	-	0077192L24	0077192L29	0077192LM1	0077192LM2	0077192LM23	0077192LM41	192	-	-	-	-	300	2	25
-	0077256L04	-	-	0077256LM1	0077256LM2	0077256LM23	0077256LM41	256	-	-	-	-	400	2	25
0077256L01	-	0077256L24	0077256L29	-	-	-	-	256	-	-	-	-	300	2	25
-	-	-	-	0077416LM1	0077416LM2	0077416LM23	0077416LM41	256	320	-	-	-	400	4	25
0077416L01	-	0077416L24	0077416L29	-	-	-	-	416	-	-	-	-	500	2	25
-	-	-	-	0077480LM1	0077480LM2	0077480LM23	0077480LM41	320	416	-	-	-	500	4	25
0077512L01	-	0077512L24	0077512L29	-	-	-	-	480	-	-	-	-	600	2	25
0077640L01	-	0077640L24	0077640L29	0077640LM1	0077640LM2	0077640LM23	0077640LM41	480	512	-	-	256	600	5	25
-	-	-	-	00771440LM1	00771440LM2	00771440LM23	00771440LM41	640	-	-	320	-	900	3	25
-	-	-	-	-	-	-	-	480	1440	-	-	-	1480	4	10

0341 **ASI** ALUMINIUM Designer: Oriol Barri

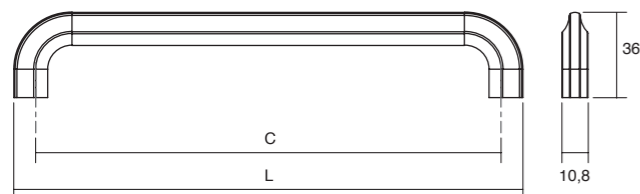

LM2 Matt black Negro mate	C	L	↓	☐
0341128LM2	128	146	2	25
0341192LM2	192	210	2	25
0341320LM2	320	338	2	25



0206 **ARCH** ZAMAK Designer: 2J Design

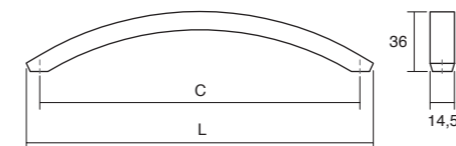

Z01 Polished chrome Cromo brillo	Z23 Brushed nickel Níquel cepillado	C	L	↓	☐
0206192Z01	0206192Z23	192	208,5	2	25
0206320Z01	0206320Z23	320	338,5	2	25



0452 **BRAVE** ALUMINIUM Designer: Viefe Studio

LM1	LM2	LM23	LM41	C1	C2	L	↓	⊞
Matt white Blanco mate	Matt black Negro mate	Metallic grey Gris metal	Metallic brown Marrón metal					
0452128FM1	0452128FM2	0452128FM23	0452128FM41	128	-	160	2	25
0452192FM1	0452192FM2	0452192FM23	0452192FM41	192	-	240	2	25
0452320FM1	0452320FM2	0452320FM23	0452320FM41	320	-	400	2	25
0452480FM1	0452480FM2	0452480FM23	0452480FM41	192	480	600	4	25
0452992FM1	0452992FM2	0452992FM23	0452992FM41	192	992	1040	4	15
04521120FM1	04521120FM2	04521120FM23	04521120FM41	192	1120	1150	4	15

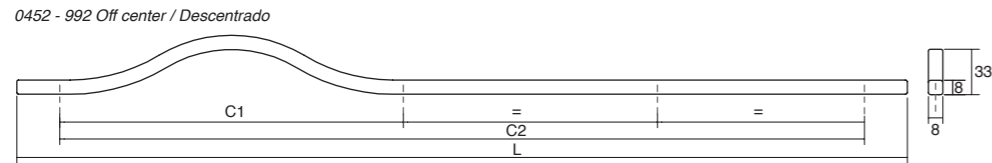
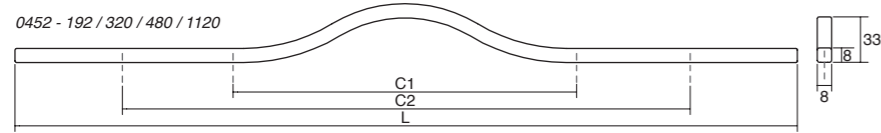
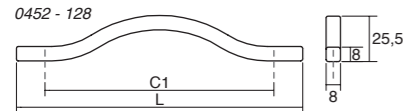

0444 **PEAK** ALUMINIUM Designer: Viefe Studio

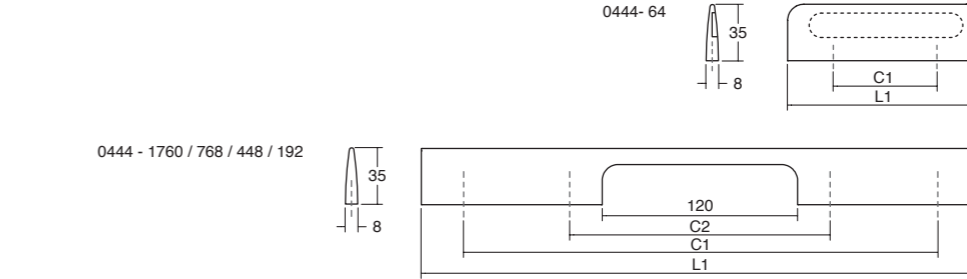

0444-1120 Off center / Descentrado

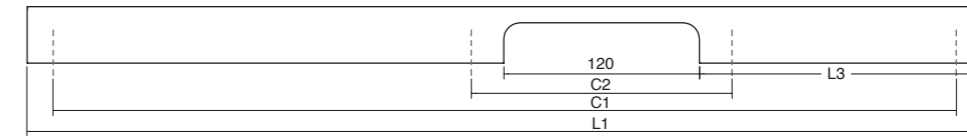

L24	L30	LM1	LM23	LM41	C1	C2	L1	L3	↓	⊞
Stain. steel look Inox look	Brushed black Negro cepillado	Matt white Blanco mate	Metallic grey Gris metal	Metallic brown Marrón metal						
0444064L24	0444064L30	0444064LM1	0444064LM23	0444064LM41	64	-	120	-	2	25
0444192L24	0444192L30	0444192LM1	0444192LM23	0444192LM41	192	160	250	-	4	25
0444448L24	0444448L30	0444448LM1	0444448LM23	0444448LM41	448	160	500	-	4	25
0444768L24	0444768L30	0444768LM1	0444768LM23	0444768LM41	768	160	800	-	4	15
04441120L24	04441120L30	04441120LM1	04441120LM23	04441120LM41	1120	160	1150	190	4	15
04441760L24	04441760L30	04441760LM1	04441760LM23	04441760LM41	1760	160	1800	-	4	10



0322 **CUTT** ALUMINIUM Designer: Alexis Vivet

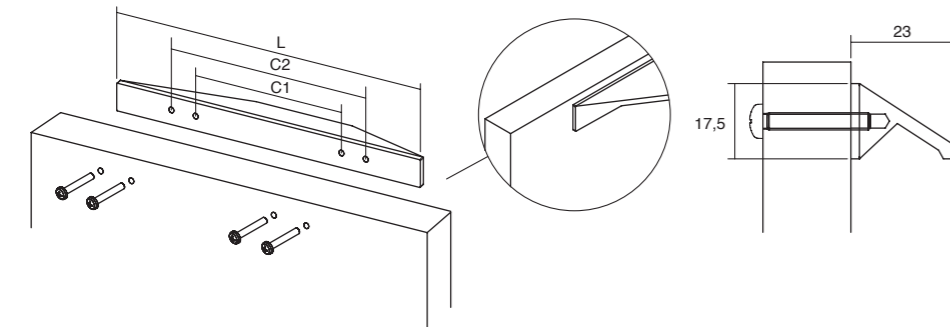

L01	L09	L24	C1	C2	L	↓	⊞
Polished chrome Cromo brillo	Matt black Negro mate	Stainless steel look Inox look					
0322200L01	0322200L09	0322200L24	96	128	200	4	25
0322400L01	0322400L09	0322400L24	192	320	400	4	25
0322600L01	0322600L09	0322600L24	320	480	600	4	25
-	03221000L09	03221000L24	320	896	1000	4	15
-	03221500L09	03221500L24	480	1376	1500	4	10



0375 **VANN** ALUMINIUM Designer: Alexis Vivet

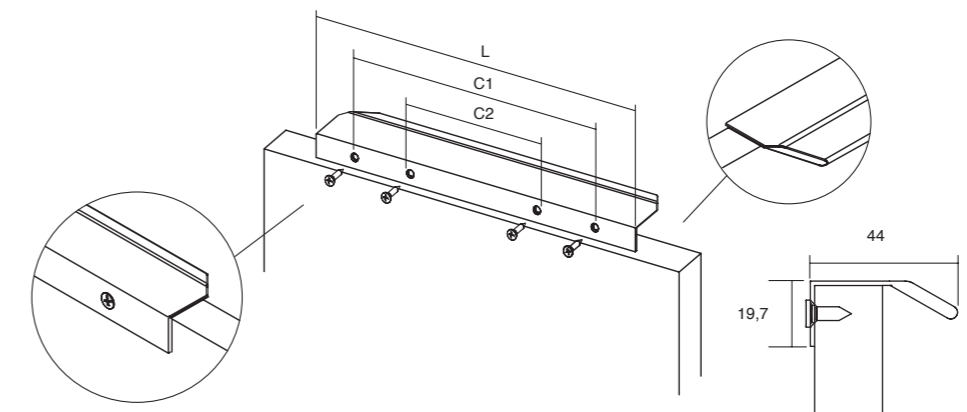

L02	L04	L09	L24	L29	C1	C2	L	↓	⊞
Anodized bright Anodizado brillo	Anodized matt Anodizado mate	Matt black Negro mate	Stain steel look Inox look	Brushed dark brass Latón oscuro cepill.					
0375064L02	0375064L04	0375064L09	0375064L24	0375064L29	64	-	100	2	25
0375128L02	0375128L04	0375128L09	0375128L24	0375128L29	128	-	200	2	25
0375256L02	0375256L04	0375256L09	0375256L24	0375256L29	256	-	350	2	25
-	03751120L04	03751120L09	03751120L24	03751120L29	1120	384	1200	4	15

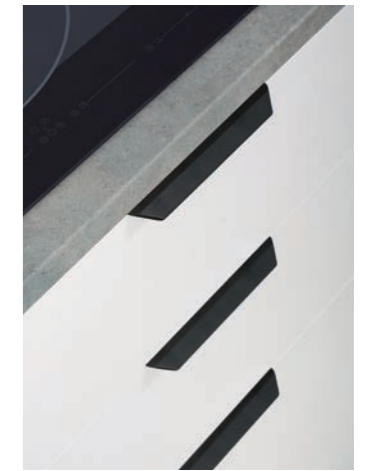

0372 **ONA** ALUMINIUM Designer: Teruel Paré

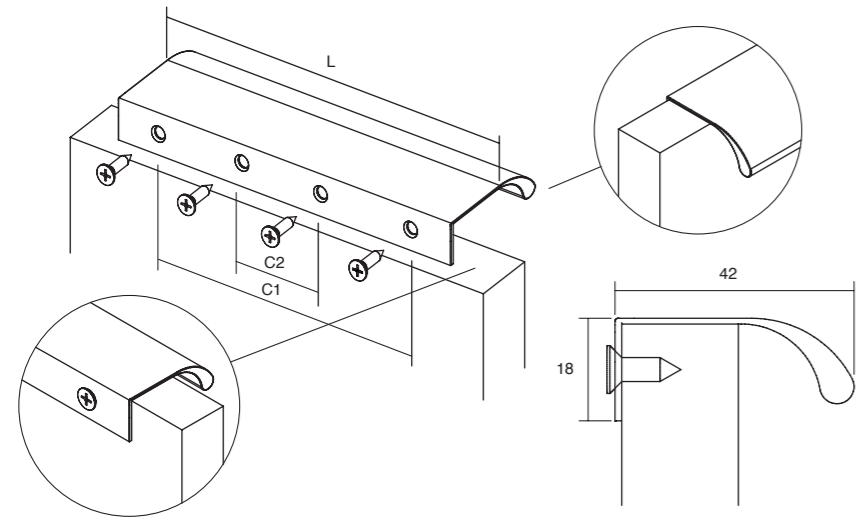

L24	L29	L30	L31	LM1	LM23	LM41	C1	C2	L	↓	☐
Stainless steel look Inox look	Brushed dark brass Latón cepillado oscuro	Brushed black Negro cepillado	Brushed grey Gris cepillado	Matt white Blanco mate	Metallic grey Gris metal	Metallic brown Marrón metal					
0372032L24	0372032L29	0372032L30	0372032L31	0372032LM1	0372032LM23	0372032LM41	32	-	50	2	25
0372128L24	0372128L29	0372128L30	0372128L31	0372128LM1	0372128LM23	0372128LM41	128	-	200	2	25
0372256L24	0372256L29	0372256L30	0372256L31	0372256LM1	0372256LM23	0372256LM41	256	-	350	2	25
0372544L24	0372544L29	0372544L30	0372544L31	0372544LM1	0372544LM23	0372544LM41	544	-	600	3	25
03721056L24	03721056L29	03721056L30	03721056L31	03721056LM1	03721056LM23	03721056LM41	1056	416	1100	4	15
03721440L24	03721440L29	03721440L30	03721440L31	03721440LM1	03721440LM23	03721440LM41	1440	480	1500	4	10

0053 **DINO** ZAMAK Designer: Viefe Studio

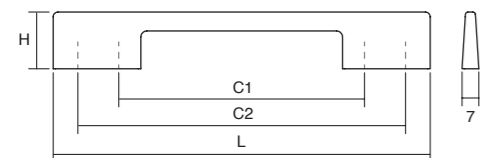

Z01	Z23	ZM1	ZM2	ZP4	C1	C2	L	H	↓	☐
Polished chrome Cromo brillo	Brushed nickel Níquel cepillado	Matt white Blanco mate	Matt black Negro mate	Aluminium look Aluminio look						
0053096Z01	0053096Z23	0053096ZM1	0053096ZM2	0053096ZP4	96	128	156	24	4	25
0053192Z01	0053192Z23	0053192ZM1	0053192ZM2	0053192ZP4	160	192	221	28	4	25
0053320Z01	0053320Z23	0053320ZM1	0053320ZM2	0053320ZP4	288	320	349	28	4	25

0117 **CURVE** ALUMINIUM Designer: Viefe Studio

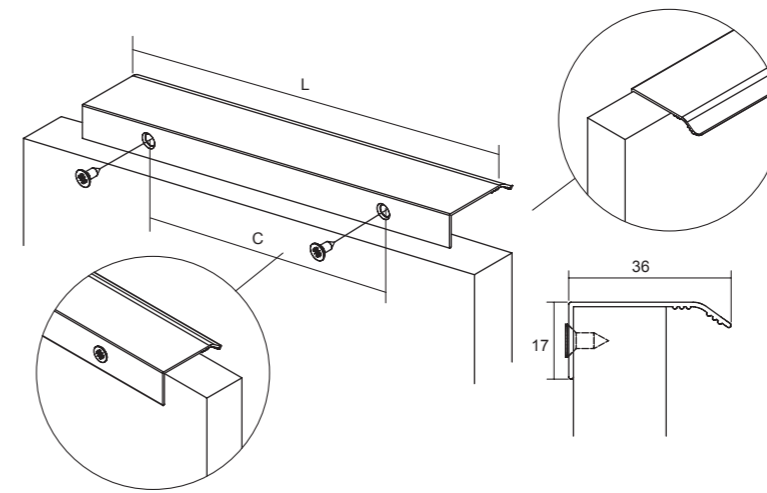

L04	L24	L31	LM1	LM2	C	L	↓	☐
Anodized matt Anodizado mate	Stainless steel look Inox look	Brushed grey Gris cepillado	Matt white Blanco mate	Matt black Negro mate				
0117032L04	0117032L24	0117032L31	0117032LM1	0117032LM2	32	45	2	25
-	0117064L24	-	-	-	64	100	2	25
0117128L04	0117128L24	0117128L31	0117128LM1	0117128LM2	128	200	2	25
-	0117192L24	-	-	-	192	300	2	25
-	0117320L24	-	-	-	320	400	3	25
-	0117416L24	-	-	-	416	500	3	25

0139 / 0140 **LINEAR** ALUMINIUM Designer: Viefe Studio

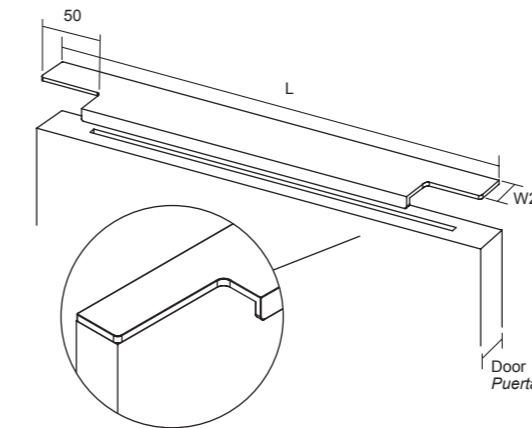

L24	L30	L	W	W2	Door Puerta	L24	L30	L	W	W2	Door Puerta
Stain. steel look Inox look	Brushed black Negro cepillado		(d19)			Stain. steel look Inox look	Brushed black Negro cepillado		(d20,5)		
0139147L24	0139147L30	147	37	19,8	15 19mm	0140147L24	0140147L30	147	38,5	21	15 20,5mm
0139197L24	0139197L30	197	37	19,8	15 19mm	0140197L24	0140197L30	197	38,5	21	15 20,5mm
0139247L24	0139247L30	247	37	19,8	15 19mm	0140247L24	0140247L30	247	38,5	21	15 20,5mm
0139297L24	0139297L30	297	37	19,8	15 19mm	0140297L24	0140297L30	297	38,5	21	15 20,5mm
0139347L24	0139347L30	347	37	19,8	15 19mm	0140347L24	0140347L30	347	38,5	21	15 20,5mm
0139397L24	0139397L30	397	37	19,8	15 19mm	0140397L24	0140397L30	397	38,5	21	15 20,5mm
0139447L24	0139447L30	447	37	19,8	10 19mm	0140447L24	0140447L30	447	38,5	21	10 20,5mm
0139497L24	0139497L30	497	37	19,8	10 19mm	0140497L24	0140497L30	497	38,5	21	10 20,5mm
0139597L24	0139597L30	597	37	19,8	10 19mm	0140597L24	0140597L30	597	38,5	21	10 20,5mm
0139697L24	0139697L30	697	37	19,8	10 19mm	0140697L24	0140697L30	697	38,5	21	10 20,5mm
0139797L24	0139797L30	797	37	19,8	10 19mm	0140797L24	0140797L30	797	38,5	21	10 20,5mm
0139897L24	0139897L30	897	37	19,8	5 19mm	0140897L24	0140897L30	897	38,5	21	5 20,5mm
0139997L24	0139997L30	997	37	19,8	5 19mm	0140997L24	0140997L30	997	38,5	21	5 20,5mm
01391197L24	01391197L30	1197	37	19,8	5 19mm	01401197L24	01401197L30	1197	38,5	21	5 20,5mm

0434 / 0435 / 0436 **VECTOR** ALUMINIUM Designer: Viefe Studio

L24	L30	L31	L	W1	W2	Door
S. steel look Inox look	Brushed black Negro cepillado	Brushed grey Gris cepillado				Puerta
0434147L24	0434147L30	0434147L31	147	41	19,8	15 19
0434197L24	0434197L30	0434197L31	197	41	19,8	15 19
0434247L24	0434247L30	0434247L31	247	41	19,8	15 19
0434297L24	0434297L30	0434297L31	297	41	19,8	15 19
0434347L24	0434347L30	0434347L31	347	41	19,8	15 19
0434397L24	0434397L30	0434397L31	397	41	19,8	15 19
0434447L24	0434447L30	0434447L31	447	41	19,8	10 19
0434497L24	0434497L30	0434497L31	497	41	19,8	10 19
0434597L24	0434597L30	0434597L31	597	41	19,8	10 19
0434697L24	0434697L30	0434697L31	697	41	19,8	10 19
0434797L24	0434797L30	0434797L31	797	41	19,8	10 19
0434897L24	0434897L30	0434897L31	897	41	19,8	5 19
0434997L24	0434997L30	0434997L31	997	41	19,8	5 19
04341197L24	04341197L30	04341197L31	1197	41	19,8	5 19

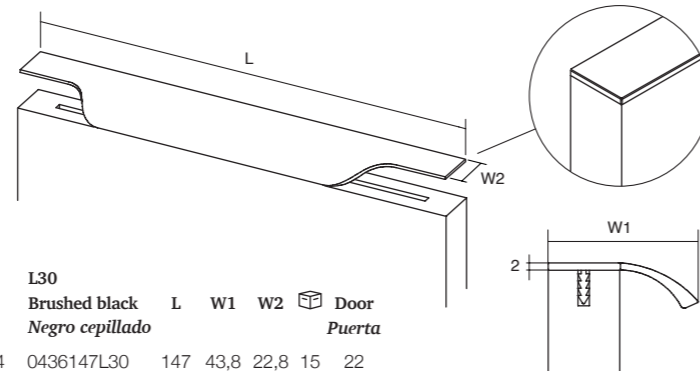

L24	L30	L	W1	W2	Door
S. steel look Inox look	Brushed black Negro cepillado				Puerta
0435147L24	0435147L30	147	43,8	21	15 20,5
0435197L24	0435197L30	197	43,8	21	15 20,5
0435247L24	0435247L30	247	43,8	21	15 20,5
0435297L24	0435297L30	297	43,8	21	15 20,5
0435347L24	0435347L30	347	43,8	21	15 20,5
0435397L24	0435397L30	397	43,8	21	15 20,5
0435447L24	0435447L30	447	43,8	21	10 20,5
0435497L24	0435497L30	497	43,8	21	10 20,5
0435597L24	0435597L30	597	43,8	21	10 20,5
0435697L24	0435697L30	697	43,8	21	10 20,5
0435797L24	0435797L30	797	43,8	21	10 20,5
0435897L24	0435897L30	897	43,8	21	5 20,5
0435997L24	0435997L30	997	43,8	21	5 20,5
04351197L24	04351197L30	1197	43,8	21	5 20,5

L24	L30	L	W1	W2	Door
S. steel look Inox look	Brushed black Negro cepillado				Puerta
0436147L24	0436147L30	147	43,8	22,8	15 22
0436197L24	0436197L30	197	43,8	22,8	15 22
0436247L24	0436247L30	247	43,8	22,8	15 22
0436297L24	0436297L30	297	43,8	22,8	15 22
0436347L24	0436347L30	347	43,8	22,8	15 22
0436397L24	0436397L30	397	43,8	22,8	15 22
0436447L24	0436447L30	447	43,8	22,8	10 22
0436497L24	0436497L30	497	43,8	22,8	10 22
0436597L24	0436597L30	597	43,8	22,8	10 22
0436697L24	0436697L30	697	43,8	22,8	10 22
0436797L24	0436797L30	797	43,8	22,8	10 22
0436897L24	0436897L30	897	43,8	22,8	5 22
0436997L24	0436997L30	997	43,8	22,8	5 22
04361197L24	04361197L30	1197	43,8	22,8	5 22

0250 / 0251 / 0253 **FORMA** ALUMINIUM Designer: 2J Design

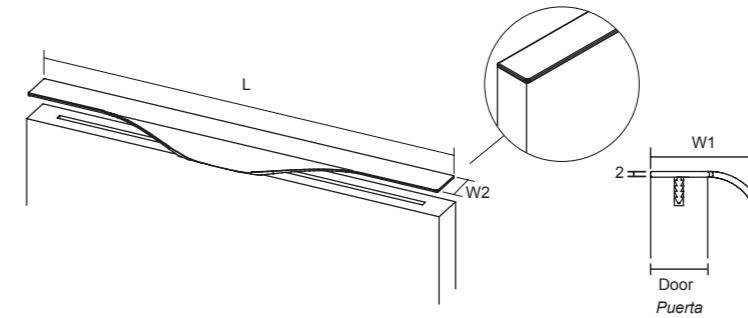

L24	L	W1	W2	Door
Stain. steel look Inox look				Puerta
0250147L24	147	38	19,8	15 19
0250197L24	197	38	19,8	15 19
0250247L24	247	38	19,8	15 19
0250297L24	297	38	19,8	15 19
0250347L24	347	38	19,8	15 19
0250397L24	397	38	19,8	15 19
0250447L24	447	38	19,8	10 19
0250497L24	497	38	19,8	10 19
0250597L24	597	38	19,8	10 19
0250697L24	697	38	19,8	10 19
0250797L24	797	38	19,8	10 19
0250897L24	897	38	19,8	5 19
0250997L24	997	38	19,8	5 19
02501197L24	1197	38	19,8	5 19

L24	L	W1	W2	Door
Stain. steel look Inox look				Puerta
0251147L24	147	40	21	15 20,5
0251197L24	197	40	21	15 20,5
0251247L24	247	40	21	15 20,5
0251297L24	297	40	21	15 20,5
0251347L24	347	40	21	15 20,5
0251397L24	397	40	21	15 20,5
0251447L24	447	40	21	10 20,5
0251497L24	497	40	21	10 20,5
0251597L24	597	40	21	10 20,5
0251697L24	697	40	21	10 20,5
0251797L24	797	40	21	10 20,5
0251897L24	897	40	21	5 20,5
0251997L24	997	40	21	5 20,5
02511197L24	1197	40	21	5 20,5

L24	L	W1	W2	Door
Stain. steel look Inox look				Puerta
0253147L24	147	40	22,8	15 22
0253197L24	197	40	22,8	15 22
0253247L24	247	40	22,8	15 22
0253297L24	297	40	22,8	15 22
0253347L24	347	40	22,8	15 22
0253397L24	397	40	22,8	15 22
0253447L24	447	40	22,8	10 22
0253497L24	497	40	22,8	10 22
0253597L24	597	40	22,8	10 22
0253697L24	697	40	22,8	10 22
0253797L24	797	40	22,8	10 22
0253897L24	897	40	22,8	5 22
0253997L24	997	40	22,8	5 22
02531197L24	1197	40	22,8	5 22

0334 **BRIKK** ALUMINIUM Designer: Alexis Vivet

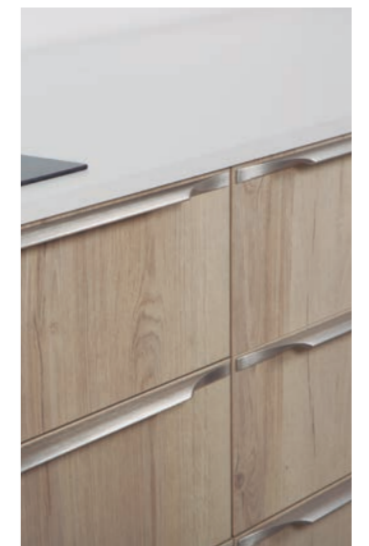
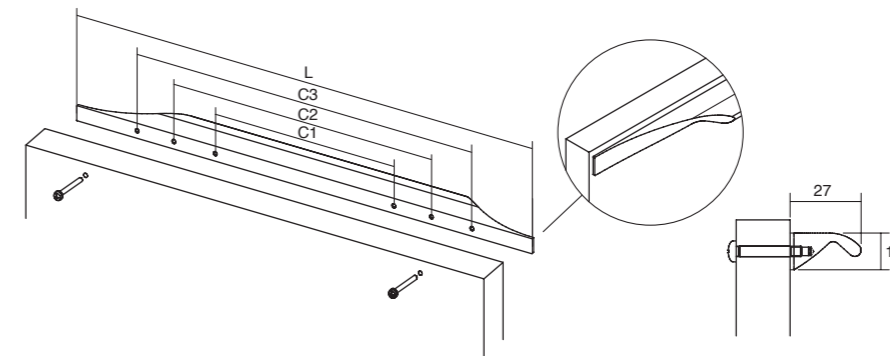

L24	L613	C1	C2	C3	L	↓	Door
Stainless steel look Inox look	Antique bronze Bronce antiguo						Puerta
0334140L24	0334140L613	32	-	-	140	2	15
0334190L24	-	64	-	-	190	2	15
0334240L24	-	96	-	-	240	2	15
0334290L24	0334290L613	160	-	-	290	2	15
0334340L24	-	192	-	-	340	2	15
0334390L24	-	128	260	-	390	4	15
0334440L24	-	160	310	-	440	4	10
0334490L24	0334490L613	192	360	-	490	4	10
0334590L24	-	224	460	-	590	4	10
0334690L24	-	256	560	-	690	4	10
0334790L24	-	320	660	-	790	4	10
0334890L24	-	384	760	-	890	4	5
0334990L24	-	320	640	860	990	6	5
03341190L24	03341190L613	320	832	1060	1190	6	5

0254/0255 **NOMA** ALUMINIUM Designer: 2J Design

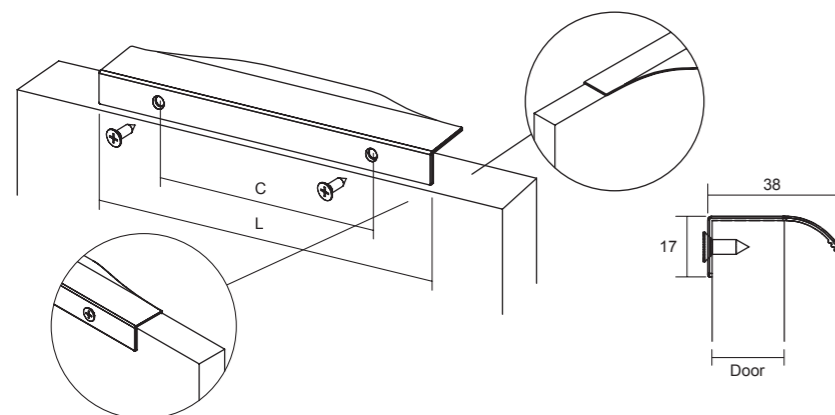

L02	L24	L30	L613	L618	C	L	↓	Door
Anodized bright Anodizado brillo	Stainless steel look Inox look	Brushed black Negro cepillado	Antique bronze Bronce antiguo	Brushed brass cava Latón cava cepillado				Puerta
0254128L02	0254128L24	0254128L30	0254128L613	0254128L618	128	200	2	25 19
0254256L02	0254256L24	0254256L30	0254256L613	0254256L618	256	350	2	25 19
-	0255128L24	-	-	-	128	200	2	25 22
-	0255256L24	-	-	-	256	350	2	25 22

0380 **STEEP** ALUMINIUM Designer: Viefe Studio

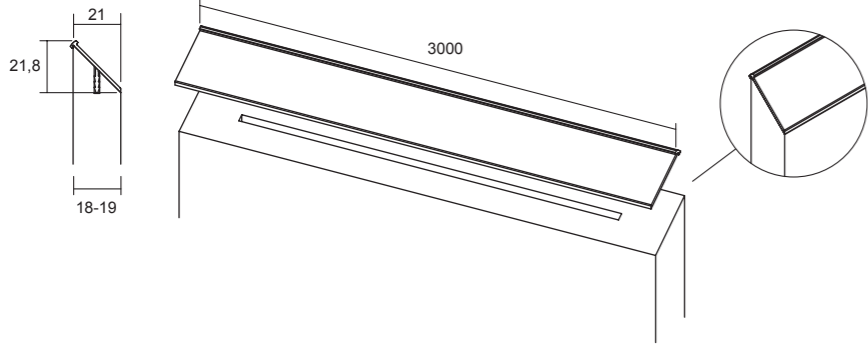

L02	L24	LM2	
Anodized bright Anodizado brillo	Stainless steel look Inox look	Matt black Negro mate	☐
03803000L02	03803000L24	03803000LM2	15 *

* Three metre profiles are delivered according to the units of the original packaging and cannot be sold separately.
Las barras de tres metros se sirven según las cantidades del embalaje original y no se pueden servir por separado.

0343 **GRADA** ALUMINIUM Designer: Viefe Studio

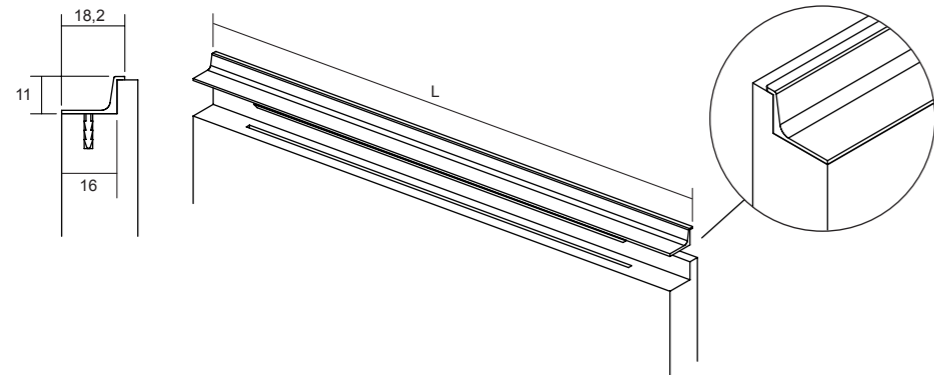

L02	L04	L24	LM1	LM2	L	☐
Anodized bright Anodizado brillo	Anodized matt Anodizado mate	Stainless steel look Inox look	Matt white Blanco mate	Matt black Negro mate		
-	0343147L04	0343147L24	0343147LM1	0343147LM2	147	15
-	0343197L04	0343197L24	0343197LM1	0343197LM2	197	15
-	0343247L04	0343247L24	0343247LM1	0343247LM2	247	15
-	0343297L04	0343297L24	0343297LM1	0343297LM2	297	15
-	0343347L04	0343347L24	0343347LM1	0343347LM2	347	15
-	0343397L04	0343397L24	0343397LM1	0343397LM2	397	15
-	0343447L04	0343447L24	0343447LM1	0343447LM2	447	10
-	0343497L04	0343497L24	0343497LM1	0343497LM2	497	10
-	0343597L04	0343597L24	0343597LM1	0343597LM2	597	10
-	0343697L04	0343697L24	0343697LM1	0343697LM2	697	10
-	0343797L04	0343797L24	0343797LM1	0343797LM2	797	10
-	0343897L04	0343897L24	0343897LM1	0343897LM2	897	5
-	0343997L04	0343997L24	0343997LM1	0343997LM2	997	5
-	03431197L04	03431197L24	03431197LM1	03431197LM2	1197	5
03433000L02	03433000L04	03433000L24	03433000LM1	03433000LM2	3000	15*

* Three metre profiles are delivered according to the units of the original packaging and cannot be sold separately.
Las barras de tres metros se sirven según las cantidades del embalaje original y no se pueden servir por separado.

0108 **TWISTED** ZAMAK Designer: Viefe Studio

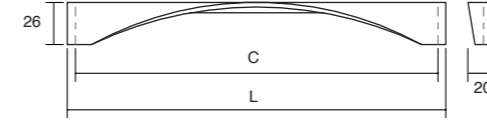

Z01	Z23	C	L	↓	☐
Polished chrome Cromo brillo	Brushed nickel Níquel cepillado				
0108160Z01	0108160Z23	160	170	2	25
0108224Z01	0108224Z23	224	234	2	25
0108320Z01	0108320Z23	320	340	2	25

0239 **ARA** ALUMINIUM Designer: 2J Design

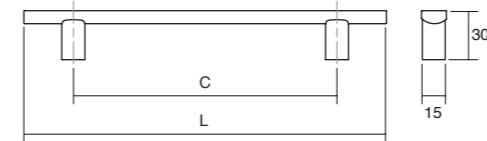

L24	C	L	↓	☐
Stain. steel look Inox look				
0239096L24	96	156	2	25
0239192L24	192	252	2	25
0239320L24	320	380	2	25

0219 **ARROW** ZAMAK Designer: 2J Design

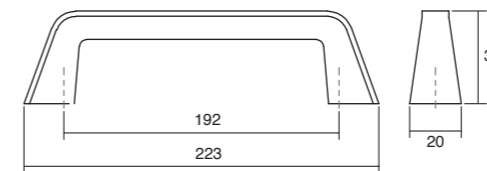

Z01	Z23	↓	☐
Polished chrome Cromo brillo	Brushed nickel Níquel cepillado		
0219192Z01	0219192Z23	2	25

0374 **BALL** ZAMAK Designer: Alexis Vivet

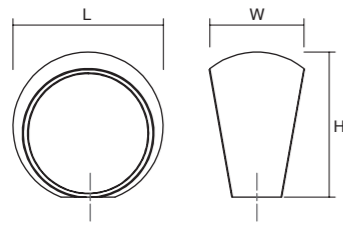

Z01	Z23	Z27	L	W	H	↓	☐
Polished chrome <i>Cromo brillo</i>	Brushed nickel <i>Níquel cepillado</i>	Brushed brass <i>Latón cepillado</i>					
0374024Z01	0374024Z23	0374024Z27	23,3	14,8	22,8	1	25
0374029Z01	0374029Z23	0374029Z27	29,5	18,3	28,8	1	25

0226 **REDO** ZAMAK Designer: 2J Design

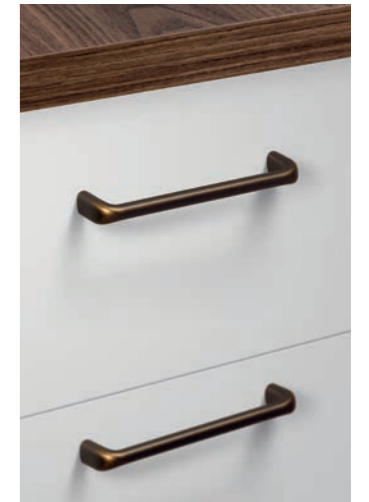
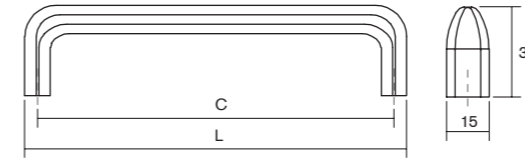

Z01	Z23	Z26	Z610	Z614	C	L	↓	☐
Polished chrome <i>Cromo brillo</i>	Brushed nickel <i>Níquel cepillado</i>	Brushed copper <i>Cobre cepillado</i>	Pewter <i>Peltre</i>	Antique Brass <i>Latón antiguo</i>				
0226128Z01	0226128Z23	0226128Z26	0226128Z610	0226128Z614	128	137	2	25
0226192Z01	0226192Z23	0226192Z26	0226192Z610	0226192Z614	192	201	2	25

0410 **BUTTON** ZAMAK Designer: Alexis Vivet

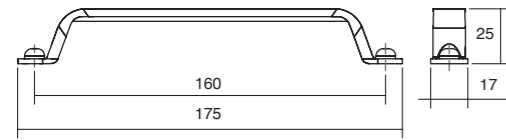

Z01	Z610	Z614	ZM2	↓	☐
Polished chrome <i>Cromo brillo</i>	Pewter <i>Peltre</i>	Antique Brass <i>Latón antiguo</i>	Matt black <i>Negro mate</i>		
0410160Z01	0410160Z610	0410160Z614	0410160ZM2	2	25

0405 **RAVIOLO** ZAMAK Designer: Balutto Associati

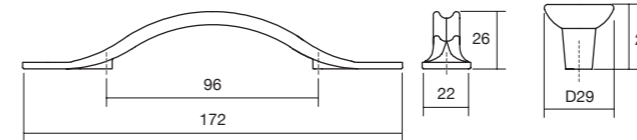

Z610	Z614	↓	☐
Pewter <i>Peltre</i>	Antique Brass <i>Latón antiguo</i>		
0405029Z610	0405029Z614	1	25
0405096Z610	0405096Z614	2	25

0393 **DUKE** ZAMAK Designer: Viefte Studio

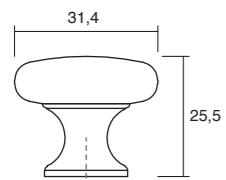

Z01	Z23	Z26	Z27	Z66	Z610	Z612	Z614	ZM1	ZM2	↓	☐
Pol. chrome <i>Cromo brillo</i>	Brushed nickel <i>Níquel cepill.</i>	Brushed copper <i>Cobre cepillado</i>	Brushed brass <i>Latón cepillado</i>	Antique copper <i>Cobre antiguo</i>	Pewter <i>Peltre</i>	Antique silver <i>Plata antigua</i>	Antique Brass <i>Latón antiguo</i>	Matt white <i>Blanco mate</i>	Matt black <i>Negro mate</i>		
0393031Z01	0393031Z23	0393031Z26	0393031Z27	0393031Z66	0393031Z610	0393031Z612	0393031Z614	0393031ZM1	0393031ZM2	1	25

0394 **AVA** ZAMAK Designer: Viefte Studio

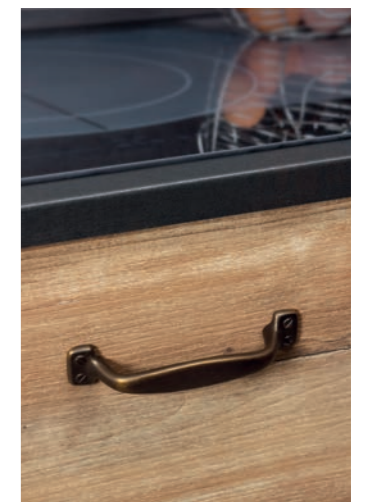
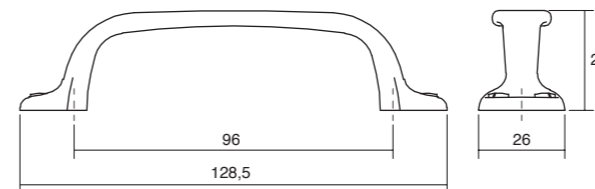

Z01	Z610	Z614	↓	☐
Polished Chrome <i>Cromo brillo</i>	Pewter <i>Peltre</i>	Antique Brass <i>Latón antiguo</i>		
0394096Z01	0394096Z610	0394096Z614	2	25

0390 **PETRA**

ZAMAK

Designer: Viefe Studio

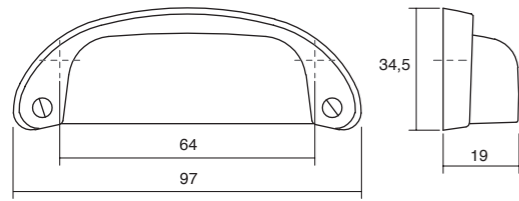

Z66 Z612 ZM2
 Antique copper Antique silver Matt black
 Cobre antiguo Plata antigua Negro mate

0390064Z66 0390064Z612 0390064ZM2 2 25



0404 **FLEXA**

LEATHER + ZAMAK

Designer: Balutto Associati

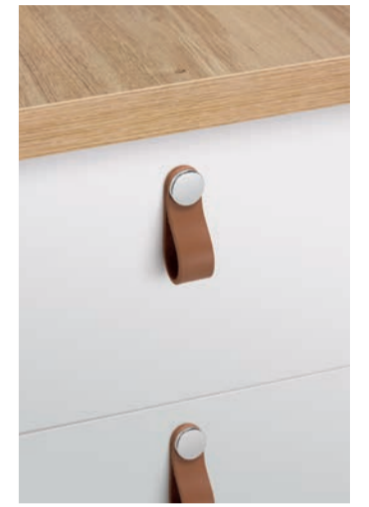
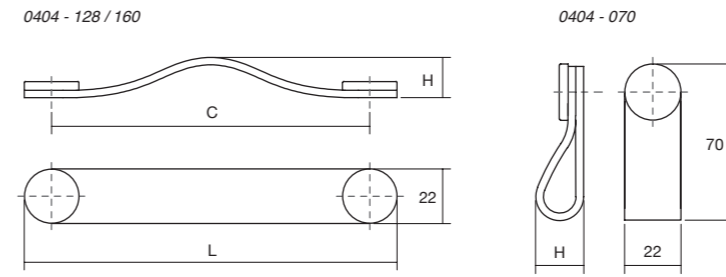

0391 **AURA**

ZAMAK

Designer: Viefe Studio

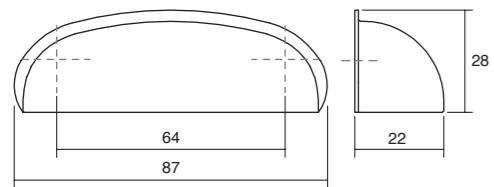

Z66 Z612
 Antique copper Antique silver
 Cobre antiguo Plata antigua

0391064Z66 0391064Z612 2 25



	P26 Beige / Beige	P36 Brown / Marrón	P99 Black / Negro	C	L	H	↓	☒
Z01 Polished chrome / Cromo brillo	0404070P2601	0404070P3601	0404070P9901	-	70	24	1	25
Z01 Polished chrome / Cromo brillo	0404128P2601	0404128P3601	0404128P9901	128	150	25	2	25
Z01 Polished chrome / Cromo brillo	0404160P2601	0404160P3601	0404160P9901	160	182	27	2	25
Z610 Pewter / Peltre	0404070P2610	0404070P3610	0404070P9910	-	70	24	1	25
Z610 Pewter / Peltre	0404128P2610	0404128P3610	0404128P9910	128	150	25	2	25
Z610 Pewter / Peltre	0404160P2610	0404160P3610	0404160P9910	160	182	27	2	25
ZM2 Black / Negro	0404070P26M2	0404070P36M2	0404070P99M2	-	70	24	1	25
ZM2 Black / Negro	0404128P26M2	0404128P36M2	0404128P99M2	128	150	25	2	25
ZM2 Black / Negro	0404160P26M2	0404160P36M2	0404160P99M2	160	182	27	2	25
Z27 Brass / Latón	0404070P2627	0404070P3627	0404070P9927	-	70	24	1	25
Z27 Brass / Latón	0404128P2627	0404128P3627	0404128P9927	128	150	25	2	25
Z27 Brass / Latón	0404160P2627	0404160P3627	0404160P9927	160	182	27	2	25

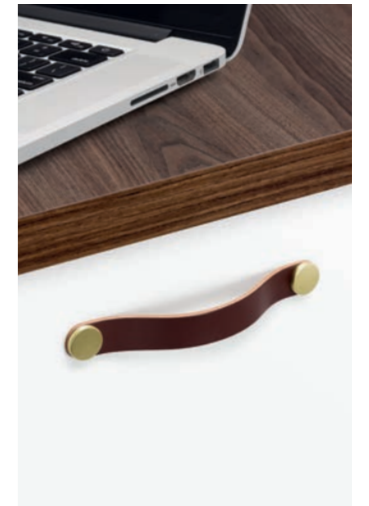

0392 **ORION**

ZAMAK

Designer: Viefe Studio

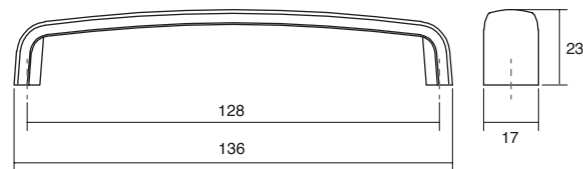

Z66 Z612
 Antique copper Antique silver
 Cobre antiguo Plata antigua

0392128Z66 0392128Z612 2 25

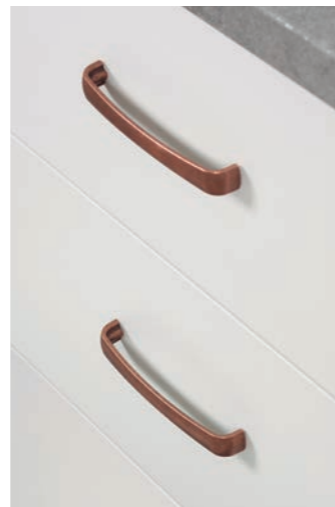

0239 **ARA W**

ALUMINIUM + WOOD

Designer: 2J Design

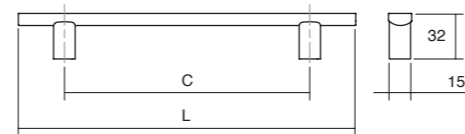

N2416 (L24+W16)	N2417 (L24+W17)	C	L	↓	☒
Stainless steel look + Oak	Stainless steel look + Walnut				
Inox look + Roble	Inox look + Nogal				
0239160N2416	0239160N2417	160	220	2	25
0239224N2416	0239224N2417	224	284	2	25



0340 **BARCCO** WOOD Designer: Alexis Vivet

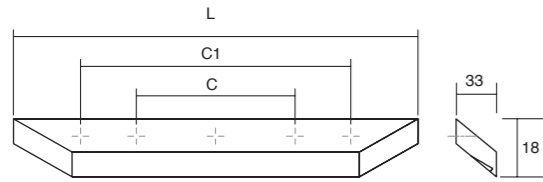

W18	W19	W00	C	C1	L	↓	☐
Ash <i>Fresno</i>	Walnut <i>Nogal</i>	Beech raw <i>Haya crudo</i>					
0340200W18	0340200W19	0340200W00	160	-	200	3	25
0340400W18	0340400W19	0340400W00	320	-	400	3	25
0340600W18	0340600W19	0340600W00	320	480	600	4	25

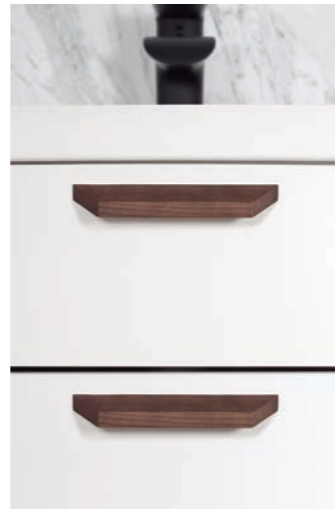

0167 **BALTO** WOOD Designer: Viefe Studio

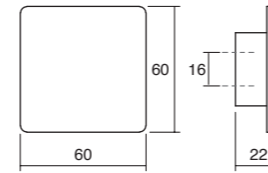

W00	W02	W08	W09	↓	☐
Raw brushed <i>Crudo cepillado</i>	White brushed <i>Blanco cepillado</i>	Brown brushed <i>Marrón cepillado</i>	Black brushed <i>Negro cepillado</i>		
0167016W00	0167016W02	0167016W08	0167016W09	2	25



0165 **CALIN** WOOD Designer: Viefe Studio

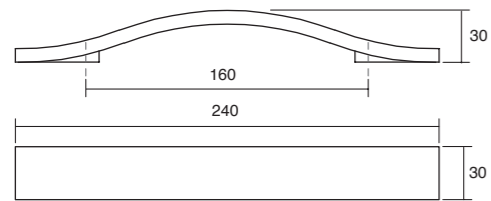

W00	W02	W08	W09	↓	☐
Raw brushed <i>Crudo cepillado</i>	White brushed <i>Blanco cepillado</i>	Brown brushed <i>Marrón cepillado</i>	Black brushed <i>Negro cepillado</i>		
0165160W00	0165160W02	0165160W08	0165160W09	2	25



0243 **LOW ST** ZAMAK Designer: Viefe Studio

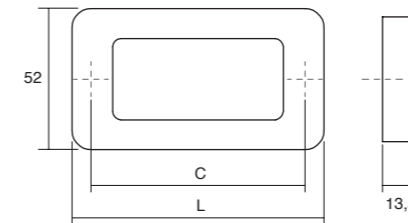

Z01	Z23	C	L	↓	☐
Polished chrome <i>Cromo brillo</i>	Brushed nickel <i>Níquel cepillado</i>				
0243064Z01ST	0243064Z23ST	64	78	2	25 With backplate / Con placa posterior
0243192Z01ST	0243192Z23ST	192	206	2	25 With backplate / Con placa posterior



0166 **ECHO** WOOD Designer: Viefe Studio

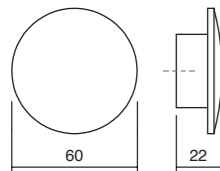

W00	W02	W08	W09	↓	☐
Raw brushed <i>Crudo cepillado</i>	White brushed <i>Blanco cepillado</i>	Brown brushed <i>Marrón cepillado</i>	Black brushed <i>Negro cepillado</i>		
0166060W00	0166060W02	0166060W08	0166060W09	1	25



0281 **FLAT** ZAMAK Designer: Oriol Barri

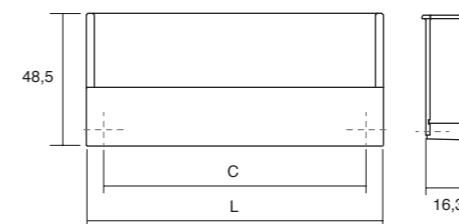

Z01	Z23	C	L	↓	☐
Polished chrome <i>Cromo brillo</i>	Brushed nickel <i>Níquel cepillado</i>				
0281160Z01	0281160Z23	160	174,8	2	25



0091 **RASO** ZAMAK Designer: Viefte Studio

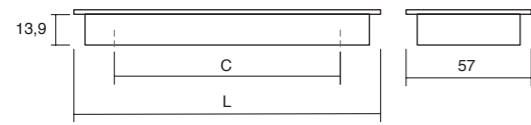

Z23	C	L	↓	☐
Brushed nickel <i>Níquel cepillado</i>				
0091032Z23	32	70	2	25
0091108Z23	108	152,5	2	25

0369 **RITTA** ALUMINIUM Designer: Teruel & Paré

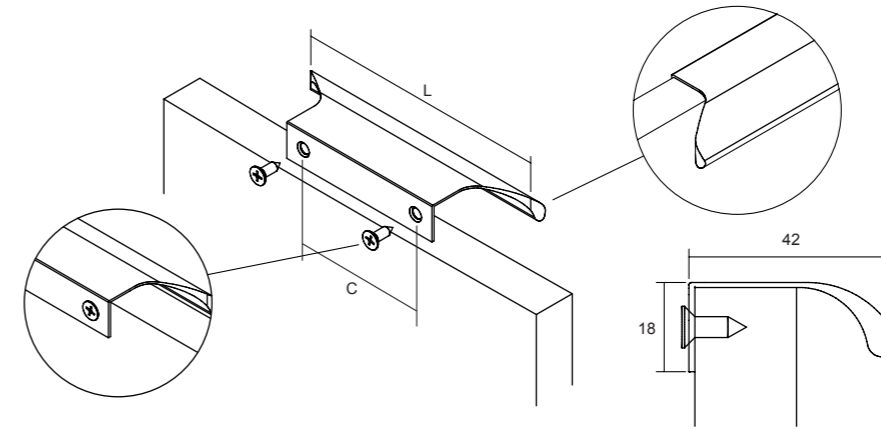

L01	L09	L24	C	L	↓	☐
Polished chrome <i>Cromo brillo</i>	Matt black <i>Negro mate</i>	Stainless steel look <i>Inox look</i>				
0369064L01	0369064L09	0369064L24	64	130	2	25
0369128L01	0369128L09	0369128L24	128	260	2	25

0208 **DUA** ZAMAK Designer: Viefte Studio

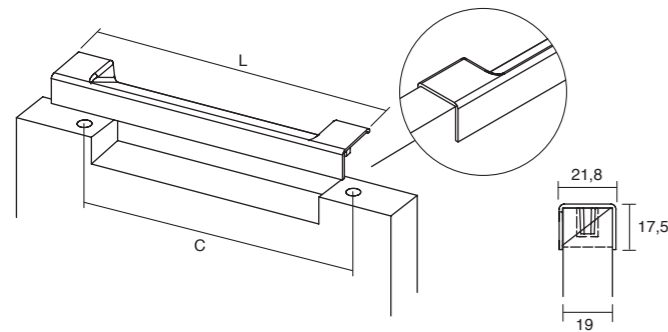

Z01	Z23	C	L	↓	☐	Door
Polished chrome <i>Cromo brillo</i>	Brushed nickel <i>Níquel cepillado</i>					
0208192Z01	0208192Z23	192	210	2	25	19mm

0249 **FERRI** STAINLESS STEEL Designer: Viefte Studio

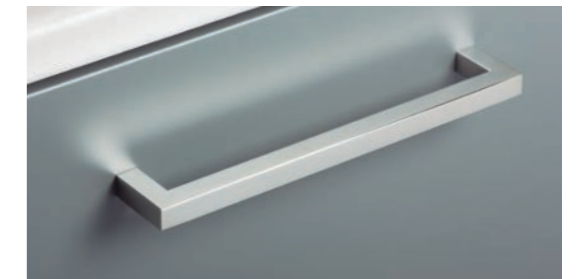
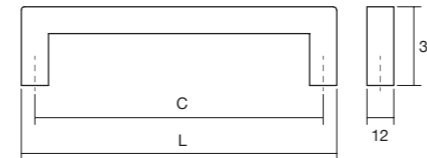

S25	C	L	↓	☐
Brushed stainless steel <i>Inox cepillado</i>				
0249128S25	128	140	2	25
0249160S25	160	172	2	25
0249192S25	192	204	2	25
0249320S25	320	332	2	25
0249512S25	512	524	2	25

0376 **BOXX** ZAMAK Designer: Alexis Vivet

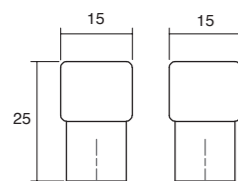

Z01	Z11	Z23	ZM2	↓	☐
Polished chrome <i>Cromo brillo</i>	Matt chrome <i>Cromo mate</i>	Brushed nickel <i>Níquel cepillado</i>	Matt black <i>Negro mate</i>		
0376012Z01	0376012Z11	0376012Z23	0376012ZM2	1	25

0076 **FORT** STAINLESS STEEL Designer: Viefte Studio

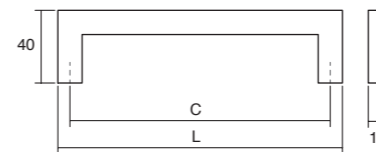

S25	C	L	↓	☐
Brushed stainless steel <i>Acero inox. cepillado</i>				
0076128S25	128	143	2	25
0076160S25	160	175	2	25
0076192S25	192	207	2	25
0076256S25	256	271	2	25
0076320S25	320	335	2	25
0076392S25	392	407	2	25
0076492S25	492	507	2	25
0076592S25	592	607	2	25
0076692S25	692	707	2	10



0064 **KOMBI** STAINLESS STEEL Designer: Viefe Studio

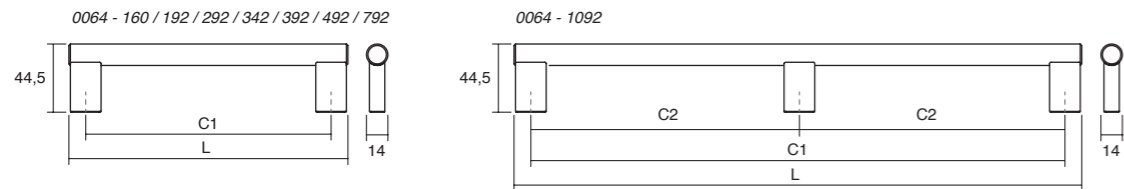

S25
Brushed stainless steel
Inox cepillado

	C1	C2	L	↓	☐
0064160S25	160	-	182	2	25
0064192S25	192	-	214	2	25
0064292S25	292	-	314	2	25
0064342S25	342	-	364	2	25
0064392S25	392	-	414	2	25
0064492S25	492	-	514	2	25
0064792S25	792	-	814	2	10
00641092S25	1092	546	1114	3	10



6005 **FONDA** ALUMINIUM Designer: Viefe Studio

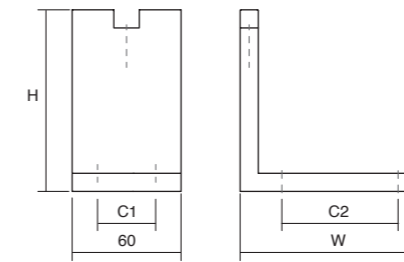

L01	L24	L29	L30	C1	C2	W	H	↓	☐
Polished chrome <i>Cromo brillo</i>	Stainless steel look <i>Inox look</i>	Brushed brass dark <i>Latón oscuro cepillado</i>	Brushed black <i>Negro cepillado</i>						
6005100L01	6005100L24	6005100L29	6005100L30	32	44	80	100	4	24
6005150L01	6005150L24	6005150L29	6005150L30	32	44	80	150	4	24
6005200L01	6005200L24	6005200L29	6005200L30	32	64	100	200	4	24



0312 **ARKO** ALUMINIUM Designer: Viefe Studio

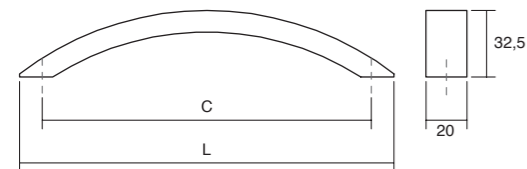

L24
Stain. steel look
Inox look

	C	L	↓	☐
0312160L24	160	186	2	25
0312192L24	192	218	2	25
0312256L24	256	292	2	25



0035 **ACER** STAINLESS STEEL Designer: 2J Design

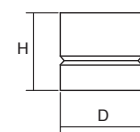

S25
Brushed stain. steel
Inox cepillado

	D	H	↓	☐
0035018S25	18	23	1	25
0035023S25	23	25	1	25
0035028S25	28	27	1	25



Finishes

IMPORTANT NOTE:

The finishes that you see represented in this section are a digital simulation of the real finishes and in no way can they be used as a reference for physical comparisons. The aim of this index is to guide and inform the user about the finishes we work with.

The finishes of all our models are defined exactly as is indicated in the catalogue and therefore are in no way characteristics that can be personalized.

NOTA IMPORTANTE:

Los acabados representados en esta sección son una simulación digital de los acabados reales y en ningún caso se pueden utilizar como referencia para comparativas físicas. Este índice se debe utilizar únicamente como orientación para conocer los acabados con los que trabaja Viefe.

Todos los diseños de Viefe tienen sus acabados definidos tal como indica el catálogo y, por lo tanto, no es una característica personalizable en ningún caso.

NOTA IMPORTANT:

Els acabats representats en aquesta secció són una simulació digital dels acabats reals i en cap cas es poden utilitzar com a referència per a comparatives físiques. Aquest índex s'ha d'utilitzar únicament com a orientació per conèixer els acabats amb els que treballa Viefe.

Tots els dissenys de Viefe tenen els seus acabats definits tal com indica el catàleg i per tant no és una característica personalitzable en cap cas.

ZAMAK

Glossy Brillante



Z01
Polished chrome
Cromo brillo



Z03
Polished black nickel
Níquel negro brillo



Z06
Polished copper
Cobre brillo



Z07
Polished brass
Latón brillo

Grey Gris

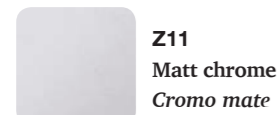

Z11
Matt chrome
Cromo mate



Z31
Brushed grey
Gris cepillado



Z32
Brushed mole grey
Gris topo cepillado



Z617
Graphite grey
Gris grafito



ZP1
Chrome look
Look cromo

Brass Latón



Z27
Brushed brass
Latón cepillado



Z28
Brushed gold
Oro cepillado



Z618
Brushed brass cava
Latón cava cepillado

White Blanco

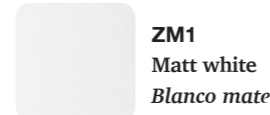

ZM1
Matt white
Blanco mate

Black Negro

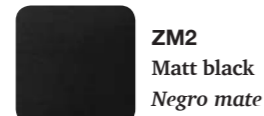

ZM2
Matt black
Negro mate

Color Color



ZM25
Moss grey
Gris musgo



ZM31
Green forest
Verde forest

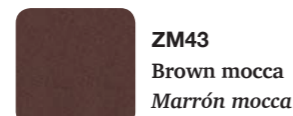

ZM43
Brown mocca
Marrón mocca

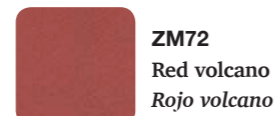

ZM72
Red volcano
Rojo volcano

Copper Cobre



Z26
Brushed copper
Cobre cepillado

Inox look Look inox



Z23
Brushed nickel
Níquel cepillado

Vintage Vintage

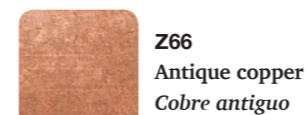

Z66
Antique copper
Cobre antiguo



Z610
Pewter
Peltre



Z612
Antique silver
Plata antigua



Z614
Antique brass
Latón antiguo

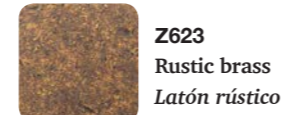

Z623
Rustic brass
Latón rústico



ZM22
Textured black
Negro texturizado

ALUMINIUM

Glossy Brillante

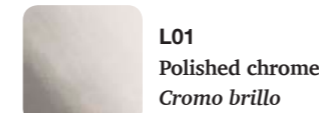

L01
Polished chrome
Cromo brillo

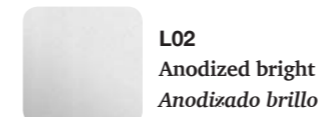

L02
Anodized bright
Anodizado brillo

Grey Gris

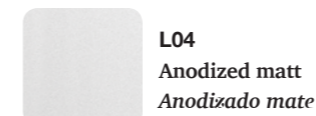

L04
Anodized matt
Anodizado mate



L31
Brushed grey
Gris cepillado



LM23
Metallic grey
Gris metal

Brass Latón



L29
Brushed dark brass
Latón oscuro cepillado

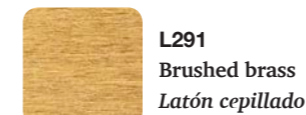

L291
Brushed brass
Latón cepillado



L618
Brushed brass cava
Latón cava cepillado

White Blanco

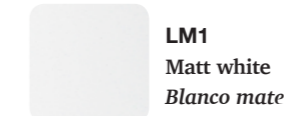

LM1
Matt white
Blanco mate

Black Negro

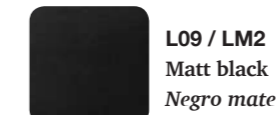

L09 / LM2
Matt black
Negro mate



L30
Brushed black
Negro cepillado

Color Color



LM41
Metallic brown
Marrón metal

Stainless steel look Look inox



L24
Stainless steel look
Inox look

Vintage Vintage

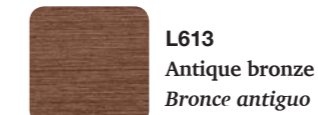

L613
Antique bronze
Bronce antiguo

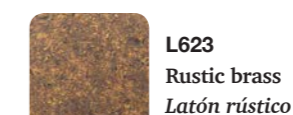

L623
Rustic brass
Latón rústico

STAINLESS STEEL



S25
Brushed stainless steel
Inox cepillado

WOOD



W00
Raw brushed
Crudo cepillado



W02
White brushed
Blanco cepillado



W08
Brown brushed
Marrón cepillado



W09
Black brushed
Negro cepillado

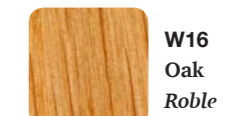

W16
Oak
Roble

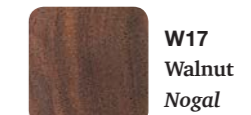

W17
Walnut
Nogal

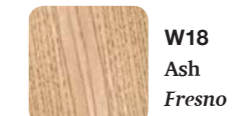

W18
Ash
Fresno



WM2
Ash matt black
lacquered
Fresno lacado negro
mate

LEATHER

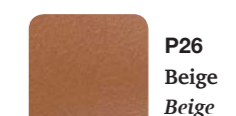

P26
Beige
Beige

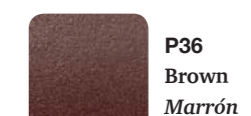

P36
Brown
Marrón

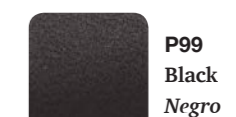

P99
Black
Negro

Number	Model	Product pag	Tech info pag
0035	ACER	251	300
0077	ANGLE	104 - 107	283
0239	ARA	221	291
0239	ARA W	236 - 237	295
0206	ARCH	250	283
0312	ARKO	247	300
0583	ARPA	56 - 61	267
0588	ARPA PLATE	52 - 55	266
0219	ARROW	249	291
0341	ASI	196 - 197	282
0391	AURA	233	294
0394	AVA	230	293
0374	BALL	245	292
0167	BALTO	241	297
0340	BARCCO	238 - 239	296
0496	BAU	110 - 111	268
0447	BELLA	168 - 169	278
0590	BELT	14 - 17	256
0489	BOL	142 - 143	271
0376	BOXX	246	298
0452	BRAVE	192 - 193	284
0334	BRIKK	212 - 213	289
0410	BUTTON	222 - 223	292
0165	CALIN	240	296
0235	CLOS	180 - 181	280
0168	COMO	118 - 121	270
0538	CONIC wood	82 - 83	263
0538	CONIC zamak	84 - 85	263
0366	CUBIC	182 - 183	280
0117	CURVE	202 - 203	287
0322	CUTT	218 - 219	284
0497	DIABOLO	122 - 123	270
0053	DINO	214 - 215	286
0556	DIPO	96 - 97	263
0530	DISC wood	74 - 75	262
0530	DISC zamak	76 - 77	262
0208	DUA	244	298
0393	DUKE	224 - 225	292
0166	ECHO	241	296
0614	EQUIS	44 - 45	262
0446	ESTE	166 - 167	274
0591	ETO	32 - 35	257
0451	FELTRE	190 - 191	278
0249	FERRI	248	299
0506	FIRM	62 - 67	275
0610	FLAPP aluminium	24 - 27	258
0613	FLAPP wood	28 - 31	258
0281	FLAT	243	297
0404	FLEXA	234 - 235	295
0495	FLOID	108 - 109	268
0542	FOLD	86 - 89	265
6005	FONDA	252 - 253	301
0250 / 0251 / 0253	FORMA	211	289
0076	FORT	249	299

0343	GRADA	208 - 209	290
0109	GRAF	162 - 163	278
0486	GRAF BIG	154 - 159	277
0430	GRAF MINI	160 - 161	277
0449	HEXXA	170 - 173	279
0094	HIDE	174 - 175	276
0127	JEY	112 - 115	269
0163	JEY2	114 - 115	269
0162	KADO	250	282
0064	KOMBI	251	300
0494	LAND	146 - 149	274
0139 / 0140	LINEAR	204 - 205	287
0459	LINES	164 - 165	275
0243 ST	LOW ST	242	297
0536	LUV	78 - 81	261
0105	NEST	178 - 179	280
0373	NICK	216 - 217	282
0254 / 0255	NOMA	102 - 103	288
0507	OBLONG	144 - 145	273
0601	OH! wood	36 - 37	259
0601	OH! zamak	38 - 39	259
0372	ONA	98 - 101	286
0392	ORION	232	294
0553	OTO	94 - 95	265
0444	PEAK	194 - 195	285
0516	PENDANT	150 - 153	276
0390	PETRA	231	294
0597	PLIÉ	18 - 19	256
0604	PRISMA	46 - 47	260
0487	PURA	116 - 117	268
0616	QUART big	50 - 51	260
0608	QUART mini	48 - 49	260
0511	RAIL	130 - 133	272
0091	RASO	247	298
0405	RAVIOLO	228 - 229	293
0226	REDO	226 - 227	293
0528	RILLE	68 - 73	261
0552	RIM	92 - 93	264
0369	RITTA	248	299
0241	ROMA	138 - 141	273
0499	ROUND	124 - 125	270
0195	SENSE	188 - 189	281
0301	SENSE MINI	186 - 187	281
0543	SOFT	90 - 91	264
0380	STEEP	210	290
0073	TAP	184 - 185	281
0108	TWISTED	220	291
0056	U	134 - 137	272
0602	VALLEY	40 - 43	259
0375	VANN	198 - 201	285
0434 / 0435 / 0436	VECTOR	206 - 207	288
0119	WAVE	176 - 177	279
0518	WAY	126 - 129	271
0600	WING	20 - 23	257

20
23

Viefe[®]

**HANDLES & KNOBS
CATALOGUE**

 **viefe.com**

Viefe®

20
23

 viefe.com

viefe.com/news

info@viefe.com
T +34 938584029

C/ Dels Traginers 2
Sant Pere de Torelló
08572 Barcelona, Spain