

OPEN  
YOUR  
MIND

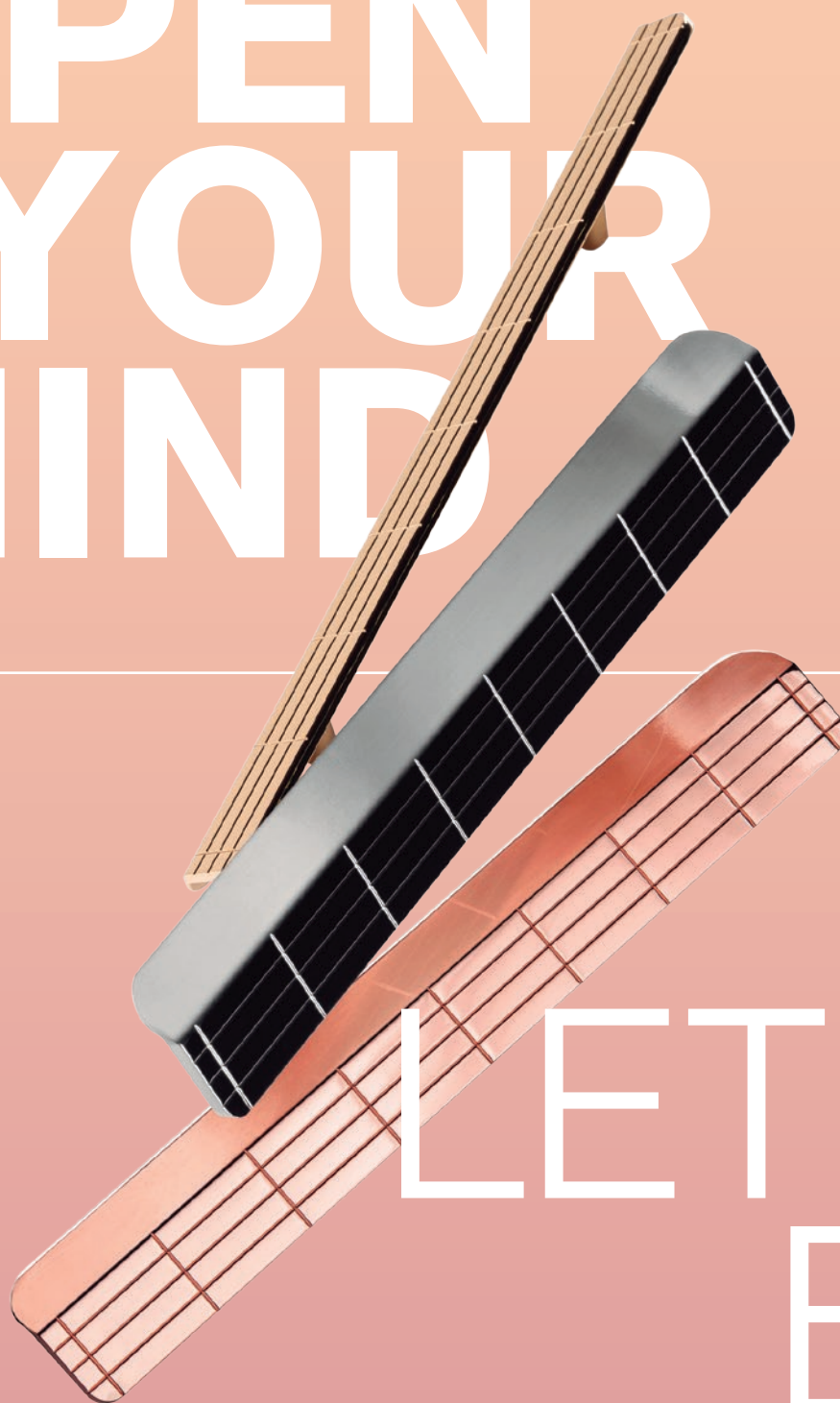

&  
LET IT  
BE

---

**Viefe**<sup>®</sup> handles

---

**OPEN YOUR MIND TO**

# **NEW IDEAS**

---

**to new ideas. To surprising designs. To the modern reinvention of classic shapes. To the creation of new concepts. To accessories that can completely transform furniture. To innovative materials with a fashionable finish. To miniscule details that can make a huge difference. To designers that leave their mark in everything that they do. To production processes that are respectful to both people and the planet. To simple set-ups that provide sophisticated results. To knobs that fit into their final destination with maximum precision. To handles that open up a world of infinite possibilities in decoration. To those who dream them up and to those who create them.**

#### **Abre tu mente**

a nuevas ideas. A diseños sorprendentes. A la reinención moderna de las formas clásicas. A la creación de nuevos conceptos. A complementos que transforman por completo un mueble. A materiales innovadores con acabados de tendencia. A detalles minúsculos que marcan grandes diferencias. A diseñadores que dejan huella en todo lo que hacen. A procesos productivos respetuosos con las personas y con el planeta. A montajes simples que dan resultados sofisticados. A pomos que encajan en su destino final con la máxima precisión. A tiradores que abren un mundo de infinitas posibilidades en decoración. A quienes los sueñan y a quienes los crean.

#### **Obre la teva ment**

a noves idees. A dissenys sorprenents. A la reinenció moderna de les formes clàssiques. A la creació de nous conceptes. A complementos que transformen absolutament un moble. A materials innovadors amb acabats de tendència. A detalls minúsculs que marquen grans diferències. A dissenyadors que deixen empremta en tot allò que fan. A processos productius respectuosos amb les persones i amb el planeta. A muntatges simples que donen resultats sofisticats. A poms que encaixen en la seva destinació final amb la màxima precisió. A tiradors que obren un món d'infinites possibilitats en decoració. A les persones que els somien i a les que els creen.



0495

**FLOID**

ZAMAK

Designer: Frank Person

**NEW!**

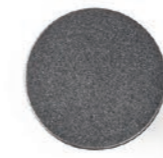

**Finishes**  
**Acabados**

Brushed gold  
*Oro cepillado*

Pewter  
*Peltre*

Antique brass  
*Latón antiguo*

Matt black  
*Negro mate*

← →	o — o
Ø34,8 mm	-
143,6 mm	128 mm
207,6 mm	192 mm

⊕  
Technical info on page 236  
*Info técnica en pág 236*



0496

**BAU**

ZAMAK

Designer: Patricia Roig

**NEW!**



**Finishes**  
**Acabados**

Brushed nickel  
*Níquel cepillado*

Brushed gold  
*Oro cepillado*

Matt black  
*Negro mate*



90 mm



64 mm



Technical info on page 236  
*Info técnica en pág 236*

Patricia.R

# PATRICIA ROIG

Where:

Spain

Designs:

Bau

Philosophy:

**Balance between simplicity  
and functionality**

*Equilibrio entre simplicidad y  
funcionalidad*

*Equilibri entre simplicitat i  
funcionalitat*

 @roigdesign



0127

**JEY**

ALUMINIUM

Designer: Viefe®



**Finishes**  
**Acabados**

Stainless steel look  
*Inox look*

**NEW!** Brushed brass cava  
*Latón cava cepillado*

Matt white  
*Blanco mate*

Matt black  
*Negro mate*

←→

147 mm

197 mm

247 mm

297 mm

347 mm

397 mm

447 mm

497 mm

597 mm

697 mm

797 mm

897 mm

997 mm

1197 mm

3000 mm\*

\* Available only in M1  
and M2 finishes

*Disponible solo en los  
acabados M1 y M2*



Technical info on page 237  
*Info técnica en pág 237*



0127 **JEY**

0163 **JEY2** (above)

ALUMINIUM

Designer: Viefef®

**Finishes**  
**Acabados**

Stainless steel look  
*Inox look*

**NEW!** Brushed brass cava  
*Latón cava cepillado*

Matt white  
*Blanco mate*

Matt black  
*Negro mate*

←→|

147 mm

197 mm

247 mm

297 mm

347 mm

397 mm

447 mm

497 mm

597 mm

697 mm

797 mm

897 mm

997 mm

1197 mm

3000 mm\*

\* Available only in M1  
and M2 finishes

*Disponible solo en los  
acabados M1 y M2*



Technical info on page 237  
*Info técnica en pág 237*





0487

**PURA**

ZAMAK

Designer: Balutto Associati

**NEW!**



**Finishes**  
**Acabados**

Polished chrome  
*Cromo brillo*

Polished black nickel  
*Nickel negro brillo*

Polished copper  
*Cobre brillo*

Polished brass  
*Latón brillo*

←→

168 mm

o — o

160 mm



Technical info on page 236  
*Info técnica en pág 236*



0168

**COMO**

ZAMAK

Designer: Viefef®



**Finishes  
Acabados**

Polished chrome  
*Cromo brillo*

**NEW!** Polished black nickel  
*Niquel negro brillo*

**NEW!** Polished copper  
*Cobre brillo*

**NEW!** Polished brass  
*Latón brillo*



26 mm  
41 mm



Technical info on page 238  
*Info técnica en pág 238*



0168

**COMO**

ZAMAK

Designer: Viefef®

**Finishes**  
**Acabados**

Matt chrome  
*Cromo mate*

Brushed nickel  
*Níquel cepillado*

Brushed copper  
*Cobre cepillado*

Brushed gold  
*Oro cepillado*

Matt black  
*Negro mate*

Matt white  
*Blanco mate*



26 mm  
41 mm



Technical info on page 238  
*Info técnica en pág 238*



0497

# DIABOLO

ALUMINIUM

Designer: Frank Person

**NEW!**



### Finishes Acabados

Stainless steel look  
*Inox look*

Brushed dark brass  
*Latón oscuro cepillado*

Brushed black  
*Negro cepillado*

Brushed grey  
*Gris cepillado*



13,5 mm



Technical info on page 238  
*Info técnica en pág 238*



# FRANK PERSON

Where:

**Germany**

Designs:

**Floid,  
Diabolo,  
Firm, Oblong,  
Pendant**

Philosophy:

**Concept, design and realisation**

*Concepto, diseño y realización*

*Concepte, disseny i realització*

 [www.fpformgebung.com](http://www.fpformgebung.com)

 [@frank.person](https://www.instagram.com/frank.person)



0499

**ROUND**

ALUMINIUM

Designer: Balutto Associati

**NEW!**



**Finishes**  
**Acabados**

Stainless steel look  
*Inox look*

Brushed dark brass  
*Latón oscuro cepillado*

Brushed black  
*Negro cepillado*



25 mm



Technical info on page 238  
*Info técnica en pág 238*



0490

# SWITCH

ZAMAK

Designer: Viefel®

**NEW!**



**Finishes**  
**Acabados**

Brushed nickel  
*Níquel cepillado*

Matt white  
*Blanco mate*

Matt black  
*Negro mate*

←→	o — o
50 mm	32 mm
200 mm	160 mm

⊕  
Technical info on page 239  
*Info técnica en pág 239*



0518

**WAY**

ALUMINIUM

Designer: Viefel®

**NEW!**



**Finishes**  
**Acabados**

	←→	○ — ○ 1	○ — ○ 1/2	○ — ○ 2
Anodized matt <i>Anodizado mate</i>	50 mm	32 mm	-	-
	100 mm	64 mm	-	-
Stainless steel look <i>Inox look</i>	200 mm	128 mm	-	-
	400 mm	320 mm	-	-
Brushed dark brass <i>Latón oscuro cepillado</i>	800 mm	736 mm	368 mm	-
Matt White <i>Blanco mate</i>	1100 mm	1056 mm	-	352 mm
Matt black <i>Negro mate</i>				

⊕  
Technical info on page 239  
*Info técnica en pág 239*



0518

**WAY**

ALUMINIUM

Designer: Viefe®

**NEW!**

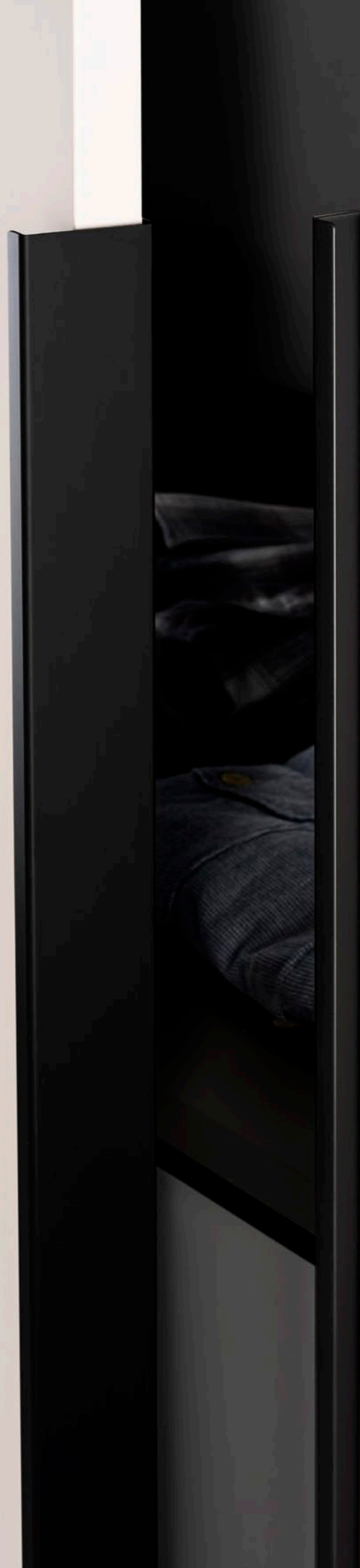

**Finishes**  
**Acabados**

Anodized matt  
*Anodizado mate*

Stainless steel look  
*Inox look*

Brushed dark brass  
*Latón oscuro cepillado*

Matt White  
*Blanco mate*

Matt black  
*Negro mate*

←→	o — o 1	o — o 1/2	o — o 2
50 mm	32 mm	-	-
100 mm	64 mm	-	-
200 mm	128 mm	-	-
400 mm	320 mm	-	-
800 mm	736 mm	368 mm	-
1100 mm	1056 mm	-	352 mm

⊕  
Technical info on page 239  
*Info técnica en pág 239*



0511

# RAIL

ALUMINIUM

Designer: Teruel & Paré

**NEW!**



### Finishes Acabados

Stainless steel look  
*Inox look*

Brushed black  
*Negro cepillado*

Brushed brass cava  
*Latón cava cepillado*

←→	o — o 1	o — o 2
180 mm	160 mm	-
280 mm	192 mm	-
600 mm	576 mm	192 mm
* 1150 mm	1120 mm	192 mm

\* Off-center / *Descentrado*

⊕  
Technical info on page 240  
*Info técnica en pág 240*



0511

**RAIL**

ALUMINIUM

Designer: Teruel & Paré

**NEW!**



**Finishes**

**Acabados**

Stainless steel look  
*Inox look*

Brushed black  
*Negro cepillado*

Brushed brass cava  
*Latón cava cepillado*

←→	o — o 1	o — o 2
180 mm	160 mm	-
280 mm	192 mm	-
600 mm	576 mm	192 mm
* 1150 mm	1120 mm	192 mm

\* Off-center / *Descentrado*

⊕  
Technical info on page 240  
*Info técnica en pág 240*

---

# 1.

---

**Viefe**<sup>®</sup>

OPEN YOUR MIND TO

# MINISCULE DETAILS THAT CAN MAKE A HUGE DIFFERENCE

---

ABRE TU MENTE A

detalles minúsculos que  
marcan grandes diferencias

*ESP*

OBRE LA TEVA MENT A

detalls minúsculs que marquen  
grans diferències

*CAT*

---

*Principle number 1*

*Our Manifesto*

---



0056

U

ZAMAK

Designer: Viefe®



**Finishes**  
**Acabados**

**NEW!** Matt white  
Blanco mate

←→	o — o
136,5 mm	128 mm
168,5 mm	160 mm
200,5 mm	192 mm
328,5 mm	320 mm
500,5 mm	492 mm

⊕  
Technical info on page 240  
Info técnica en pág 240



0056

U

ZAMAK

Designer: Viefef®

**Finishes**  
**Acabados**

	←→	o — o
Polished chrome <i>Cromo brillo</i>	136,5 mm	128 mm
Matt chrome <i>Cromo mate</i>	168,5 mm	160 mm
Brushed nickel <i>Niquel cepillado</i>	200,5 mm	192 mm
	328,5 mm	320 mm
	500,5 mm	492 mm
Matt black <i>Negro mate</i>		
Brushed copper <i>Cobre cepillado</i>		
Brushed brass <i>Latón cepillado</i>		
<b>NEW!</b> Matt white <i>Blanco mate</i>		
Brushed grey <i>Gris cepillado</i>		



Technical info on page 240  
*Info técnica en pág 240*



0241

**ROMA**

ZAMAK

Designer: 2J Design

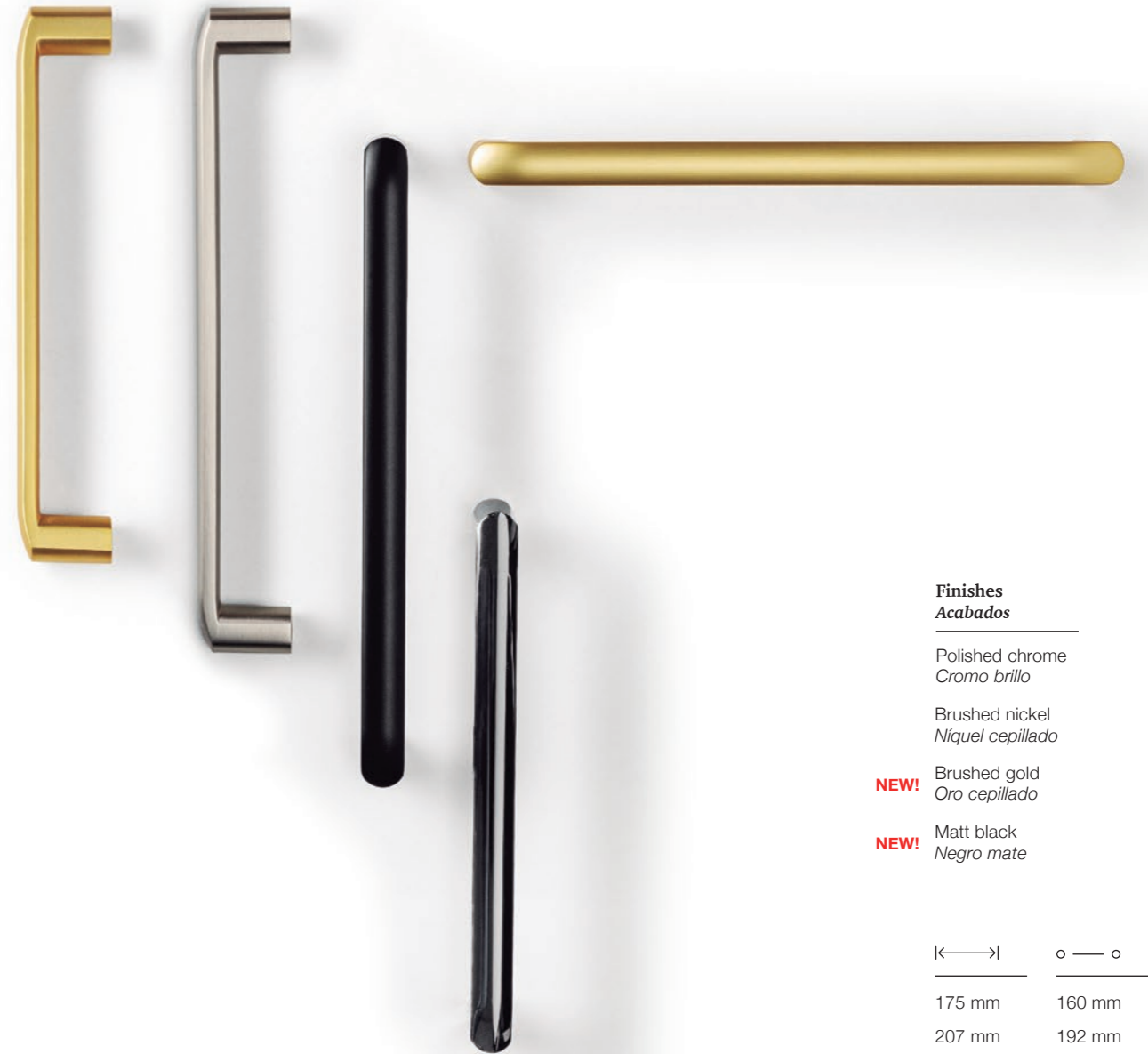

**Finishes**  
**Acabados**

Polished chrome  
*Cromo brillo*

Brushed nickel  
*Níquel cepillado*

**NEW!** Brushed gold  
*Oro cepillado*

**NEW!** Matt black  
*Negro mate*

← →	o — o
175 mm	160 mm
207 mm	192 mm
335 mm	320 mm

⊕  
Technical info on page 241  
*Info técnica en pág 241*



0241

# ROMA

ZAMAK

Designer: 2J Design

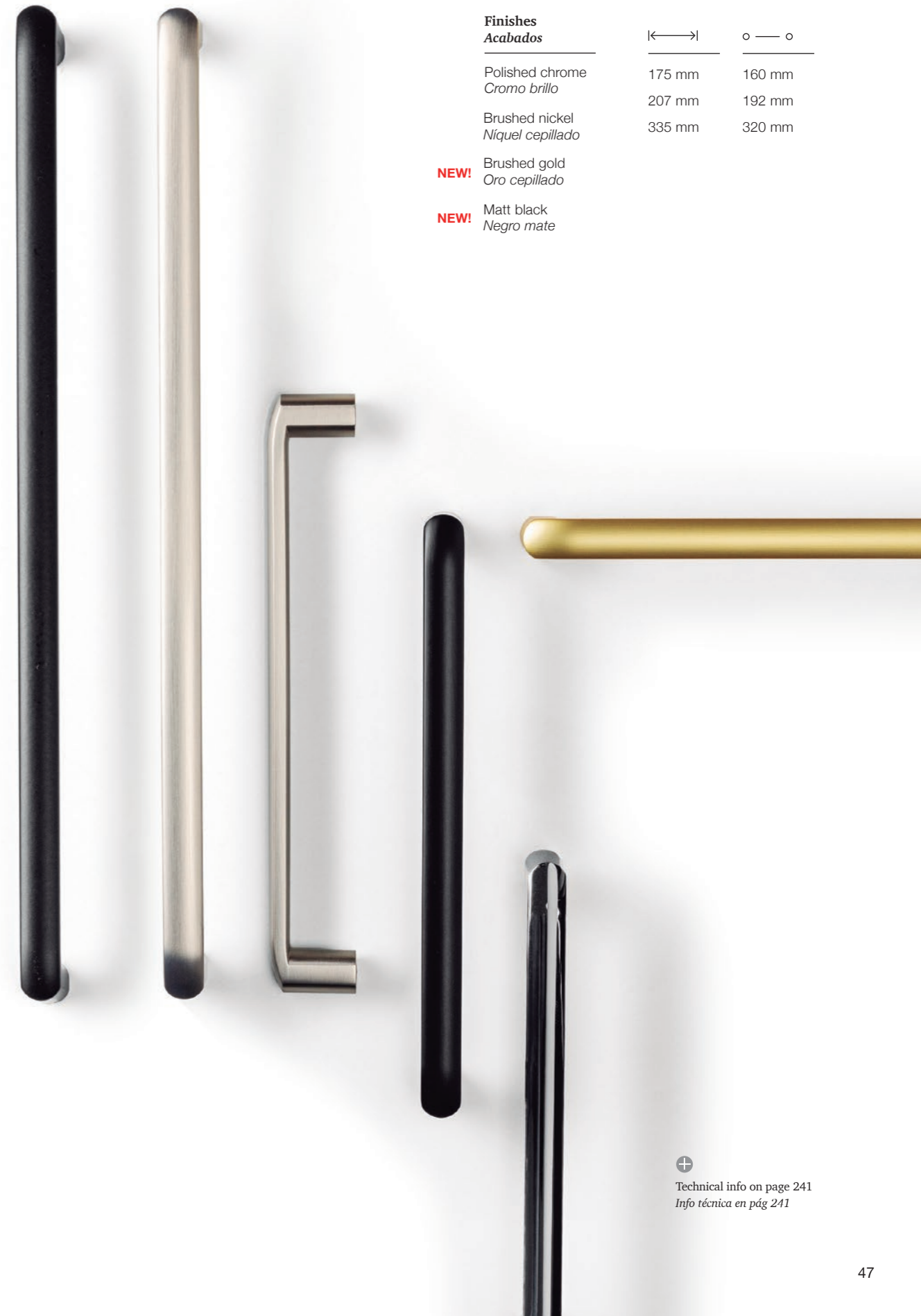

**Finishes**  
**Acabados**

Polished chrome  
*Cromo brillo*  
Brushed nickel  
*Níquel cepillado*

←→

175 mm

207 mm

335 mm

o — o

160 mm

192 mm

320 mm

**NEW!** Brushed gold  
*Oro cepillado*

**NEW!** Matt black  
*Negro mate*



Technical info on page 241  
*Info técnica en pág 241*





0503

# WALLACE

ZAMAK

Designer: Alexis Vivet

NEW!

## Finishes Acabados

Polished chrome  
*Cromo brillo*

Polished black nickel  
*Níquel negro brillo*

Polished copper  
*Cobre brillo*

Polished brass  
*Latón brillo*

←→ |    o — o  
210 mm    128 mm

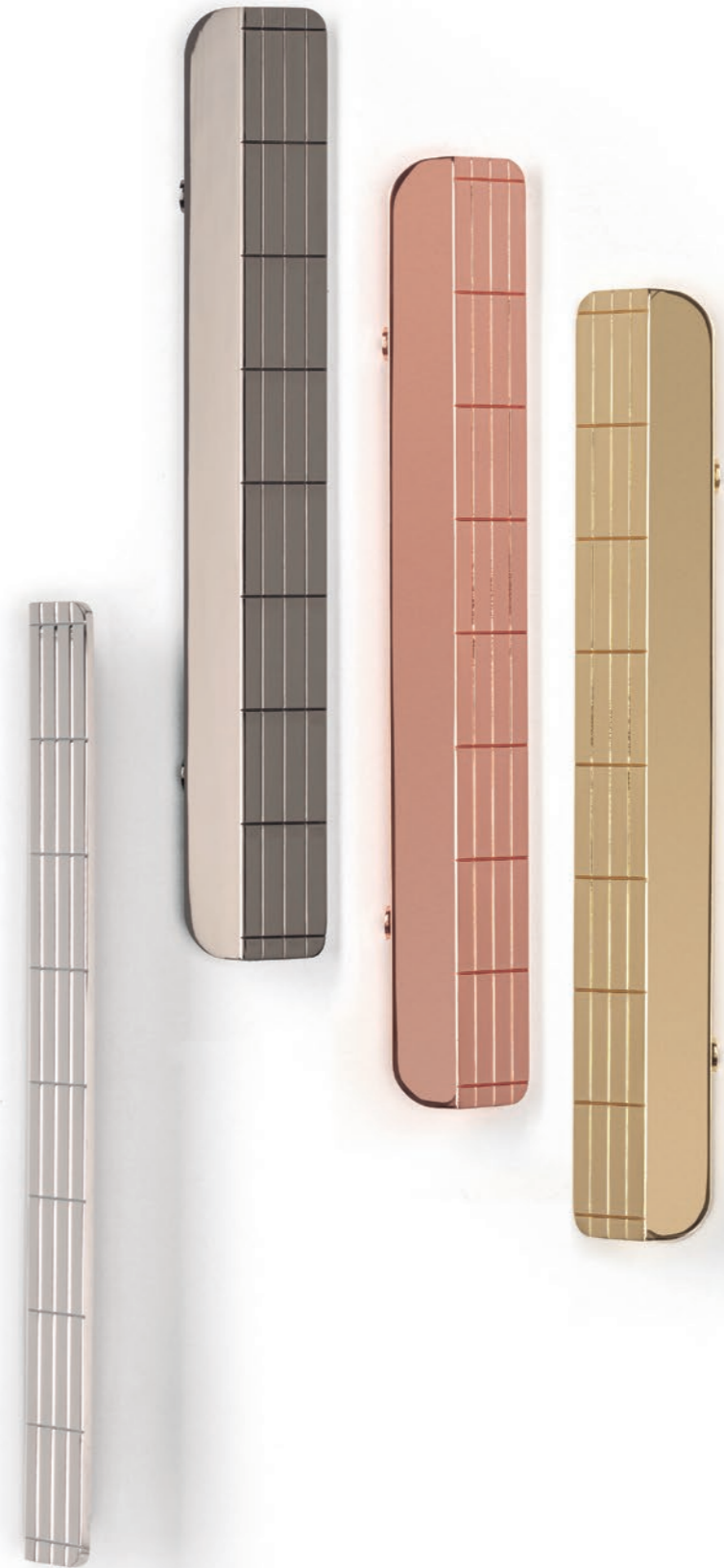

⊕  
Technical info on page 241  
*Info técnica en pág 241*



0489

# BOL

ZAMAK / WOOD

Designer: Balutto Associati

**NEW!**

## Finishes Acabados

Matt black + Sapelly  
*Negro mate + Sapelly*

Matt black + Beech  
*Negro mate + Haya*

Matt black + Matt white lacquered  
*Negro mate + Lacado blanco mate*



45 mm



Technical info on page 241  
*Info técnica en pág 241*



0507

# OBLONG

LEATHER / ZAMAK

Designer: Frank Person

**NEW!**

## Finishes Acabados

Polished chrome + Beige / Brown / Black  
*Cromo brillo + Beige / Marrón / Negro*

Brushed gold + Beige / Brown / Black  
*Oro cepillado + Beige / Marrón / Negro*

Brushed grey + Beige / Brown / Black  
*Gris cepillado + Beige / Marrón / Negro*

Matt white + Beige  
*Blanco mate + Beige*

Matt black + Beige / Brown / Black  
*Negro mate + Beige / Marrón / Negro*



↳ — ↳	○ — ○
70 mm	-
197 mm	160 mm



Technical info on page 242  
*Info técnica en pág 242*

0507

# OBLONG

LEATHER / ZAMAK

Designer: Frank Person

NEW!



### Finishes Acabados

Polished chrome + Beige / Brown / Black  
*Cromo brillo + Beige / Marrón / Negro*

Brushed gold + Beige / Brown / Black  
*Oro cepillado + Beige / Marrón / Negro*

Brushed grey + Beige / Brown / Black  
*Gris cepillado + Beige / Marrón / Negro*

Matt white + Beige  
*Blanco mate + Beige*

Matt black + Beige / Brown / Black  
*Negro mate + Beige / Marrón / Negro*

←→	o — o
70 mm	-
197 mm	160 mm

⊕  
 Technical info on page 242  
*Info técnica en pág 242*

---

# 2.

---

OPEN YOUR MIND TO

# SIMPLE SET-UPS THAT PROVIDE SOPHISTICATED RESULTS

---

ABRE TU MENTE A

montajes simples que dan  
resultados sofisticados

*ESP*

OBRE LA TEVA MENT A

muntatges simples que donen  
resultats sofisticats

*CAT*



0494

**LAND**

ZAMAK

Designer: Héctor Diego

**NEW!**



**Finishes**  
*Acabados*

Brushed gold  
*Oro cepillado*

Pewter  
*Peltre*

Antique brass  
*Latón antiguo*

Matt black  
*Negro mate*

|←→|      o — o

40 (Ø) mm      -

98 mm      64 mm

⊕  
Technical info on page 243  
*Info técnica en pág 243*



0494

**LAND**

ZAMAK

Designer: Héctor Diego

**NEW!**



**Finishes  
Acabados**

Brushed gold  
*Oro cepillado*

Pewter  
*Peltre*

Antique brass  
*Latón antiguo*

Matt black  
*Negro mate*

←→	○ — ○
40 (Ø) mm	-
98 mm	64 mm

⊕  
Technical info on page 243  
*Info técnica en pág 243*



0506

**FIRM**

ZAMAK

Designer: Frank Person

**NEW!**



**Finishes**  
**Acabados**

Textured black  
*Negro texturizado*

←→	o — o
93,8 mm	64 mm
125,8 mm	96 mm
189,8 mm	160 mm
349,8 mm	320 mm

⊕  
Technical info on page 244  
*Info técnica en pág 244*





0506

**FIRM**

ZAMAK

Designer: Frank Person

**NEW!**

**Finishes**  
**Acabados**

Textured black  
*Negro texturizado*

←→	○ — ○
93,8 mm	64 mm
125,8 mm	96 mm
189,8 mm	160 mm
349,8 mm	320 mm



Technical info on page 244  
*Info técnica en pág 244*



0516

# PENDANT

ZAMAK

Designer: Frank Person

NEW!



**Finishes**  
**Acabados**

Pewter  
*Peltre*

Antique brass  
*Latón antiguo*

Matt black  
*Negro mate*

←→	o — o
39,3 mm	-
138,4 mm	128 mm

⊕  
Technical info on page 245  
*Info técnica en pág 245*



0516

# PENDANT

ZAMAK

Designer: Frank Person

NEW!



**Finishes**  
**Acabados**

Pewter  
*Peltre*

Antique brass  
*Latón antiguo*

Matt black  
*Negro mate*

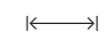

39,3 mm

138,4 mm

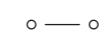

-

128 mm



Technical info on page 245  
*Info técnica en pág 245*

6005

**FONDA**

ALUMINIUM

Designer: Viefe®



**Finishes**  
**Acabados**

	↕
Polished chrome <i>Cromo brillo</i>	100 mm
Stainless steel look <i>Inox look</i>	150 mm
<b>NEW!</b> Brushed dark brass <i>Latón oscuro cepillado</i>	200 mm
Brushed black <i>Negro cepillado</i>	



Technical info on page 278  
*Info técnica en pág 278*

---

# 3.

---

**Viefe**<sup>®</sup>

OPEN YOUR MIND TO

# THE MODERN REINVENTION OF CLASSIC SHAPES

---

ABRE TU MENTE A

la reinvencción moderna de las  
formas clásicas

ESP

OBRE LA TEVA MENT A

la reinvenció moderna de les  
formes clàssiques

CAT

---

*Principle number 3*

*Our Manifesto*

---



0486

**GRAF BIG**

ALUMINIUM

Designer: Viefe®

**Finishes  
Acabados**

Stainless steel look  
*Inox look*

Brushed dark brass  
*Latón oscuro cepillado*

Brushed black  
*Negro cepillado*

	←→	o — o 1	o — o 2
Stainless steel look <i>Inox look</i>	(∅) 38 mm	-	-
	(∅) 50 mm	-	-
Brushed dark brass <i>Latón oscuro cepillado</i>	224 mm	192 mm	-
	352 mm	320 mm	-
Brushed black <i>Negro cepillado</i>	1200 mm	1168 mm	584 mm



Technical info on page 246  
Info técnica en pág 246



0486

# GRAF BIG

ALUMINIUM

Designer: Viefef®



**Finishes**  
**Acabados**

Stainless steel look  
*Inox look*

Brushed dark brass  
*Latón oscuro cepillado*

Brushed black  
*Negro cepillado*



↳ ←	o — o 1	o — o 2
(Ø) 38 mm	-	-
(Ø) 50 mm	-	-
224 mm	192 mm	-
352 mm	320 mm	-
1200 mm	1168 mm	584 mm



Technical info on page 246  
*Info técnica en pág 246*







0430

# GRAF MINI

ALUMINIUM

Designer: Viefe®

**Finishes**  
**Acabados**

Stainless steel look  
*Inox look*

Brushed dark brass  
*Latón oscuro cepillado*

Brushed black  
*Negro cepillado*

←→	o — o 1	o — o 2
10 mm	-	-
60 mm	-	-
182 mm	160 mm	-
278 mm	256 mm	-
1200 mm	1178 mm	589 mm



Technical info on page 246  
Info técnica en pág 246

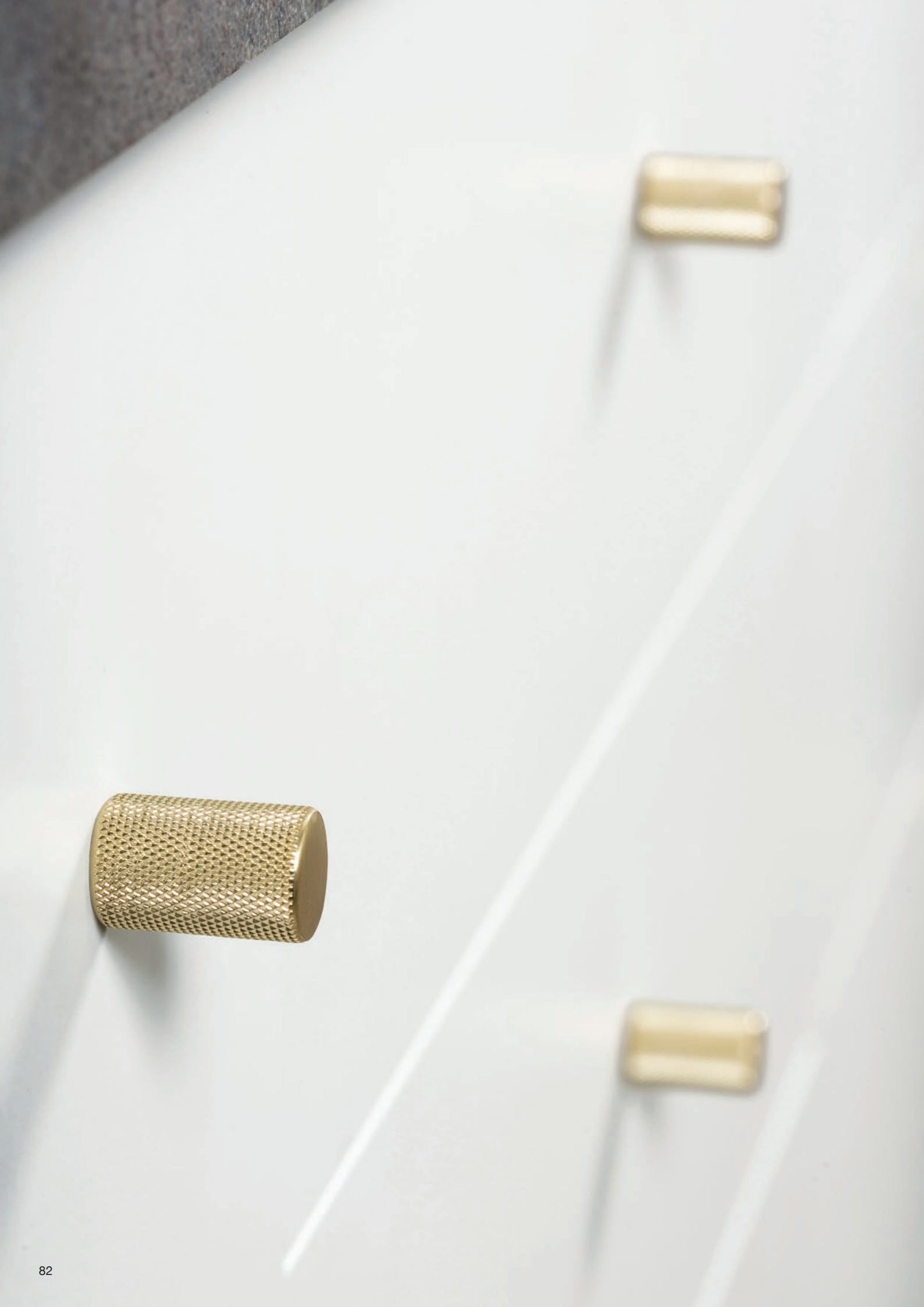

0109

**GRAF**

ALUMINIUM

Designer: Viefef®

**Finishes**  
**Acabados**

Polished chrome  
*Cromo brillo*

Anodized matt  
*Anodizado mate*

Stainless steel look  
*Inox look*

Brushed brass  
*Latón cepillado*

Brushed dark brass  
*Latón oscuro cepillado*

Matt black  
*Negro mate*



17,5 mm



Technical info on page 247  
*Info técnica en pág 247*



0459

# LINES

ZAMAK

Designer: Teruel - Paré

### Finishes Acabados

- Brushed Níquel  
*Níquel cepillado*
- Brushed gold  
*Oro cepillado*
- Brushed mole grey  
*Gris topo cepillado*
- Matt black  
*Negro mate*

← →	o — o
170 mm	160 mm
330 mm	320 mm



⊕  
Technical info on page 242  
Info técnica en pág 242



0467

# SKALA

ALUMINIUM

Designer: Alexis Vivet



## Finishes Acabados

Brushed black  
*Negro cepillado*

Brushed grey  
*Gris cepillado*

Antique bronze  
*Bronce antiguo*

Brushed brass cava  
*Latón cava cepillado*

←→ |

o — o

200 mm

128 mm

350 mm

256 mm



Technical info on page 243  
*Info técnica en pág 243*

0480

NICE

ZAMAK

Designer: Héctor Diego





**Finishes**  
**Acabados**

Brushed Nickel  
*Níquel cepillado*

Brushed gold  
*Oro cepillado*

Brushed mole grey  
*Gris topo cepillado*

Matt black  
*Negro mate*

	
184,6 mm	160 mm
344,6 mm	320 mm

 Technical info on page 244  
*Info técnica en pág 244*

*HÉCTOR DIEGO*

---

# HÉCTOR DIEGO

---

Where:

**Spain**

Designs:

**Nice, Land**

Philosophy:

**Formal correction and proportions**

*Corrección formal y proporciones*

*Correcció formal i proporcions*

 [www.lectordiego.com](http://www.lectordiego.com)

0446

ESTE

ZAMAK

Designer: Balutto Associati



**Finishes**  
**Acabados**

Polished chrome  
*Cromo brillo*

Matt chrome  
*Cromo mate*

Brushed nickel  
*Níquel cepillado*

Brushed copper  
*Cobre cepillado*

Brushed gold  
*Oro cepillado*

Graphite grey  
*Gris grafito*

Matt black  
*Negro mate*

←→ |    o — o  
172 mm    160 mm



Technical info on page 245  
*Info técnica en pág 245*



0447

**BELLA**

ZAMAK

Designer: Balutto Associati

**Finishes**  
**Acabados**

Brushed copper  
*Cobre cepillado*

Brushed gold  
*Oro cepillado*

Graphite grey  
*Gris grafito*

Matt black  
*Negro mate*

←→ |    o — o  
176 mm    160 mm

⊕  
Technical info on page 247  
*Info técnica en pág 247*







0449

# HEXXA

ALUMINIUM + ZAMAK

Designer: Alexis Vivet

**Finishes**  
**Acabados**

←→

Matt white <i>Blanco mate</i>	200 mm 350 mm
Matt black <i>Negro mate</i>	1100 mm 3000 mm
Metallic grey <i>Gris metal</i>	
Metallic brown <i>Marrón metal</i>	

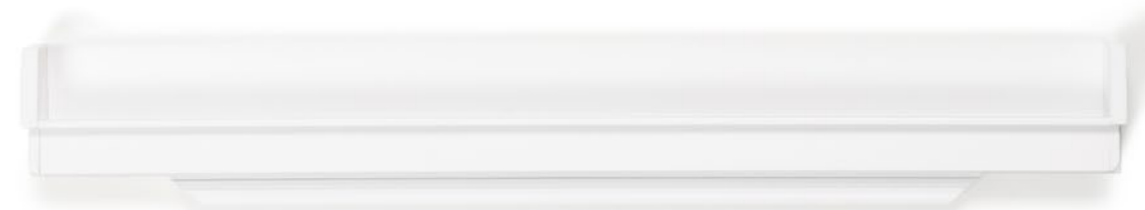

Technical info on page 248  
Info técnica en pág 248

0449

# HEXXA

ALUMINIUM + ZAMAK

Designer: Alexis Vivet

**Finishes**  
**Acabados**

|←→|

Matt white  
*Blanco mate*

200 mm  
350 mm

Matt black  
*Negro mate*

1100 mm  
3000 mm

Metallic grey  
*Gris metal*

Metallic brown  
*Marrón metal*



Technical info on page 248  
*Info técnica en pág 248*





0094

**HIDE**

ZAMAK

Designer: Viefe®



**Finishes**  
**Acabados**

	←→	o — o
Polished chrome <i>Cromo brillo</i>	90 mm 180 mm	64 mm 128 mm
Brushed nickel <i>Níquel cepillado</i>	200 mm	128 mm
<b>NEW!</b> Brushed gold <i>Oro cepillado</i>		
Matt white <i>Blanco mate</i>		
Matt black <i>Negro mate</i>		
Chrome look <i>Cromo look</i>		

⊕  
Technical info on page 248  
Info técnica en pág 248



0119

**WAVE**

ZAMAK

Designer: Viefef®



**Finishes**  
**Acabados**

Polished chrome  
*Cromo brillo*

Brushed nickel  
*Níquel cepillado*

Matt black  
*Negro mate*

←→

45 mm  
173 mm

o — o

32 mm  
160 mm



Technical info on page 249  
*Info técnica en pág 249*

---

# 4.

---

**Viefe**<sup>®</sup>

OPEN YOUR MIND TO

# ACCESSORIES THAT CAN COMPLETELY TRANSFORM FURNITURE

---

ABRE TU MENTE A

complementos que transforman  
por completo un mueble

*ESP*

OBRE LA TEVA MENT A

complements que transformen  
completament un moble

*CAT*

---

*Principle number 4*

*Our Manifesto*

---



0105

(combinable with 0094)

**NEST**

ZAMAK

Designer: Viefef®



**Finishes**  
**Acabados**

Polished chrome  
*Cromo brillo*

Brushed nickel  
*Níquel cepillado*

Polished chrome + White  
*Cromo brillo + Blanco*

Brushed nickel + White  
*Níquel cepillado + Blanco*

*Matt black*  
*Negro mate*

←→	○ — ○
212,5 mm	202,5 mm

⊕  
Technical info on page 249  
*Info técnica en pág 249*



0235

**CLOS**

ZAMAK

Designer: Viefte®



**Finishes**

**Acabados**

Matt white  
*Blanco mate*

Matt black  
*Negro mate*

Polished chrome  
*Cromo brillo*

Brushed nickel  
*Níquel cepillado*



160 mm

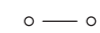

128 mm



Technical info on page 249  
*Info técnica en pág 249*

0366

**CUBIC**

ZAMAK

Designer: Viefef®



**Finishes**  
**Acabados**

Matt white  
*Blanco mate*

Matt black  
*Negro mate*

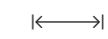

160 mm



Technical info on page 250  
*Info técnica en pág 250*



0073

**TAP**

ZAMAK

Designer: Viefef®



**Finishes**  
**Acabados**

Chrome look  
*Cromo look*

Matt black  
*Negro mate*

∅ 1

35,5 mm

55,3 mm

∅ 2

40 mm

60 mm



Technical info on page 250  
*Info técnica en pág 250*



0301

**SENSE MINI**

ALUMINIUM

Designer: Viefe®



**Finishes**  
**Acabados**

Polished chrome  
*Cromo brillo*

Matt black  
*Negro mate*

Stainless steel look  
*Inox look*

Brushed dark brass  
*Latón oscuro cepillado*

←→	o — o
103 mm	96 mm
167 mm	160 mm
263 mm	256 mm

⊕  
Technical info on page 250  
*Info técnica en pág 250*



0195

**SENSE**

ALUMINIUM

Designer: Viefef®



**Finishes**  
**Acabados**

Polished chrome  
*Cromo brillo*

Stainless steel look  
*Inox look*

Brushed black  
*Negro cepillado*

←→	○ — ○
135 mm	128 mm
199 mm	192 mm
327 mm	320 mm
487 mm	480 mm



Technical info on page 251  
*Info técnica en pág 251*



0451

**FELTRE**

ZAMAK

Designer: Balutto Associati

**Finishes**  
**Acabados**

Brushed nickel  
*Níquel cepillado*

Graphite grey  
*Gris grafito*

Matt black  
*Negro mate*

←→ |    o — o  
218 mm    192 mm



Technical info on page 247  
*Info técnica en pág 247*



Balutto

# BALUTTO ASSOCIATI

Where:

Italy

Designs:

Pura, Round,  
Bol, Bella,  
Este, Feltre,  
Raviolo, Flexa

Philosophy:

Passion for detail  
*Pasión por los detalles*  
*Passió pels detalls*

 [www.baluttoassociati.com](http://www.baluttoassociati.com)

 @baluttoassociati



**Finishes**  
**Acabados**

Polished chrome  
*Cromo brillo*

Stainless steel look  
*Inox look*

Matt white  
*Blanco mate*

Matt black  
*Negro mate*

Metallic grey  
*Gris metal*

Metallic brown  
*Marrón metal*

←→	○ — ○ 1	○ — ○ 2	○ — ○ 3	○ — ○ 4	○ — ○ 5
45 mm	32 mm	-	-	-	-
90 mm	64 mm	-	-	-	-
100 mm	64 mm	-	-	-	-
200 mm	128 mm	160 mm	-	-	-
120 mm	96 mm	-	-	-	-
150 mm	128 mm	-	-	-	-
200 mm	96 mm	128 mm	160 mm	-	-
190 mm	160 mm	-	-	-	-
250 mm	192 mm	-	-	-	-
300 mm	192 mm	-	-	-	-
400 mm	256 mm	-	-	-	-
300 mm	256 mm	-	-	-	-
400 mm	256 mm	320 mm	-	-	-
500 mm	416 mm	-	-	-	-
500 mm	320 mm	416 mm	-	-	-
600 mm	480 mm	-	-	-	-
600 mm	480 mm	512 mm	-	-	256 mm
900 mm	640 mm	-	-	320 mm	-
1480 mm	480 mm	1440	-	-	-

⊕  
Technical info on page 252  
Info técnica en pág 252

0452

**BRAVE**

ALUMINIUM

Designer: Viefef®



**Finishes**  
**Acabados**

Matt white  
*Blanco mate*

Matt black  
*Negro mate*

Metallic grey  
*Gris metal*

Metallic brown  
*Marrón metal*

↳—→	○ — ○ 1	○ — ○ 2
160 mm	128 mm	-
240 mm	192 mm	-
400 mm	320 mm	-
600 mm	192 mm	480 mm
1040 mm	192 mm	992 mm
1150 mm	192 mm	1120 mm



Technical info on page 253  
Info técnica en pág 253

0444

PEAK

ALUMINIUM

Designer: Viefe©



**Finishes**  
**Acabados**

Stainless steel look  
*Inox look*

Brushed black  
*Negro cepillado*

Matt white  
*Blanco mate*

Metallic grey  
*Gris metal*

Metallic brown  
*Marrón metal*

←→	o — o 1	o — o 2
120 mm	64 mm	-
250 mm	192 mm	160 mm
500 mm	448 mm	160 mm
800 mm	768 mm	160 mm
1150 mm	1120 mm	160 mm
1800 mm	1760 mm	160 mm



Technical info on page 254  
info técnica en pág 254





0444

**PEAK**

ALUMINIUM

Designer: Viefef®



**Finishes**  
**Acabados**

Stainless steel look  
*Inox look*

Brushed black  
*Negro cepillado*

Matt white  
*Blanco mate*

Metallic grey  
*Gris metal*

Metallic brown  
*Marrón metal*

	←→	o — o 1	o — o 2
Stainless steel look <i>Inox look</i>	120 mm	64 mm	-
Brushed black <i>Negro cepillado</i>	250 mm	192 mm	160 mm
Matt white <i>Blanco mate</i>	500 mm	448 mm	160 mm
Metallic grey <i>Gris metal</i>	800 mm	768 mm	160 mm
Metallic brown <i>Marrón metal</i>	1150 mm	1120 mm	160 mm
	1800 mm	1760 mm	160 mm



Technical info on page 254  
*Info técnica en pág 254*



0457

**BACKK**

ZAMAK

Designer: Alexis Vivet



**Finishes**  
**Acabados**

Textured black  
*Negro texturizado*

←→	○ — ○ 1	○ — ○ 2
116 mm	96 mm	-
212 mm	192 mm	160 mm



Technical info on page 251  
*Info técnica en pág 251*

---

# 5.

**Viefe**<sup>®</sup>

---

OPEN YOUR MIND TO

# INNOVATIVE MATERIALS WITH A FASHIONABLE FINISH

---

ABRE TU MENTE A  
materiales innovadores con  
acabados de tendencia

*ESP*

OBRE LA TEVA MENT A  
materials innovadors amb  
acabats de tendència

*CAT*

---

*Principle number 5*

*Our Manifesto*

---



0341

**ASI**

ALUMINIUM

Designer: Oriol Barri



**Finishes**  
**Acabados**

Matt black  
*Negro mate*

←→	o — o
146 mm	128 mm
210 mm	192 mm
338 mm	320 mm



Technical info on page 252  
*Info técnica en pág 252*



0465

# STRATT

ALUMINIUM

Designer: Alexis Vivet

**Finishes**

**Acabados**

Anodized matt  
*Anodizado mate*

Matt black  
*Negro mate*

Stainless steel look  
*Inox look*

←→

o — o 1

o — o 2

50 mm

32 mm

-

150 mm

128 mm

-

250 mm

192 mm

-

1100 mm

1056 mm

416 mm



Technical info on page 253  
*Info técnica en pág 253*

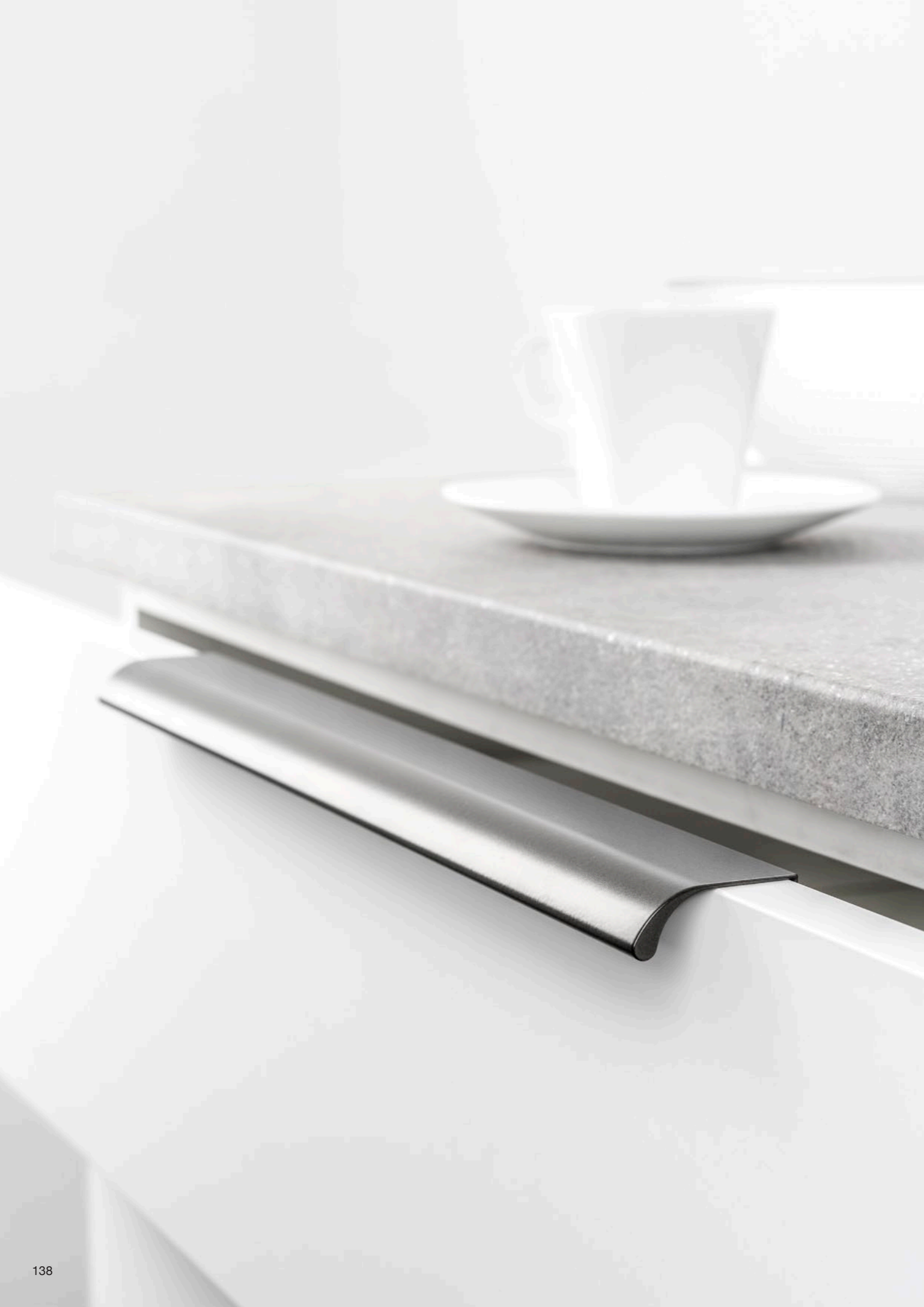

0372

**ONA**

ALUMINIUM

Designer: Teruel-Paré



**Finishes**  
**Acabados**

Stainless steel look  
*Inox look*

Brushed black  
*Negro cepillado*

Brushed grey  
*Gris cepillado*

Matt white  
*Blanco mate*

Metallic grey  
*Gris metal*

Metallic brown  
*Marrón metal*

←→	o — o 1	o — o 2
50 mm	32 mm	-
200 mm	128 mm	-
350 mm	256 mm	-
600 mm	544 mm	-
1100 mm	1056 mm	416 mm
1500 mm	1440 mm	480 mm

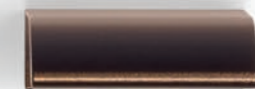

Technical info on page 256  
*Info técnica en pág 256*

**Finishes**  
**Acabados**

 Stainless steel look  
*Inox look*

 Brushed black  
*Negro cepillado*

 Brushed grey  
*Gris cepillado*

 Matt white  
*Blanco mate*

 Metallic grey  
*Gris metal*

 Metallic brown  
*Marrón metal*

|←→|

○ — ○ 1

○ — ○ 2

50 mm

32 mm

-

200 mm

128 mm

-

350 mm

256 mm

-

600 mm

544 mm

-

1100 mm

1056 mm

416 mm

1500 mm

1440 mm

480 mm

 Technical info on page 256  
 Info técnica en pág 256



0375

**VANN**

ALUMINIUM

Designer: Alexis Vivet



**Finishes**  
**Acabados**

Anodized bright  
*Anodizado brillo*

Anodized matt  
*Anodizado mate*

Matt black  
*Negro mate*

Stainless steel look  
*Inox look*

Brushed dark brass  
*Latón oscuro cepillado*

	◀—▶	○ — ○ 1	○ — ○ 2
	100 mm	64 mm	-
	200 mm	128 mm	-
	350 mm	256 mm	-
	1200 mm	1120 mm	384mm

⊕  
Technical info on page 257  
*Info técnica en pág 257*





#### Finishes Acabados

Anodized bright  
*Anodizado brillo*

Anodized matt  
*Anodizado mate*

Matt black  
*Negro mate*

Stainless steel look  
*Inox look*

Brushed dark brass  
*Latón oscuro cepillado*

←→	○ — ○ 1	○ — ○ 2
100 mm	64 mm	-
200 mm	128 mm	-
350 mm	256 mm	-
1200 mm	1120 mm	384mm



Technical info on page 257  
*Info técnica en pág 257*



# ALEXIS VIVET

---

Where:

**Spain**

Designs:

**Wallace, Cutt,  
Brikk, Hexxa,  
Stratt, Vann,  
Nick, Smee,  
Kares, Button,  
Barcco, Skala,  
Backk, Ball**

Philosophy:

**Purism, functionality,  
perfection**

*Purismo, funcionalidad,  
perfección*

*Purisme, funcionalitat,  
perfecció*

---

 [www.alexisvivet.com](http://www.alexisvivet.com)

0117

# CURVE

ALUMINIUM

Designer: Viefe®

## Finishes

### Acabados

Anodized matt  
*Anodizado mate*

Stainless steel look  
*Inox look*

Brushed grey  
*Gris cepillado*

Matt white  
*Blanco mate*

Matt black  
*Negro mate*

←→

o — o

45 mm

32 mm

100 mm

64 mm

200 mm

128 mm

300 mm

192 mm

400 mm

320 mm

500 mm

416 mm



Technical info on page 258  
*Info técnica en pág 258*

0139 / 0140

**LINEAR**

ALUMINIUM

Designer: Viefte®



**Finishes**  
**Acabados**

Stainless steel look  
*Inox look*

Brushed black  
*Negro cepillado*

←→

147 mm

197 mm

247 mm

297 mm

347 mm

397 mm

447 mm

497 mm

597 mm

697 mm

797 mm

897 mm

997 mm

1197 mm



Technical info on page 258  
*Info técnica en pág 258*

0434 / 0435 / 0436

**VECTOR**

ALUMINIUM

Designer: Vief©



**Finishes**  
**Acabados**

Stainless steel look  
*Inox look*

Brushed black  
*Negro cepillado*

Brushed grey  
*Gris cepillado*

←→

147 mm

197 mm

247 mm

297 mm

347 mm

397 mm

447 mm

497 mm

597 mm

697 mm

797 mm

897 mm

997 mm

1197 mm

⊕  
Technical info on page 259  
*Info técnica en pág 259*

0254 / 0255

**NOMA**

ALUMINIUM

Designer: 2J Design



0250 / 0251 / 0253

**FORMA**

ALUMINIUM

Designer: 2J Design



**Finishes**  
**Acabados**

Anodized bright  
*Anodizado brillo*

Stainless steel look  
*Inox look*

Antique bronze  
*Bronce antiguo*

	←→	○ — ○
	200 mm	128 mm
	350 mm	256 mm



Technical info on page 259  
*Info técnica en pág 259*

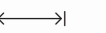

147 mm
197 mm
247 mm
297 mm
347 mm
397 mm
447 mm
497 mm
597 mm
697 mm
797 mm
897 mm
997 mm
1197 mm

**Finishes**  
**Acabados**

Stainless steel look  
*Inox look*



Technical info on page 259  
*Info técnica en pág 259*

0334

**BRIKK**

ALUMINIUM

Designer: Alexis Vivet



**Finishes**  
**Acabados**

	↳←→	○ — ○ 1	○ — ○ 2	○ — ○ 3
140 mm		32 mm	-	-
190 mm		64 mm	-	-
240 mm		96 mm	-	-
290 mm		160 mm	-	-
340 mm		192 mm	-	-
390 mm		128 mm	260 mm	-
440 mm		160 mm	310 mm	-
490 mm		192 mm	360 mm	-
590 mm		224 mm	460 mm	-
690 mm		256 mm	560 mm	-
790 mm		320 mm	660 mm	-
890 mm		384 mm	760 mm	-
990 mm		320 mm	640 mm	860 mm
1190 mm		320 mm	832 mm	1060 mm



Technical info on page 260  
Info técnica en pág 260



0311

**TAMM**

ALUMINIUM

Designer: Alexis Vivet



Finishes Acabados	←→	○ — ○ 1	○ — ○ 1/2	○ — ○ 2	○ — ○ 3
Stainless steel look <i>Inox look</i>	140 mm	32 mm	-	-	-
	190 mm	64 mm	-	-	-
	240 mm	128 mm	-	-	-
	290 mm	160 mm	-	174 mm	-
	340 mm	192 mm	-	224 mm	-
	390 mm	256 mm	128 mm	274 mm	-
	440 mm	256 mm	128 mm	324 mm	-
	490 mm	320 mm	160 mm	374 mm	-
	590 mm	448 mm	224 mm	474 mm	-
	690 mm	512 mm	256 mm	574 mm	-
	790 mm	224 mm	-	608 mm	674 mm
	890 mm	320 mm	-	704 mm	774 mm
	990 mm	320 mm	-	832 mm	874 mm
	1190 mm	384 mm	-	1024 mm	1074 mm



Technical info on page 261  
Info técnica en pág 261

0343

**GRADA**

ALUMINIUM

Designer: Viefef®



Finishes Acabados	←→
Anodized matt <i>Anodizado mate</i>	147 mm 197 mm
Stainless steel look <i>Inox look</i>	247 mm 297 mm
	347 mm 397 mm
Matt white <i>Blanco mate</i>	447 mm 497 mm
	597 mm 697 mm
Matt black <i>Negro mate</i>	797 mm 897 mm
	997 mm 1197 mm
Anodized bright <i>Anodizado brillo</i>	3000 mm



Technical info on page 261  
Info técnica en pág 261



---

# 6.

**Viefe**<sup>®</sup>

---

OPEN YOUR MIND TO

# PROCESSES RESPECTFUL TO BOTH PEOPLE AND THE PLANET

---

ABRE TU MENTE A

procesos respetuosos con las  
personas y con el planeta

*ESP*

OBRE LA TEVA MENT A

processos respectuosos amb les  
persones i amb el planeta

*CAT*

---

*Principle number 6*

*Our Manifesto*

---



0379 / 0380 / 0382

**STEEP**

ALUMINIUM

Designer: Viefe®

**Finishes**  
**Acabados**

Anodized bright  
*Anodizado brillo*

Stainless steel look  
*Inox look*

Matt black  
*Negro mate*

←→

3000 mm



Technical info on page 262  
*Info técnica en pág 262*





0053

**DINO**

ZAMAK

Designer: Viefe®



**Finishes**  
**Acabados**

Polished chrome  
*Cromo brillo*

Brushed nickel  
*Niquel cepillado*

Matt white  
*Blanco mate*

Matt black  
*Negro mate*

Aluminium look  
*Aluminio look*

←→	o — o 1	o — o 2
156 mm	96 mm	128 mm
221 mm	160 mm	192 mm
349 mm	288 mm	320 mm

⊕  
Technical info on page 254  
*Info técnica en pág 254*



0373

**NICK**

ZAMAK

Designer: Alexis Vivet



**Finishes**  
**Acabados**

Polished chrome  
*Cromo brillo*

Brushed nickel  
*Níquel cepillado*

Brushed copper  
*Cobre cepillado*

Brushed brass  
*Latón cepillado*

←→	o — o
50 mm	32 mm
178 mm	160 mm

⊕  
Technical info on page 254  
*Info técnica en pág 254*

0322

**CUTT**

ALUMINIUM

Designer: Alexis Vivet

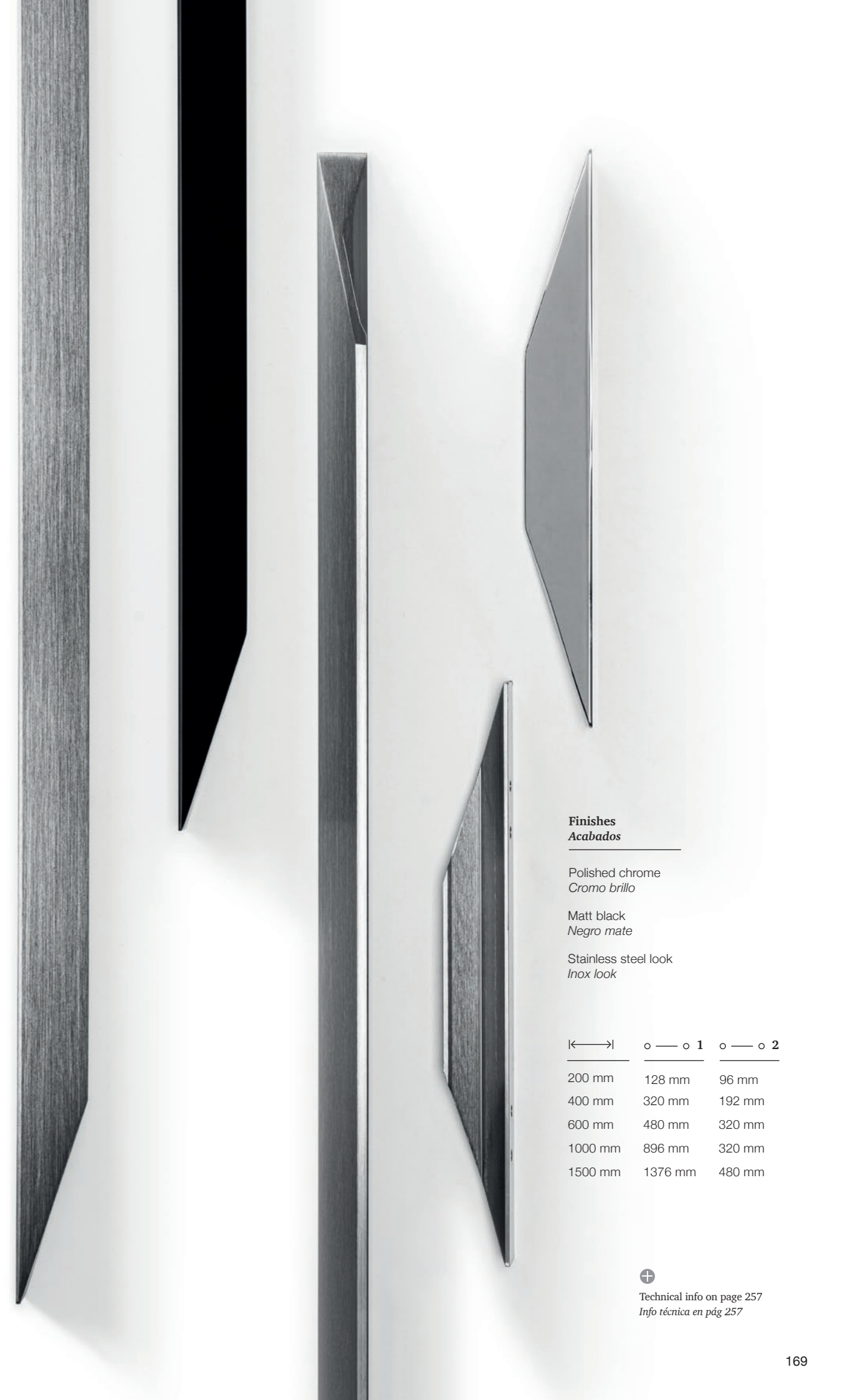

**Finishes**  
**Acabados**

Polished chrome  
*Cromo brillo*

Matt black  
*Negro mate*

Stainless steel look  
*Inox look*

↳→	○ — ○ 1	○ — ○ 2
200 mm	128 mm	96 mm
400 mm	320 mm	192 mm
600 mm	480 mm	320 mm
1000 mm	896 mm	320 mm
1500 mm	1376 mm	480 mm



Technical info on page 257  
*Info técnica en pág 257*

0370

**SMEE**

ZAMAK

Designer: Alexis Vivet



0306

**KARES**

ZAMAK

Designer: Alexis Vivet

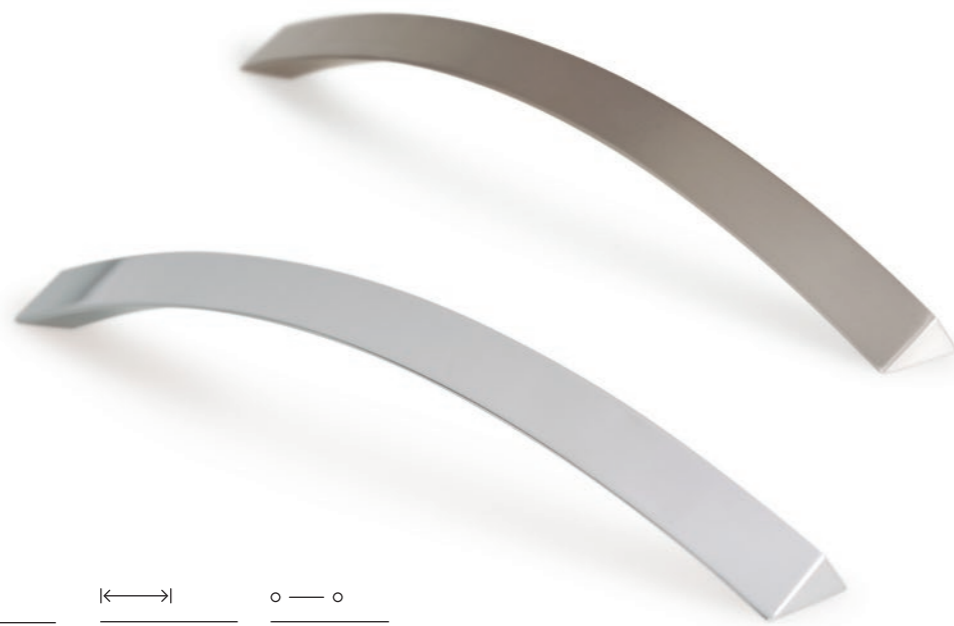
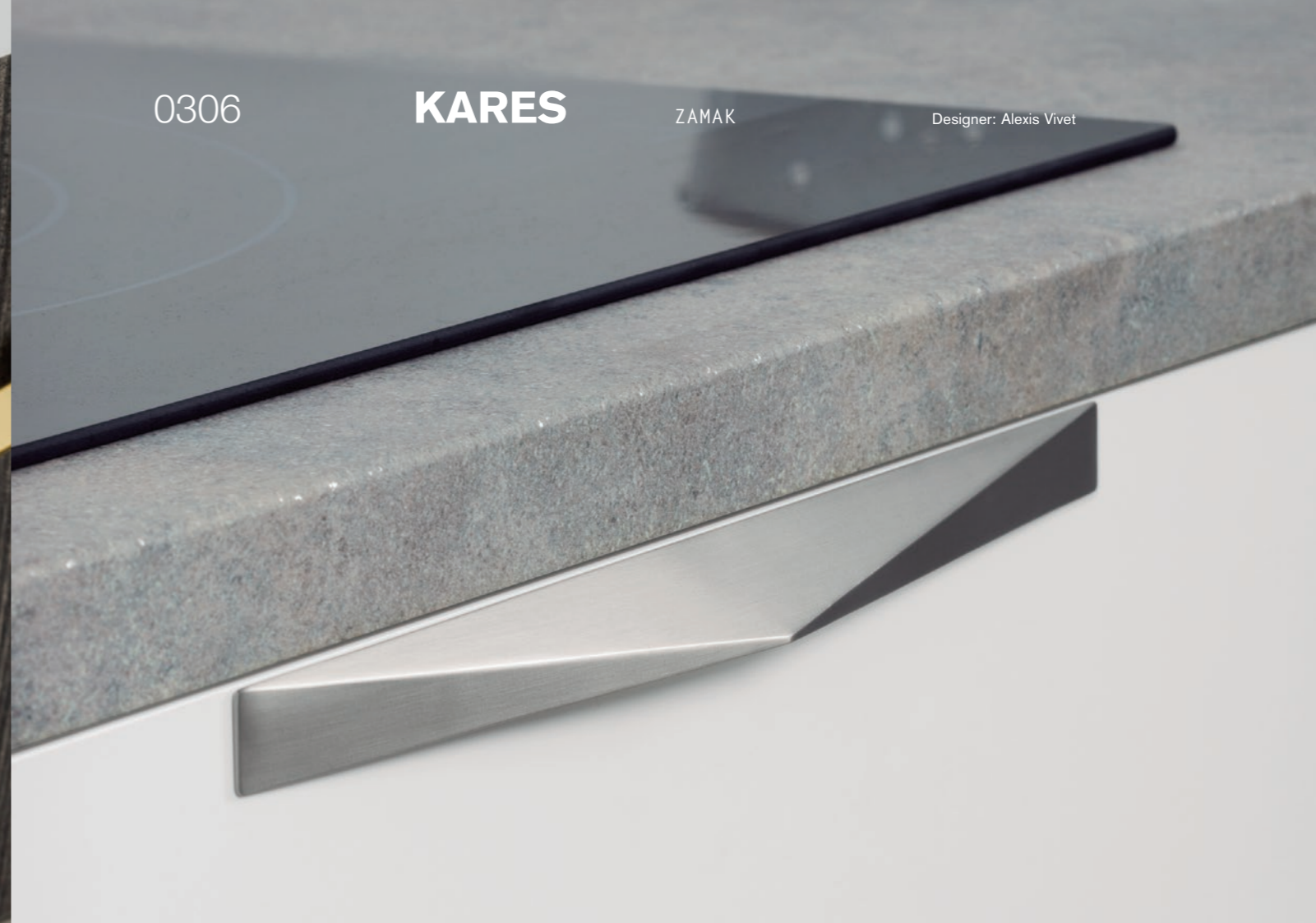

Finishes Acabados	←→	○ — ○
Polished chrome <i>Cromo brillo</i>	166 mm	160 mm
Brushed nickel <i>Níquel cepillado</i>	231 mm	224 mm
Brushed brass <i>Latón cepillado</i>		

⊕  
Technical info on page 255  
Info técnica en pág 255

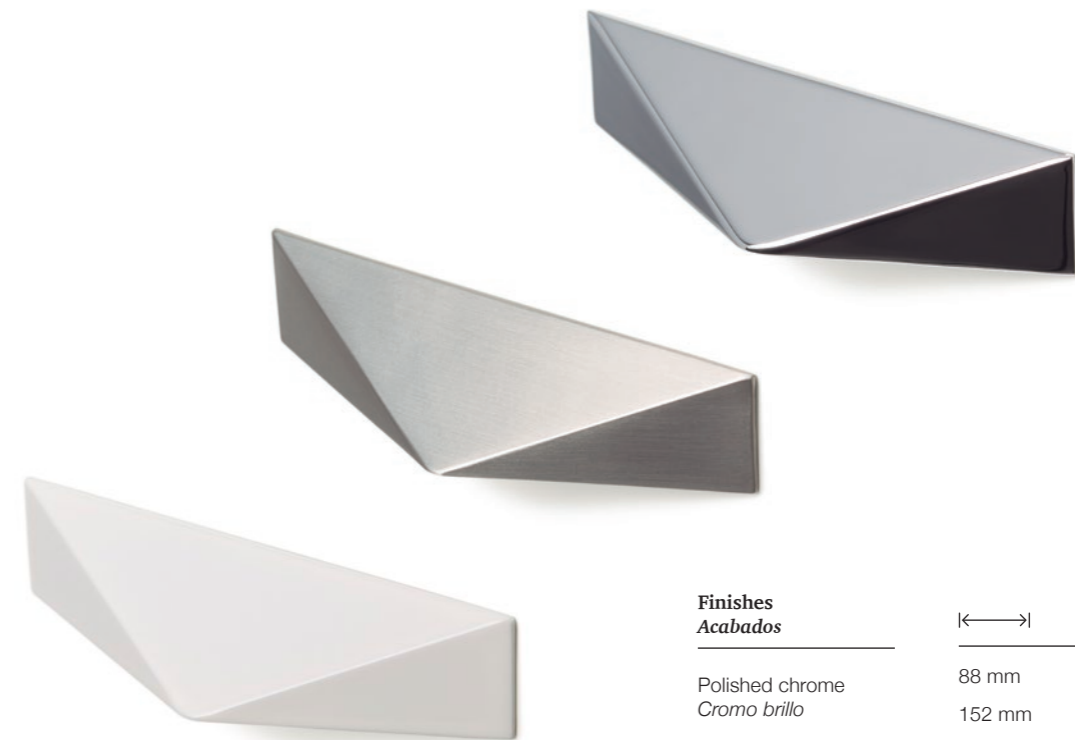

Finishes Acabados	←→	○ — ○
Polished chrome <i>Cromo brillo</i>	88 mm	32 mm
Brushed nickel <i>Níquel cepillado</i>	152 mm	96 mm
Matt white <i>Blanco mate</i>	312 mm	192 mm

⊕  
Technical info on page 255  
Info técnica en pág 255

0206

# ARCH

ZAMAK

Designer: 2J Design



### Finishes Acabados

Polished chrome  
*Cromo brillo*

Brushed nickel  
*Níquel cepillado*



208,5 mm

338,5 mm



192 mm

320 mm



Technical info on page 256  
*Info técnica en pág 256*



0162

# KADO

ZAMAK

Designer: Viefef®



### Finishes Acabados

Polished chrome  
*Cromo brillo*

Brushed nickel  
*Níquel cepillado*



186 mm

346 mm



160 mm

320 mm



Technical info on page 251  
*Info técnica en pág 251*

---

# 7.

**Viefe**<sup>®</sup>

---

OPEN YOUR MIND TO

**HANDLES THAT OPEN  
UP A WORLD OF INFI-  
NITE POSSIBILITIES  
IN DECORATION**

---

ABRE TU MENTE A

tiradores que abren un mundo  
de infinitas posibilidades en decoración

ESP

OBRE LA TEVA MENT A

tiradors que obren un món d'infinites  
possibilitats en decoració

CAT

---

*Principle number 7*

*Our Manifesto*

---





0055

**TWIN**

ALUMINIUM

Designer: Viefte®



**Finishes  
Acabados**

	←→  1	←→  2	○ — ○ 1	○ — ○ 2
Polished chrome <i>Cromo brillo</i>	152 mm	80 mm	128 mm	-
	216 mm	100 mm	192 mm	-
Brushed chrome <i>Cromo cepillado</i>	266 mm	126 mm	224 mm	-
	316 mm	153 mm	256 mm	-
	366 mm	178 mm	288 mm	-
	416 mm	204 mm	256 mm	384 mm
	516 mm	256 mm	288 mm	480 mm
	616 mm	308 mm	352 mm	576 mm
	716 mm	360 mm	480 mm	672 mm



Technical info on page 261  
Info técnica en pág 261

0108

# TWISTED

ZAMAK

Designer: Viefé®



**Finishes**  
**Acabados**

Polished chrome  
*Cromo brillo*

Brushed nickel  
*Níquel cepillado*

←→

170 mm

234 mm

340 mm

o — o

160 mm

224 mm

320 mm



Technical info on page 263  
*Info técnica en pág 263*



0239

# ARA

ALUMINIUM

Designer: 2J Design



**Finishes**  
**Acabados**

Stainless steel look  
*Inox look*

←→

156 mm

252 mm

380 mm

o — o

96 mm

192 mm

320 mm



Technical info on page 263  
*Info técnica en pág 263*

0219

**ARROW**

ZAMAK

Designer: 2J Design



0230

**THIN**

ZAMAK

Designer: 2J Design



**Finishes  
Acabados**

Polished chrome  
*Cromo brillo*

Brushed nickel  
*Níquel cepillado*



223 mm



192 mm



Technical info on page 263  
*Info técnica en pág 263*



**Finishes  
Acabados**

Polished chrome  
*Cromo brillo*

Brushed nickel  
*Níquel cepillado*



96 mm



64 mm

192 mm

160 mm



Technical info on page 264  
*Info técnica en pág 264*



0410

# BUTTON

ZAMAK

Designer: Alexis Vivet



## Finishes

### Acabados

Polished chrome  
Cromo brillo

Pewter  
Peltre

Antique Brass  
Latón antiguo

Matt black  
Negro mate



175 mm

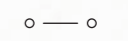

160 mm



Technical info on page 264  
Info técnica en pág 264



0393

**DUKE**

ZAMAK

Designer: Viefef®



**Finishes**  
**Acabados**

Antique copper  
*Cobre antiguo*

Antique silver  
*Plata antigua*

Matt black  
*Negro mate*

Matt white  
*Blanco mate*

Pewter  
*Peltre*

Antique Brass  
*Latón antiguo*

Polished chrome  
*Cromo brillo*

Brushed nickel  
*Níquel cepillado*

Brushed brass  
*Latón cepillado*

Brushed copper  
*Cobre cepillado*



31,4 mm



Technical info on page 264  
*Info técnica en pág 264*

0226

REDO

ZAMAK

Designer: 2J Design

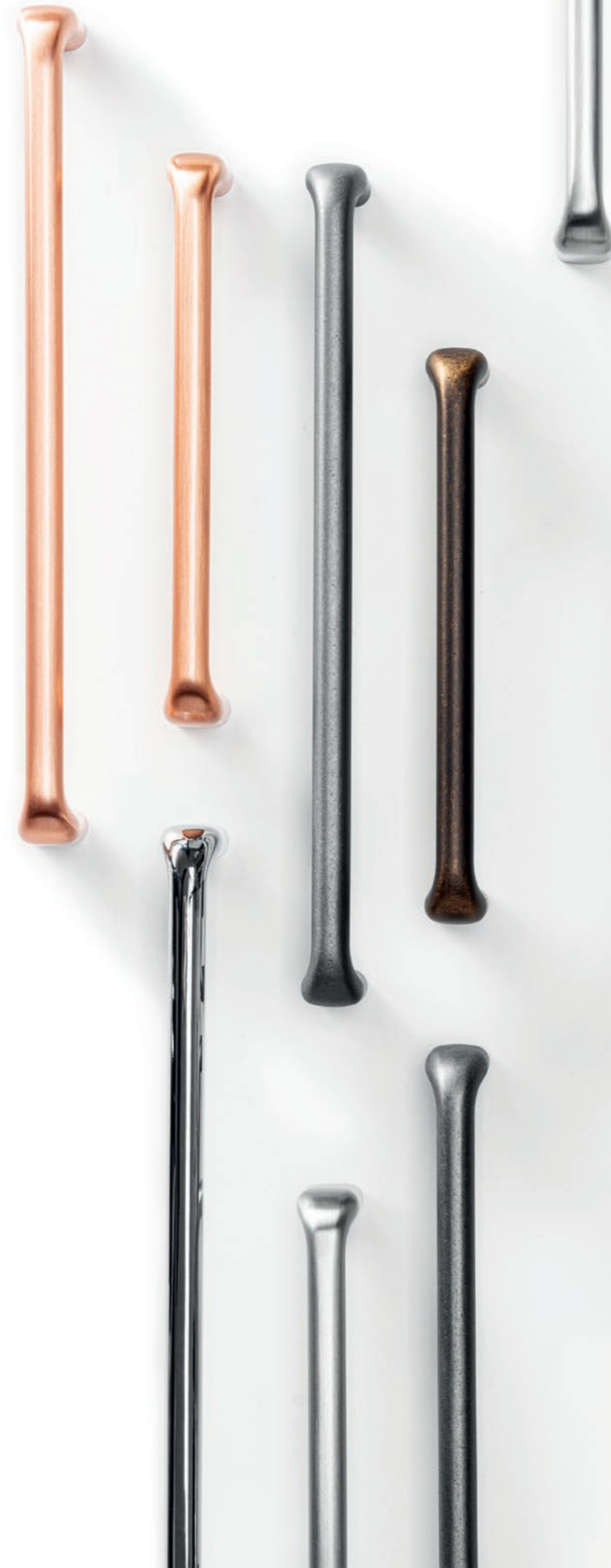

**Finishes**  
**Acabados**

Antique Brass  
*Latón antiguo*

Polished chrome  
*Cromo brillo*

Brushed nickel  
*Níquel cepillado*

Brushed copper  
*Cobre cepillado*

Pewter  
*Peltre*

←→

o — o

137 mm

128 mm

201 mm

192 mm



Technical info on page 265  
*Info técnica en pag 265*



0411

**VERSO**

ZAMAK

Designer: Teruel & Paré



**Finishes**  
**Acabados**

Polished chrome  
*Cromo brillo*

Brushed nickel  
*Níquel cepillado*

Pewter  
*Peltre*

Antique Brass  
*Latón antiguo*

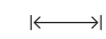

15 mm  
224 mm



-  
192 mm



Technical info on page 265  
*Info técnica en pág 265*

Ignasi Pare

# TERUEL & PARÉ

Where:

Spain

Designs:

Ona, Verso,  
Lines, Ritta,  
Rail

Philosophy:

**Imagination and precision emanating  
from a process of reflection**

*Imaginación y precisión partiendo de la  
reflexión*

*Imaginació i precisió partint de la reflexió*

 [www.ignasipare.com](http://www.ignasipare.com)

 @ignasipare





0405

# RAVIOLO

ZAMAK

Designer: Balutto Associati



**Finishes**  
**Acabados**

Pewter  
Peltre

Antique Brass  
Latón antiguo

← →

Ø 29 mm

172 mm

○ — ○

-

96 mm



Technical info on page 265  
Info técnica en pág 265

0394

AVA

ZAMAK

Designer: Viefte®



0390

PETRA

ZAMAK

Designer: Viefte®



**Finishes**  
**Acabados**

Pewter  
*Peltre*

Antique Brass  
*Latón antiguo*

Polished Chrome  
*Cromo brillo*

←→ |      o — o  
128,5 mm    96 mm



⊕  
Technical info on page 266  
*Info técnica en pág 266*

**Finishes**  
**Acabados**

Antique copper  
*Cobre antiguo*

Antique silver  
*Plata antigua*

Matt black  
*Negro mate*

←→ |      o — o  
97 mm      64 mm

⊕  
Technical info on page 266  
*Info técnica en pág 266*



0392

# ORION

ZAMAK

Designer: Viefel®



**Finishes**  
**Acabados**

Antique copper  
*Cobre antiguo*

Antique silver  
*Plata antigua*



136 mm



128 mm



Technical info on page 266  
*Info técnica en pág 266*

0391

# AURA

ZAMAK

Designer: Viefel®



**Finishes**  
**Acabados**

Antique copper  
*Cobre antiguo*

Antique silver  
*Plata antigua*



87 mm



64 mm



Technical info on page 267  
*Info técnica en pág 267*





**Finishes**  
**Acabados**

Polished chrome + Beige / Brown / Black  
*Cromo brillo + Beige / Marrón / Negro*

Pewter + Beige / Brown / Black  
*Peltre + Beige / Marrón / Negro*

Matt black + Beige / Brown / Black  
*Negro mate + Beige / Marrón / Negro*

Brushed brass + Beige / Brown / Black  
*Latón cepillado + Beige / Marrón / Negro*

←→	○ — ○
70 mm	-
150 mm	128 mm
182 mm	160 mm



⊕  
Technical info on page 267  
*Info técnica en pág 267*

0239

# ARA W

ALUMINIUM + WOOD

Designer: 2J Design



**Finishes**  
**Acabados**

Stainless steel look + Oak  
*Inox look + Roble*

Stainless steel look + Walnut  
*Inox look + Nogal*



220 mm  
284 mm

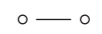

160 mm  
224 mm



Technical info on page 268  
*Info técnica en pág 268*



0340

# BARCCO

WOOD

Designer: Alexis Vivet



### Finishes Acabados

Ash  
*Fresno*

Walnut  
*Nogal*

Beech raw  
*Haya crudo*

K →	o — o 1	o — o 2
200 mm	160 mm	-
400 mm	320 mm	-
600 mm	320 mm	480 mm

⊕  
Technical info on page 268  
Info técnica en pág 268

---

8.

Viefe®

---

OPEN YOUR MIND TO

**DESIGNERS THAT  
LEAVE THEIR MARK  
IN EVERYTHING  
THAT THEY DO**

---

ABRE TU MENTE A

diseñadores que dejan huella en  
todo lo que hacen

ESP

OBRE LA TEVA MENT A

dissenyadors que deixen empremta  
en tot allò que fan

CAT

---

Principle number 8

Viefe's Manifesto

---

0165

# CALIN

WOOD

Designer: Viefefo



0326

# TACCO

WOOD

Designer: Alexis Vivet



## Finishes Acabados

Raw brushed  
*Crudo cepillado*

White brushed  
*Blanco cepillado*

Brown brushed  
*Marrón cepillado*

Black brushed  
*Negro cepillado*

←→ |    o — o  
240 mm    160 mm



⊕  
Technical info on page 268  
*Info técnica en pág 268*

## Finishes Acabados

Ash  
*Fresno*

Walnut  
*Nogal*

Beech raw  
*Haya crudo*

←→ |    o — o  
92,3 mm    32 mm



⊕  
Technical info on page 269  
*Info técnica en pág 269*



0166

# ECHO

WOOD

Designer: Viefef®



### Finishes Acabados

Raw brushed  
Crudo cepillado

White brushed  
Blanco cepillado

Brown brushed  
Marrón cepillado

Black brushed  
Negro cepillado



60 mm



Technical info on page 269  
Info técnica en pág 269

0167

# BALTO

WOOD

Designer: Viefef®



### Finishes Acabados

Raw brushed  
Crudo cepillado

White brushed  
Blanco cepillado

Brown brushed  
Marrón cepillado

Black brushed  
Negro cepillado



60 mm



16 mm



Technical info on page 269  
Info técnica en pág 269



0281

**FLAT**

ZAMAK

Designer: Oriol Barri



**Finishes**  
**Acabados**

Polished chrome  
*Cromo brillo*

Brushed nickel  
*Níquel cepillado*



174,8 mm



160 mm



Technical info on page 270  
*Info técnica en pág 270*

0243 ST

LOW ST

ZAMAK

Designer: Viefte®



**Finishes**  
**Acabados**

Polished chrome  
*Cromo brillo*

Brushed nickel  
*Níquel cepillado*

←→	○ — ○
78 mm	64 mm
206 mm	192 mm

⊕  
Technical info on page 270  
*Info técnica en pág 270*

0204

RADI

STAINLESS STEEL

Designer: Viefte®



**Finishes**  
**Acabados**

Brushed stainless steel  
*Inox cepillado*



50 mm  
65 mm

⊕  
Technical info on page 270  
*Info técnica en pág 270*

0091

# RASO

ZAMAK

Designer: Viefef®



### Finishes Acabados

Polished chrome  
*Cromo brillo*

Brushed nickel  
*Níquel cepillado*



70 mm

152,5 mm



32 mm

108 mm



Technical info on page 271  
*Info técnica en pág 271*

0208

# DUA

ZAMAK

Designer: 2J Design



### Finishes Acabados

Polished chrome  
*Cromo brillo*

Brushed nickel  
*Níquel cepillado*

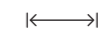

210 mm



192 mm



Technical info on page 271  
*Info técnica en pág 271*



0376

**BOXX**

ZAMAK

Designer: Alexis Vivet



**Finishes**  
**Acabados**

Polished chrome  
*Cromo brillo*

Matt chrome  
*Cromo mate*

Brushed nickel  
*Níquel cepillado*

Matt black  
*Negro mate*



15 mm



Technical info on page 271  
*Info técnica en pág 271*

0097

# BIN

ALUMINIUM

Designer: 2J Design



### Finishes Acabados

Polished chrome  
*Cromo brillo*

Brushed chrome  
*Cromo cepillado*



15 mm

20 mm



Technical info on page 272  
*Info técnica en pág 272*

0065

# SQUARE

ZAMAK

Designer: Viefef®



### Finishes Acabados

Polished chrome  
*Cromo brillo*

Matt chrome  
*Cromo mate*

Brushed nickel  
*Níquel cepillado*



44 mm



16 mm



Technical info on page 272  
*Info técnica en pág 272*



0374

# BALL

ZAMAK

Designer: Alexis Vivet



### Finishes Acabados

Polished chrome  
*Cobre brillo*

Brushed nickel  
*Níquel cepillado*

Brushed brass  
*Latón cepillado*



23,3 mm  
29,5 mm



Technical info on page 272  
*Info técnica en pág 272*

0009

# PISTON

ZAMAK + ACRYLIC

Designer: 2J Design



### Finishes Acabados

Brushed nickel + White  
*Níquel cepillado + Blanco*

Brushed nickel + Black  
*Níquel cepillado + Negro*



34,5 mm



Technical info on page 273  
*Info técnica en pág 273*



0113

# FRUIT

ZAMAK + ACRYLIC

Designer: 2J Design



### Finishes Acabados

Polished chrome +  
White / Black / Lime

*Cromo brillo +  
Blanco / Negro / Lima*

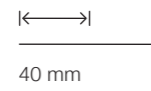

Technical info on page 273  
Info técnica en pág 273



0129

# BLOK

ZAMAK + ACRYLIC

Designer: Viefef®



### Finishes Acabados

Brushed nickel + Matt white  
*Níquel cepillado + Blanco mate*

Brushed nickel + Matt black  
*Níquel cepillado + Negro mate*

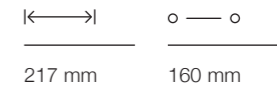

Technical info on page 273  
Info técnica en pág 273







# 2J DESIGN

---

Where:

**USA**

Designs:

**Arch, Redo, Piston, Thin,  
Arrow, Hook, Acer, Dua,  
Forma, Roma, Fruit, Ara,  
Noma, Bin, Ara W**

Philosophy:

**Realistic creativity**  
*Creatividad realista*  
*Creativitat realista*

---

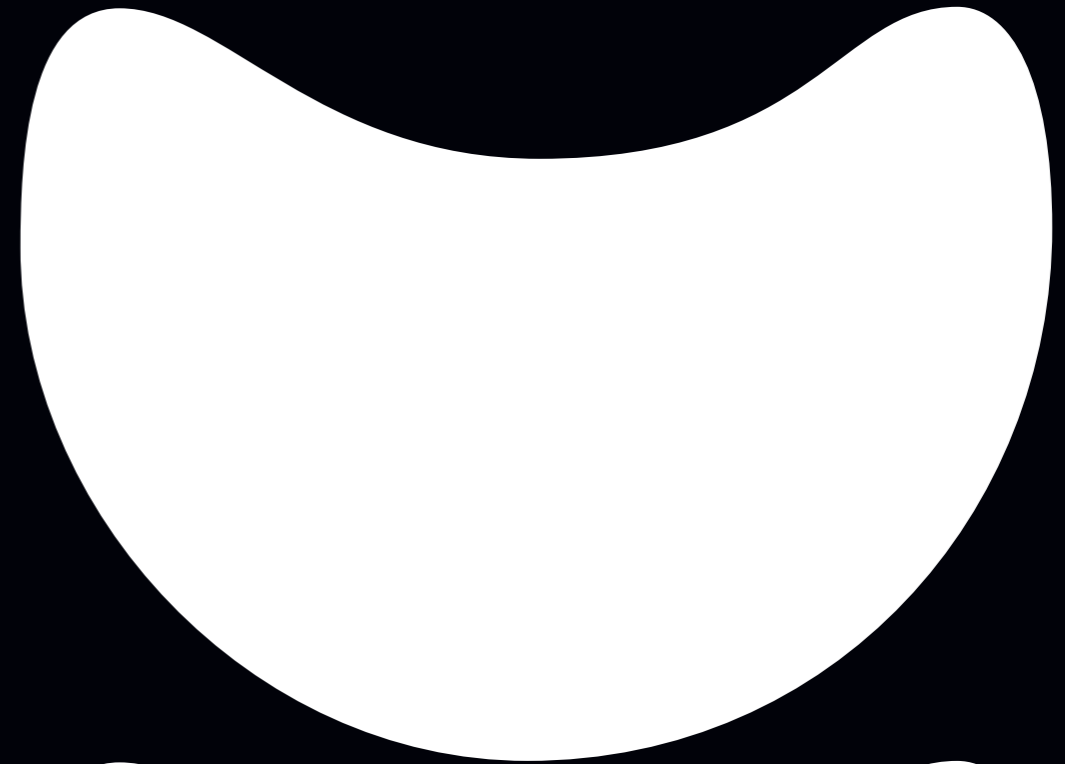

0369

**RITTA**

ALUMINIUM

Designer: Teruel-Paré



**Finishes**  
**Acabados**

Polished chrome  
*Cromo brillo*

Matt black  
*Negro mate*

Stainless steel look  
*Inox look*

←→	○ — ○
130 mm	64 mm
260 mm	128 mm

⊕  
Technical info on page 274  
*Info técnica en pág 274*

0092

**GLASS**

ZAMAK + GLASS

Designer: Viefie®



**Finishes**  
**Acabados**

Polished chrome + Tempered glass  
*Cromo brillo + Cristal temperado*

←→	○ — ○
30 mm	-
175 mm	160 mm
207 mm	192 mm
335 mm	320 mm

⊕  
Technical info on page 274  
*Info técnica en pág 274*

0249

**FERRI**

STAINLESS STEEL

Designer: Viefie®



**Finishes**  
**Acabados**

Brushed stainless steel  
*Acero inoxidable cepillado*

Polished stainless steel  
*Acero inoxidable brillo*

←→	○ — ○
140 mm	128 mm
172 mm	160 mm
204 mm	192 mm
332 mm	320 mm
524 mm	512 mm

⊕  
Technical info on page 274  
*Info técnica en pág 274*

0076

**FORT**

STAINLESS STEEL

Designer: Viefie®

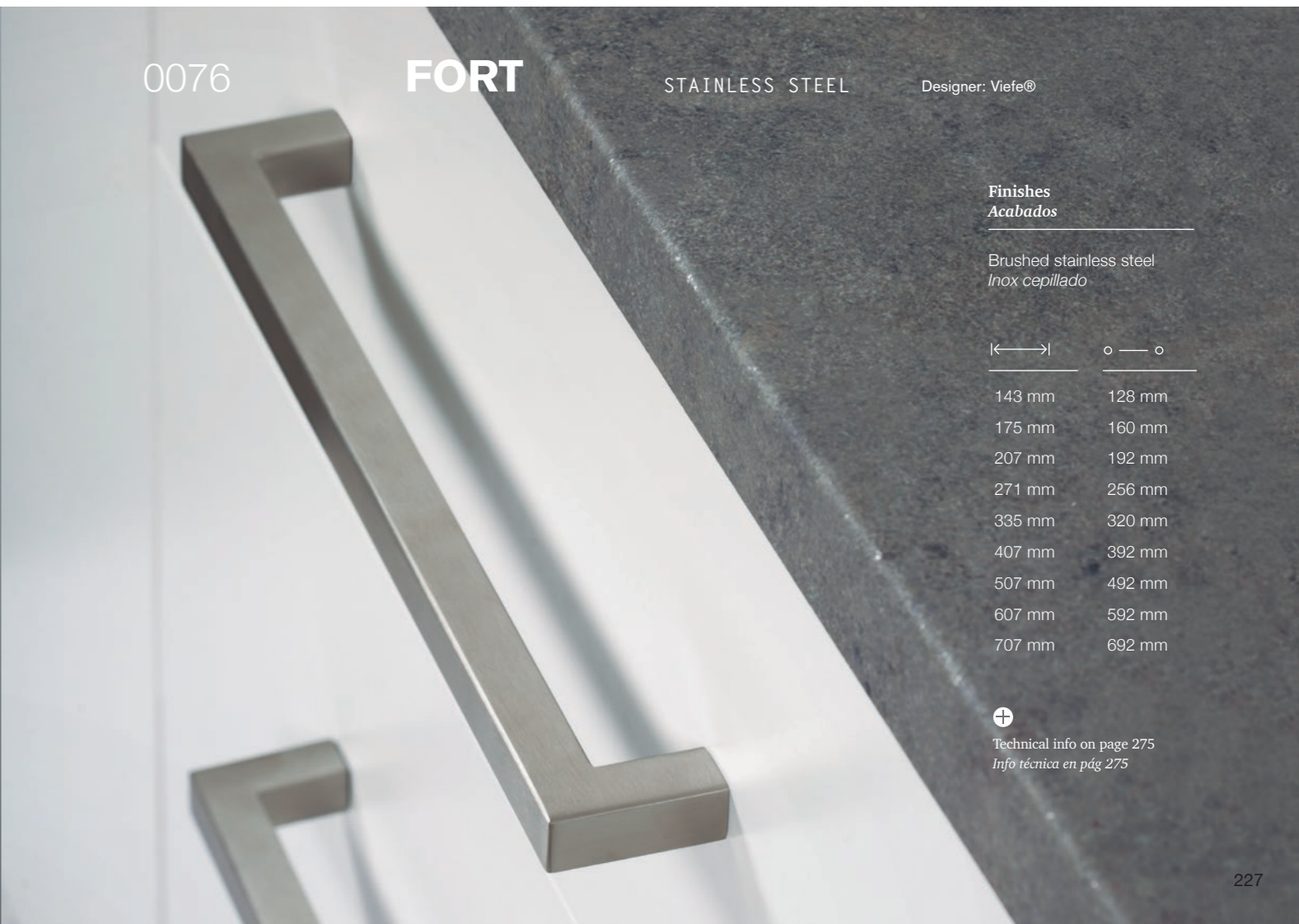

**Finishes**  
**Acabados**

Brushed stainless steel  
*Inox cepillado*

←→	○ — ○
143 mm	128 mm
175 mm	160 mm
207 mm	192 mm
271 mm	256 mm
335 mm	320 mm
407 mm	392 mm
507 mm	492 mm
607 mm	592 mm
707 mm	692 mm

⊕  
Technical info on page 275  
*Info técnica en pág 275*

0083

**TUB**

STAINLESS STEEL

Design: Viefte®



Finishes Acabados	←→	○ — ○
Brushed stainless steel <i>Inox cepillado</i>	192 mm	128 mm
	224 mm	160 mm
	256 mm	192 mm

⊕  
Technical info on page 275  
Info técnica en pág 275

0064

**KOMBI**

STAINLESS STEEL

Designer: Viefte®



Finishes Acabados	←→	○ — ○
Brushed stainless steel <i>Inox cepillado</i>	182 mm	160 mm
	214 mm	192 mm
	314 mm	292 mm
	364 mm	342 mm
	414 mm	392 mm
	514 mm	492 mm
	814 mm	792 mm
	1114 mm	1092 mm

⊕  
Technical info on page 276  
Info técnica en pág 276

0312

**ARKO**

ALUMINIUM

Designer: Viefte®



Finishes Acabados	←→	○ — ○
Stainless steel look <i>Inox look</i>	186 mm	160 mm
	218 mm	192 mm
	292 mm	256 mm

⊕  
Technical info on page 275  
Info técnica en pág 275

0060

**STEP**

ALUMINIUM

Designer: Viefte®



Finishes Acabados	←→	○ — ○ 1	○ — ○ 2
Polished chrome <i>Cromo brillo</i>	80 mm	32 mm	-
	150 mm	96 mm	-
	250 mm	160 mm	-
	350 mm	224 mm	-
	550 mm	480 mm	240 mm

⊕  
Technical info on page 276  
Info técnica en pág 276

0315

# ZAPA

ZAMAK

Designer: Oriol Barri



### Finishes Acabados

Polished chrome  
*Cromo brillo*

Matt chrome  
*Cromo mate*

Brushed nickel  
*Níquel cepillado*



45 mm



Technical info on page 276  
*Info técnica en pág 276*

0169

# ONE

ZAMAK

Designer: Viefie®



### Finishes Acabados

Polished chrome  
*Cromo brillo*

Matt chrome  
*Cromo mate*

Brushed nickel  
*Níquel cepillado*



15 mm



Technical info on page 277  
*Info técnica en pág 277*

0114

# HOOK

ZAMAK

Designer: 2J Design



### Finishes Acabados

Polished chrome  
*Cromo brillo*

Brushed nickel  
*Níquel cepillado*



30 mm

Includes non-twisting tip  
*Incluye punta anti-giro*



Technical info on page 277  
*Info técnica en pág 277*

0035

# ACER

STAINLESS STEEL

Designer: 2J Design



### Finishes Acabados

Brushed stainless steel  
*Inox cepillado*



18 mm

23 mm

28 mm



Technical info on page 277  
*Info técnica en pág 277*

6003

**JAZZ**

ALUMINIUM

Designer: Viefe®

**Finishes**  
**Acabados**

Polished chrome  
*Cromo brillo*

Chrome look  
*Cromo look*



91 mm



Technical info on page 278  
*Info técnica en pág 278*

# TECHNICAL INFO

References  
Sizes  
Measurements  
Finishes  
Technical drawings

Referencias  
Tallas  
Medidas  
Acabados  
Dibujos técnicos

Referències  
Talles  
Mides  
Acabats  
Dibuixos tècnics

0495 **FLOID** ZAMAK Design: Frank Person **NEW!**

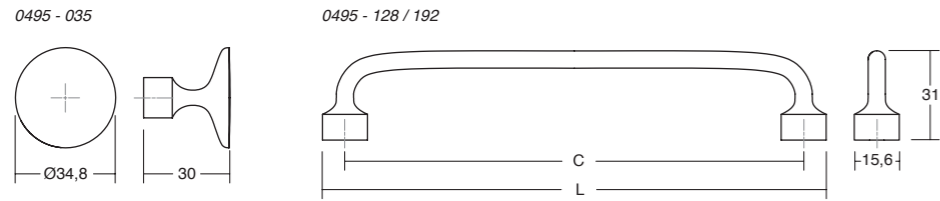

28	610	614	M2	C	L	↓	☐
Brushed gold Oro cepillado	Pewter Peltre	Antique brass Latón antiguo	Matt black Negro mate				
0495035Z28	0495035Z610	0495035Z614	0495035ZM2	-	-	1	25
0495128Z28	0495128Z610	0495128Z614	0495128ZM2	128	143,6	2	25
0495192Z28	0495192Z610	0495192Z614	0495192ZM2	192	207,6	2	25



0496 **BAU** ZAMAK Design: Patricia Roig **NEW!**

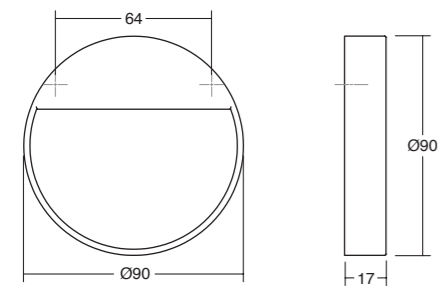

23	28	M2	↓	☐
Brushed nickel Níquel cepillado	Brushed gold Oro cepillado	Matt black Negro mate		
0496064Z23	0496064Z28	0496064ZM2	2	25

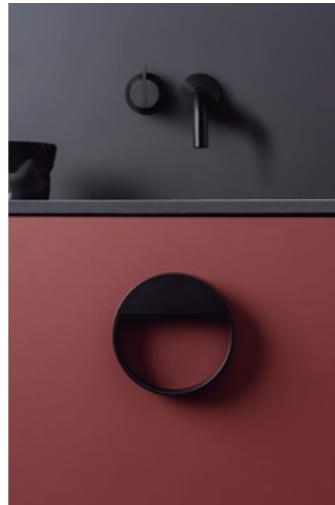

0487 **PURA** ZAMAK Design: Balutto Associati **NEW!**

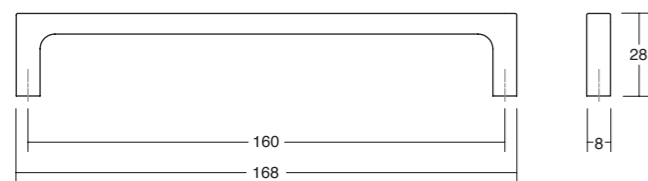

01	03	06	07	↓	☐
Polished chrome Cromo brillo	Polished black nickel Nickel negro brillo	Polished copper Cobre brillo	Polished brass Latón brillo		
0487160Z01	0487160Z03	0487160Z06	0487160Z07	2	25



0127 **JEY** ALUMINIUM Design: Viefé®

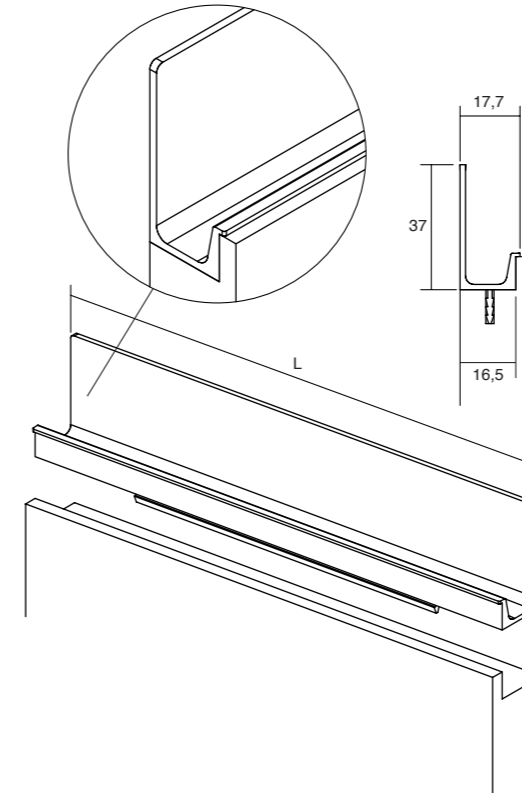

24	618 NEW!	M1	M2	L	☐
Stainless steel look Inox look	Brushed brass cava Latón cava cepillado	Matt white Blanco mate	Matt black Negro mate		
0127147L24	0127147L618	0127147LM1	0127147LM2	147	15
0127197L24	0127197L618	0127197LM1	0127197LM2	197	15
0127247L24	0127247L618	0127247LM1	0127247LM2	247	15
0127297L24	0127297L618	0127297LM1	0127297LM2	297	15
0127347L24	0127347L618	0127347LM1	0127347LM2	347	15
0127397L24	0127397L618	0127397LM1	0127397LM2	397	15
0127447L24	0127447L618	0127447LM1	0127447LM2	447	10
0127497L24	0127497L618	0127497LM1	0127497LM2	497	10
0127597L24	0127597L618	0127597LM1	0127597LM2	597	10
0127697L24	0127697L618	0127697LM1	0127697LM2	697	10
0127797L24	0127797L618	0127797LM1	0127797LM2	797	10
0127897L24	0127897L618	0127897LM1	0127897LM2	897	5
0127997L24	0127997L618	0127997LM1	0127997LM2	997	5
01271197L24	01271197L618	01271197LM1	01271197LM2	1197	5
-	-	01273000LM1	01273000LM2	3000	15 *

\* Available only in M1 and M2 finishes / Disponible solo en los acabados M1 y M2

0163 **JEY2** ALUMINIUM Design: Viefé®

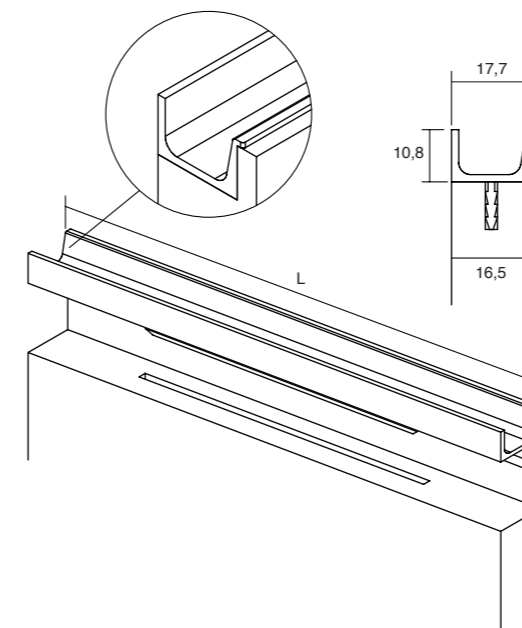

24	618 NEW!	M1	M2	L	☐
Stainless steel look Inox look	Brushed brass cava Latón cava cepillado	Matt white Blanco mate	Matt black Negro mate		
0163147L24	0163147L618	0163147LM1	0163147LM2	147	15
0163197L24	0163197L618	0163197LM1	0163197LM2	197	15
0163247L24	0163247L618	0163247LM1	0163247LM2	247	15
0163297L24	0163297L618	0163297LM1	0163297LM2	297	15
0163347L24	0163347L618	0163347LM1	0163347LM2	347	15
0163397L24	0163397L618	0163397LM1	0163397LM2	397	15
0163447L24	0163447L618	0163447LM1	0163447LM2	447	10
0163497L24	0163497L618	0163497LM1	0163497LM2	497	10
0163597L24	0163597L618	0163597LM1	0163597LM2	597	10
0163697L24	0163697L618	0163697LM1	0163697LM2	697	10
0163797L24	0163797L618	0163797LM1	0163797LM2	797	10
0163897L24	0163897L618	0163897LM1	0163897LM2	897	5
0163997L24	0163997L618	0163997LM1	0163997LM2	997	5
01631197L24	01631197L618	01631197LM1	01631197LM2	1197	5
-	-	01633000LM1	01633000LM2	3000	15 *

\* Available only in M1 and M2 finishes / Disponible solo en los acabados M1 y M2

0168 **COMO** ZAMAK Design: Viefef®

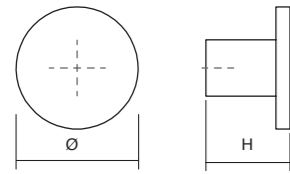

01	03 <b>NEW!</b>	06 <b>NEW!</b>	07 <b>NEW!</b>	11	23	26	28	M1	M2	Ø	H	↓	📦
Polished chrome	Polished black nickel	Polished copper	Polished brass	Matt chrome	Brushed nickel	Brushed copper	Brushed gold	Matt white	Matt black				
<i>Cromo brillo</i>	<i>Níquel negro brillo</i>	<i>Cobre brillo</i>	<i>Latón brillo</i>	<i>Cromo mate</i>	<i>Níquel cepillado</i>	<i>Cobre cepillado</i>	<i>Oro cepillado</i>	<i>Blanco mate</i>	<i>Negro mate</i>				
0168026Z01	0168026Z03	0168026Z06	0168026Z07	0168026Z11	0168026Z23	0168026Z26	0168026Z28	0168026ZM1	0168026ZM2	26	18	1	25
0168041Z01	0168041Z03	0168041Z06	0168041Z07	0168041Z11	0168041Z23	0168041Z26	0168041Z28	0168041ZM1	0168041ZM2	41	25	1	25

0490 **SWITCH** ZAMAK Design: Viefef® **NEW!**

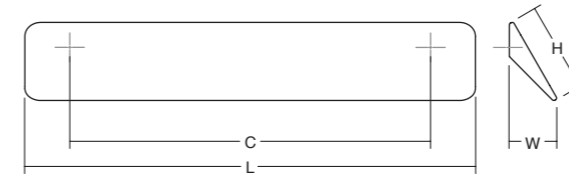

23	M1	M2	C	L	H	W	↓	📦
Brushed nickel	Matt white	Matt black						
<i>Níquel cepillado</i>	<i>Blanco mate</i>	<i>Negro mate</i>						
0490032Z23	0490032ZM1	0490032ZM2	32	50	50	26,4	2	25
0490160Z23	0490160ZM1	0490160ZM2	160	200	40	21,3	2	25

0518 **WAY** ALUMINIUM Design: Viefef® **NEW!**



0497 **DIABOLO** ALUMINIUM Design: Frank Person **NEW!**

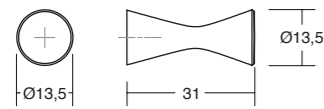

24	291	30	31	↓	📦
Stainless steel look	Brushed dark brass	Brushed black	Brushed grey		
<i>Inox look</i>	<i>Latón oscuro cepillado</i>	<i>Negro cepillado</i>	<i>Gris cepillado</i>		
0497014L24	0497014L291	0497014L30	0497014L31	1	25

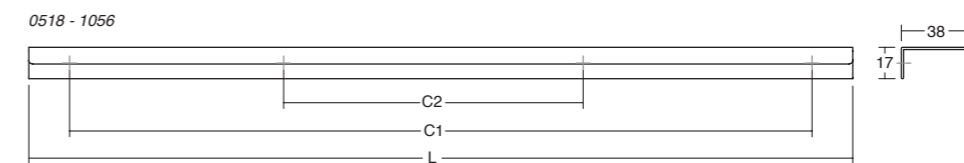
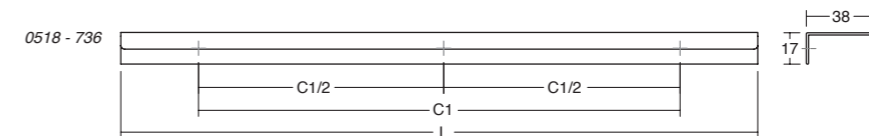
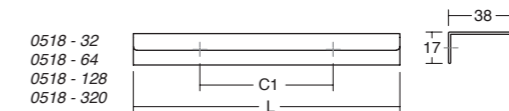

0499 **ROUND** ALUMINIUM Design: Balutto Associati **NEW!**

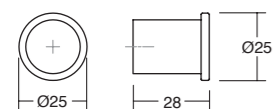

24	291	30	↓	📦
Stainless steel look	Brush dark brass	Brushed black		
<i>Inox look</i>	<i>Latón oscuro cepillado</i>	<i>Negro cepillado</i>		
0499025L24	0499025L291	0499025L30	1	25

04	09	24	29	M1	C1	C1/2	C2	L	↓	📦
Anodized matt	Matt black	Stainless steel look	Brushed dark brass	Matt White						
<i>Anodizado mate</i>	<i>Negro mate</i>	<i>Inox look</i>	<i>Latón oscuro cepillado</i>	<i>Blanco mate</i>						
0518032L04	0518032L09	0518032L24	0518032L29	0518032LM1	32	-	-	50	2	25
0518064L04	0518064L09	0518064L24	0518064L29	0518064LM1	64	-	-	100	2	25
0518128L04	0518128L09	0518128L24	0518128L29	0518128LM1	128	-	-	200	2	25
0518320L04	0518320L09	0518320L24	0518320L29	0518320LM1	320	-	-	400	2	25
0518736L04	0518736L09	0518736L24	0518736L29	0518736LM1	736	368	-	800	3	25
05181056L04	05181056L09	05181056L24	05181056L29	05181056LM1	1056	-	352	1100	4	15



0511 **RAIL** ALUMINIUM Design: Teruel - Paré **NEW!**

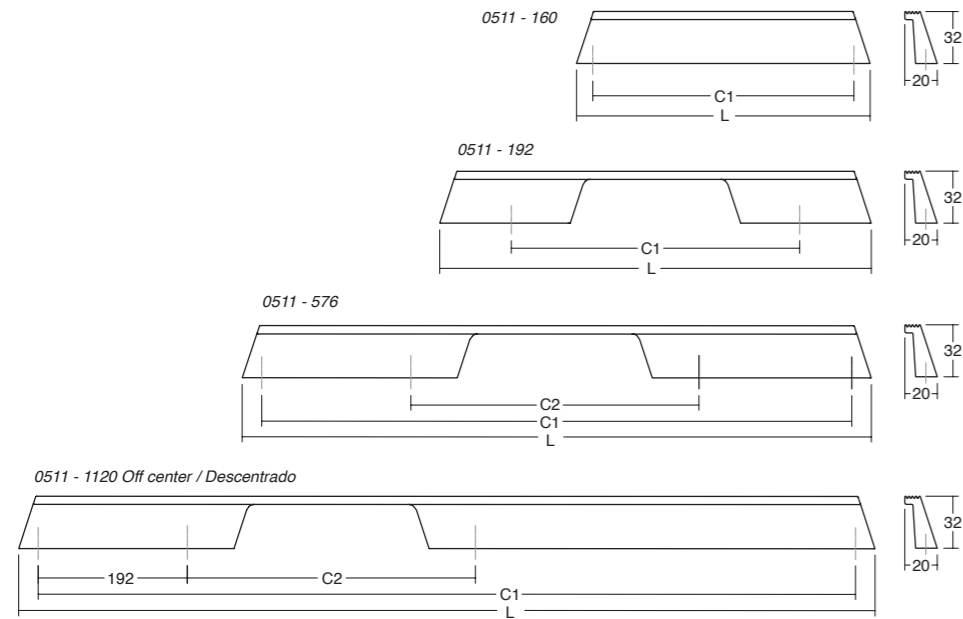

24	30	618	C1	C2	L	↓	☐
Stainless steel look Inox look	Brushed black Negro cepillado	Brushed brass cava Latón cava cepillado					
0511160L24	0511160L30	0511160L618	160	-	180	2	25
0511192L24	0511192L30	0511192L618	192	-	280	2	25
0511576L24	0511576L30	0511576L618	576	192	600	4	15
05111120L24	05111120L30	05111120L618	1120	192	1150	4	15

Off-center  
Descentrado

0241 **ROMA** ZAMAK Design: 2J Design

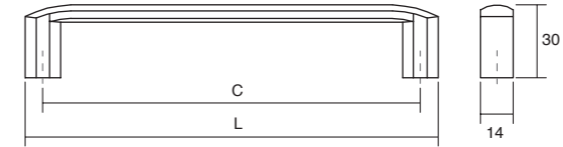

01	23	28 <b>NEW!</b>	M2 <b>NEW!</b>	C	L	↓	☐
Polished chrome Cromo brillo	Brushed nickel Níquel cepillado	Brushed gold Oro cepillado	Matt black Negro mate				
0241160Z01	0241160Z23	0241160Z28	0241160ZM2	160	175	2	25
0241192Z01	0241192Z23	0241192Z28	0241192ZM2	192	207	2	25
0241320Z01	0241320Z23	0241320Z28	0241320ZM2	320	335	2	25

0503 **WALLACE** ZAMAK Design: Alexis Vivet **NEW!**

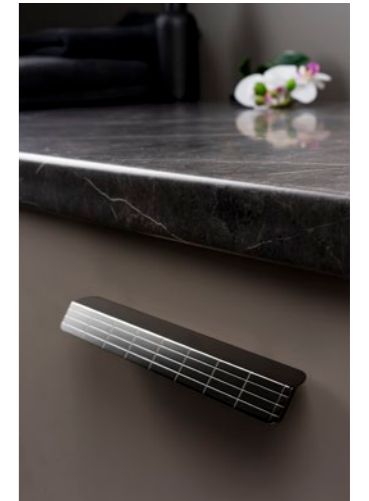
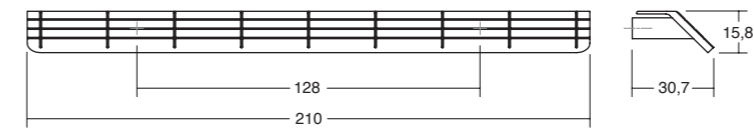

01	03	06	07	↓	☐
Polished chrome Cromo brillo	Polished black nickel Níquel negro brillo	Polished copper Cobre brillo	Polished brass Latón brillo		
0503128Z01	0503128Z03	0503128Z06	0503128Z07	2	25

0056 **U** ZAMAK Design: Viefé®

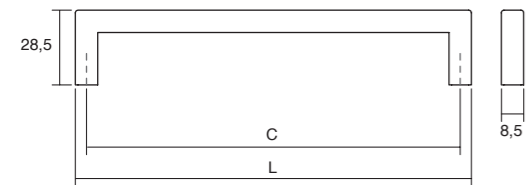

01	11	23	26	27	31	M1 <b>NEW!</b>	M2	C	L	↓	☐
Polished chrome Cromo brillo	Matt chrome Cromo mate	Brushed nickel Níquel cepillado	Brushed copper Cobre cepillado	Brushed brass Latón cepillado	Brushed grey Gris cepillado	Matt white Blanco mate	Matt black Negro mate				
0056128Z01	0056128Z11	0056128Z23	0056128Z26	0056128Z27	0056128Z31	0056128ZM1	0056128ZM2	128	136,5	2	25
0056160Z01	0056160Z11	0056160Z23	0056160Z26	0056160Z27	0056160Z31	0056160ZM1	0056160ZM2	160	168,5	2	25
0056192Z01	0056192Z11	0056192Z23	0056192Z26	0056192Z27	0056192Z31	0056192ZM1	0056192ZM2	192	200,5	2	25
0056320Z01	0056320Z11	0056320Z23	0056320Z26	0056320Z27	0056320Z31	0056320ZM1	0056320ZM2	320	328,5	2	25
0056492Z01	0056492Z11	0056492Z23	0056492Z26	0056492Z27	0056492Z31	0056492ZM1	0056492ZM2	492	500,5	2	25

0489 **BOL** ZAMAK / WOOD Design: Balutto Associati **NEW!**

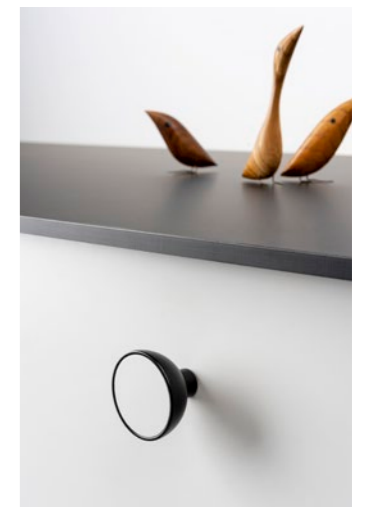
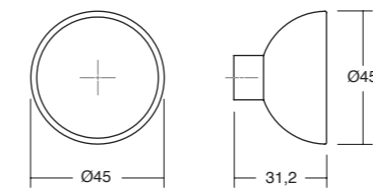

M2+22	M2+23	M2+M1	↓	☐
M2 Matt black + Sapelli Negro mate + Sapelli	M2 Matt black + Beech Negro mate + Haya	M2 Matt black + Matt white lacquered Negro mate + Lacado blanco mate		
0489045NM222	0489045NM223	0489045NM2M1	1	25

0507 **OBLONG** LEATHER / ZAMAK Design: Frank Person **NEW!**

0507 - 160

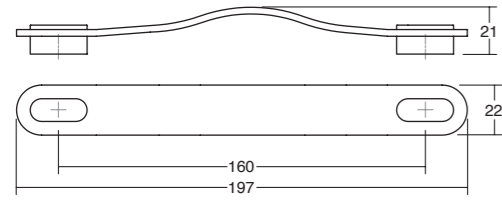

0507 - 070

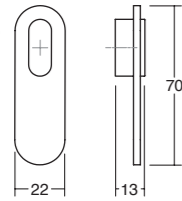

	26 Beige / Beige	36 Brown / Marrón	99 Black / Negro	↓	📦
01 Polished chrome/ Cromo brillo	0507070P2601	0507070P3601	0507070P9901	1	25
01 Polished chrome/ Cromo brillo	0507160P2601	0507160P3601	0507160P9901	2	25
28 Brushed gold / Oro cepillado	0507070P2628	0507070P3628	0507070P9928	1	25
28 Brushed gold / Oro cepillado	0507160P2628	0507160P3628	0507160P9928	2	25
31 Brushed grey / Gris cepillado	0507070P2631	0507070P3631	0507070P9931	1	25
31 Brushed grey / Gris cepillado	0507160P2631	0507160P3631	0507160P9931	2	25
M1 Matt white / Blanco mate	0507070P26M1	-	-	1	25
M1 Matt white / Blanco mate	0507160P26M1	-	-	2	25
M2 Matt black / Negro mate	0507070P26M2	0507070P36M2	0507070P99M2	1	25
M2 Matt black / Negro mate	0507160P26M2	0507160P36M2	0507160P99M2	2	25



0494 **LAND** ZAMAK Design: Héctor Diego **NEW!**

0494 - 040

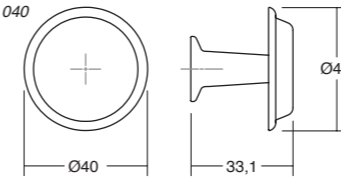

0494 - 064

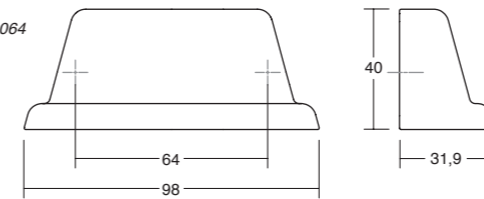

28 Brushed gold Oro cepillado	610 Pewter Peltre	614 Antique brass Latón antiguo	M2 Matt black Negro mate	↓	📦
0494040Z28	0494040Z2610	0494040Z614	0494040ZM2	1	25
0494064Z28	0494064Z2610	0494064Z614	0494064ZM2	2	25

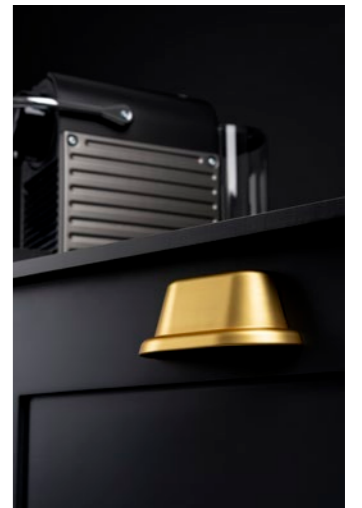
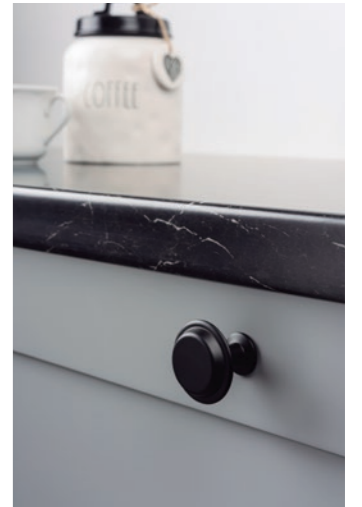

0459 **LINES** ZAMAK Design: Teruel - Paré

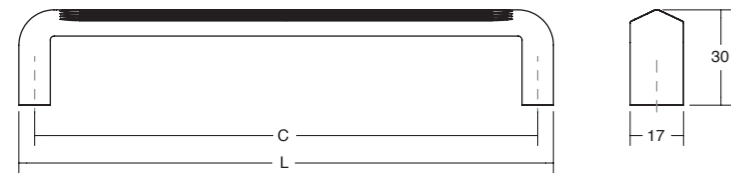

23 Brushed Níquel Níquel cepillado	28 Brushed gold Oro cepillado	32 Brushed mole grey Gris topo cepillado	M2 Matt black Negro mate	C	L	↓	📦
0459160Z23	0459160Z28	0459160Z32	0459160ZM2	160	170	2	25
0459320Z23	0459320Z28	0459320Z32	0459320ZM2	320	330	2	25



0467 **SKALA** ALUMINIUM Design: Alexis Vivet

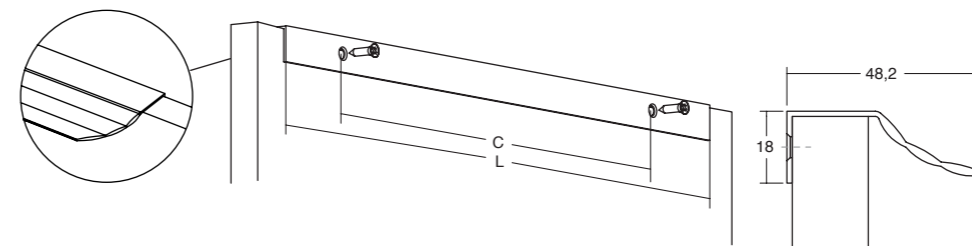

30 Brushed black Negro cepillado	31 Brushed grey Gris cepillado	613 Antique bronze Bronce antiguo	618 Brushed brass cava Latón cava cepillado	C	L	↓	📦
0467128L30	0467128L31	0467128L613	0467128L618	128	200	2	25
0467256L30	0467256L31	0467256L613	0467256L618	256	350	2	25

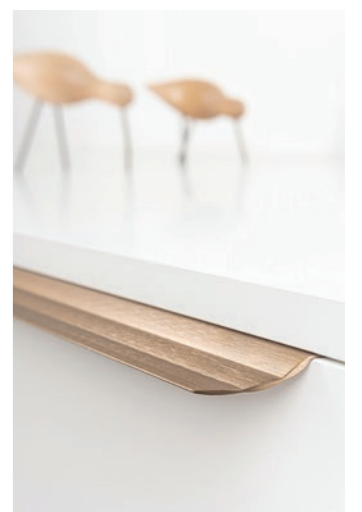

0506

**FIRM**

ZAMAK

Design: Frank Person

**NEW!**

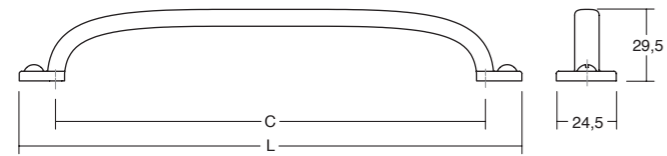

M22	C	L	↓	☐
Textured black <i>Negro texturizado</i>				
0506064ZM22	64	93,8	2	25
0506096ZM22	96	125,8	2	25
0506160ZM22	160	189,8	2	25
0506320ZM22	320	349,8	2	25

0516

**PENDANT**

ZAMAK

Design: Frank Person

**NEW!**

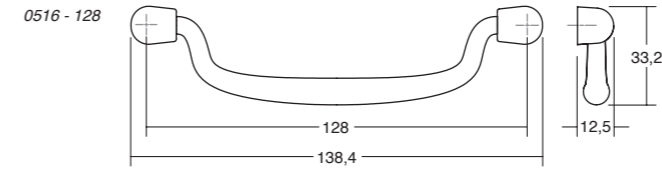
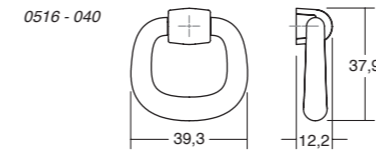
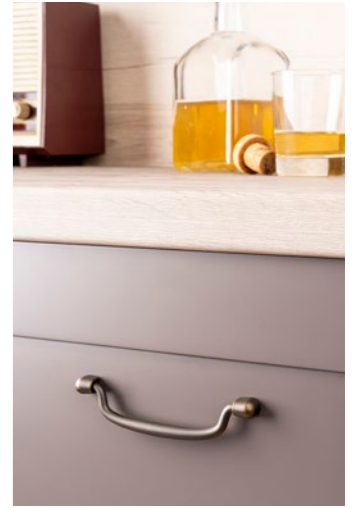
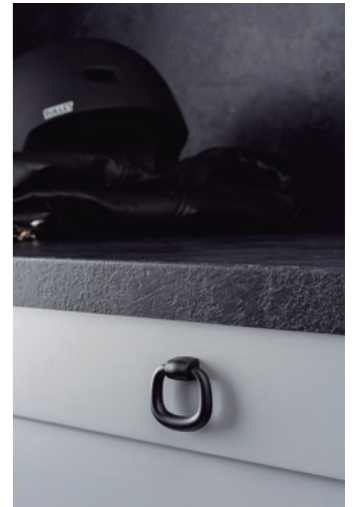

610	614	M2	↓	☐
Pewter <i>Peltre</i>	Antique brass <i>Latón antiguo</i>	Matt black <i>Negro mate</i>		
0516040Z610	0516040Z614	0516040ZM2	1	25
0516128Z610	0516128Z614	0516128ZM2	2	25

0480

**NICE**

ZAMAK

Design: Héctor Diego

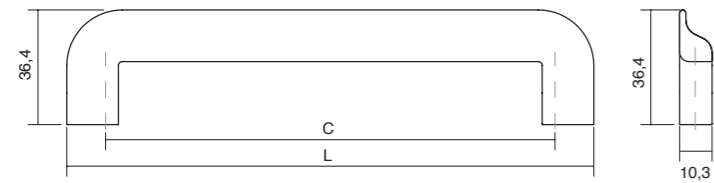

23	28	32	M2	C	L	↓	☐
Brushed Nickel <i>Níquel cepillado</i>	Brushed gold <i>Oro cepillado</i>	Brushed mole grey <i>Gris topo cepillado</i>	Matt black <i>Negro mate</i>				
0480160Z23	0480160Z28	0480160Z32	0480160ZM2	160	184.6	2	25
0480320Z23	0480320Z28	0480320Z32	0480320ZM2	320	344.6	2	25

0446

**ESTE**

ZAMAK

Design: Balutto Associati

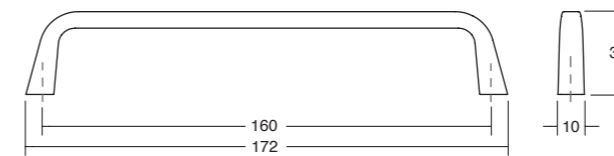
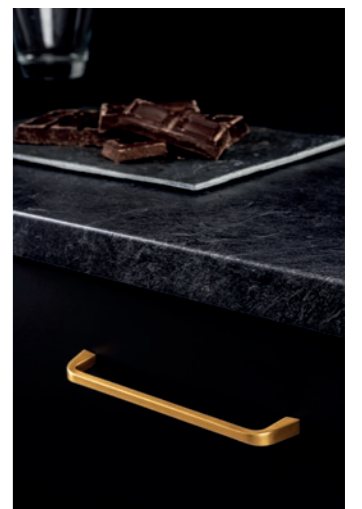

01	11	23	26	28	617	M2	↓	☐
Polished chrome <i>Cromo brillo</i>	Matt chrome <i>Cromo mate</i>	Brushed nickel <i>Níquel cepillado</i>	Brushed copper <i>Cobre cepillado</i>	Brushed gold <i>Oro cepillado</i>	Graphite grey <i>Gris grafito</i>	Matt black <i>Negro mate</i>		
0446160Z01	0446160Z11	0446160Z23	0446160Z26	0446160Z28	0446160Z617	0446160ZM2	2	25

0486 **GRAF BIG** ALUMINIUM Design: Viefte®

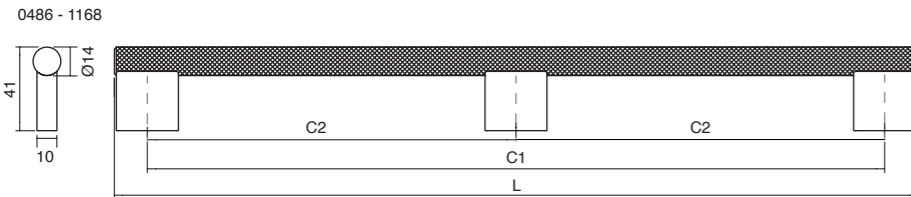
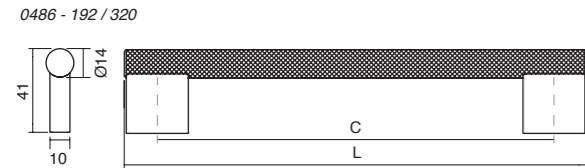
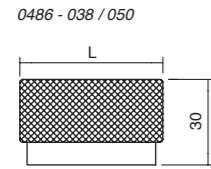

24 Stainless steel look Inox look	291 Brush dark brass Latón oscuro cepillado	30 Brushed black Negro cepillado	C1	C2	L	↓	☐
0486038L24	0486038L291	0486038L30	-	-	Ø38	1	25
0486050L24	0486050L291	0486050L30	-	-	Ø50	1	25
0486192L24	0486192L291	0486192L30	192	-	224	2	25
0486320L24	0486320L291	0486320L30	320	-	352	2	25
04861168L24	04861168L291	04861168L30	1168	584	1200	3	10

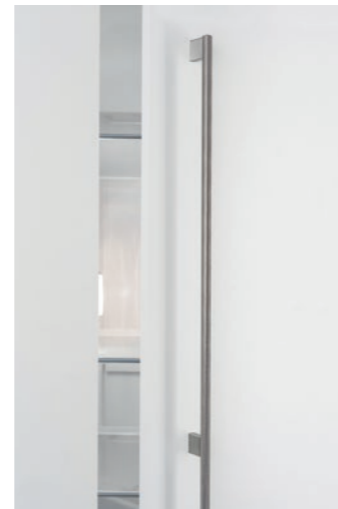

0430 **GRAF MINI** ALUMINIUM Design: Viefte®

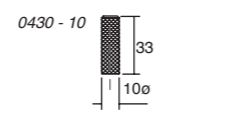
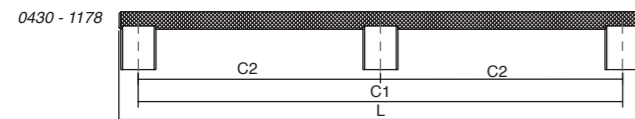
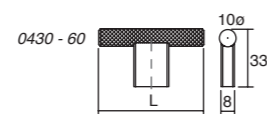
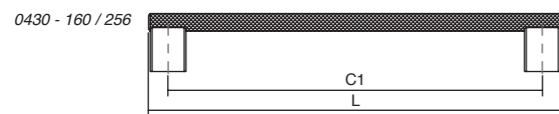

24 Stainless steel look Inox look	291 Brushed dark brass Latón oscuro cepillado	30 Brushed black Negro cepillado	C1	C2	L	↓	☐
0430010L24	0430010L291	0430010L30	-	-	10	1	25
0430060L24	0430060L291	0430060L30	-	-	60	1	25
0430160L24	0430160L291	0430160L30	160	-	182	2	25
0430256L24	0430256L291	0430256L30	256	-	278	2	25
04301178L24	04301178L291	04301178L30	1178	589	1200	3	10

0109 **GRAF** ALUMINIUM Design: Viefte®

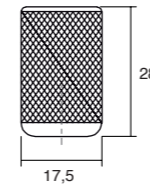

01 Polished chrome Cromo brillo	04 Anodized matt Anodizado mate	24 Stain. steel look Inox look	27 Brushed brass Latón cepillado	291 Brushed dark brass Latón oscuro cepillado	M2 Matt black Negro mate	↓	☐
0109017L01	0109017L04	0109017L24	0109017L27	0109017L291	0109017LM2	1	25



0447 **BELLA** ZAMAK Design: Balutto Associati

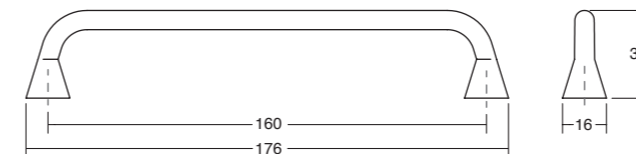

26 Brushed copper Cobre cepillado	28 Brushed gold Oro cepillado	617 Graphite grey Gris grafito	M2 Matt black Negro mate	↓	☐
0447160Z26	0447160Z28	0447160Z617	0447160ZM2	2	25

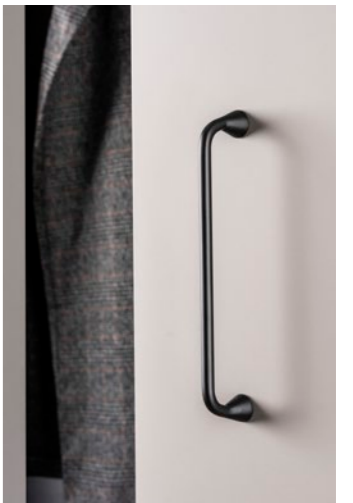

0451 **FELTRE** ZAMAK Design: Balutto Associati

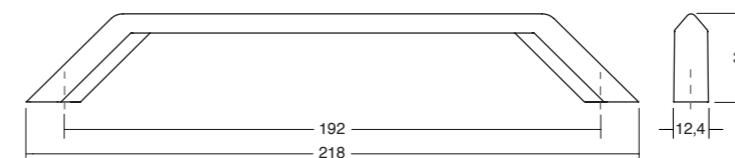

23 Brushed nickel Níquel cepillado	617 Graphite grey Gris grafito	M2 Matt black Negro mate	↓	☐
0451192Z23	0451192Z617	0451192ZM2	2	25



0449 **HEXXA** ALUMINIUM/ZAMAK Design: Alexis Vivet

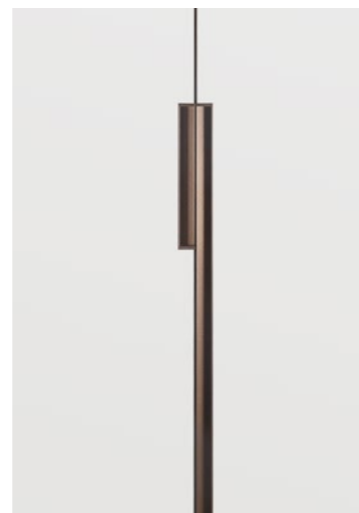
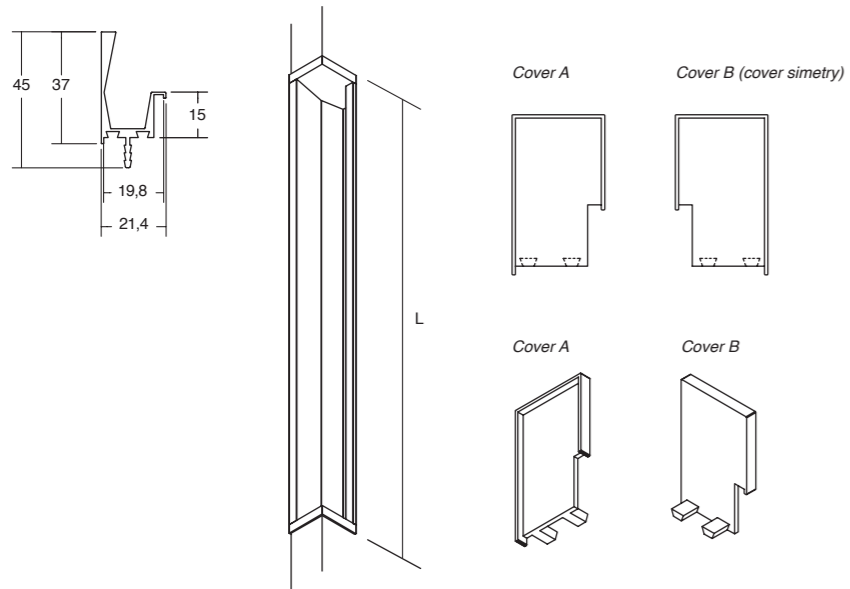

M1	M2	M23	M41	L	⬇	📦
Matt white Blanco mate	Matt black Negro mate	Metallic grey Gris metal	Metallic brown Marrón metal			
0449200LM1	0449200LM2	0449200LM23	0449200LM41	200	25	ALUMINIUM
0449350LM1	0449350LM2	0449350LM23	0449350LM41	350	25	ALUMINIUM
04491100LM1	04491100LM2	04491100LM23	04491100LM41	1100	15	ALUMINIUM
04493000LM1	04493000LM2	04493000LM23	04493000LM41	3000	10	ALUMINIUM
0449035ZM1A	0449035ZM2A	0449035ZM23A	0449035ZM41A	-	25	ZAMAK
0449035ZM1B	0449035ZM2B	0449035ZM23B	0449035ZM41B	-	25	ZAMAK

0119 **WAVE** ZAMAK Design: Viefe®

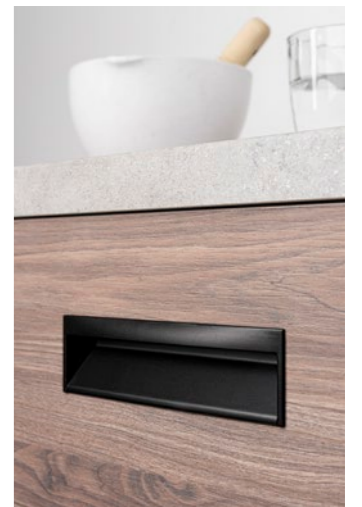
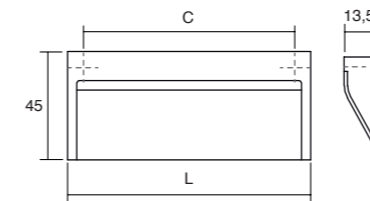

01	23	M2	C	L	⬇	📦
Polished chrome Cromo brillo	Brushed nickel Níquel cepillado	Matt black Negro mate				
0119032Z01	0119032Z23	0119032ZM2	32	45	2	25
0119160Z01	0119160Z23	0119160ZM2	160	173	2	25

0105 **NEST** ZAMAK Design: Viefe®

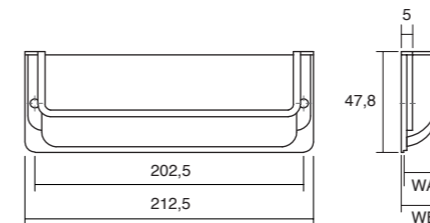

01	01 + M1	23	23 + M1	M2	WA	WB	⬇	📦	Door
Polished chrome Cromo brillo	Polished chrome+White Cromo brillo+ Blanco	Brushed nickel Níquel cepillado	Brushed nickel+White Níquel cepillado+Blanco	Matt black Negro mate					Puerta
0105186Z01ST	0105186Z01M1	0105186Z23ST	0105186Z23M1	0105186ZM2ST	18,6	21,3	2	25	19
-	-	0105206Z23ST	-	-	20,6	23,3	2	25	20,5

0094 **HIDE** ZAMAK Design: Viefe®

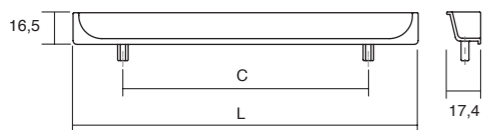

01	23	28 NEW!	P1	M1	M2	C	L	⬇	📦
Polished chrome Cromo brillo	Brushed nickel Níquel cepillado	Brushed gold Oro cepillado	Chrome look Cromo look	Matt white Blanco mate	Matt black Negro mate				
0094090Z01	0094090Z23	0094090Z28	-	0094090ZM1	0094090ZM2	64	90	2	25
0094180Z01	0094180Z23	0094180Z28	-	0094180ZM1	0094180ZM2	128	180	2	25
-	-	-	0094200ZP1	-	-	128	200	2	25

0235 **CLOS** ZAMAK Design: Viefe®

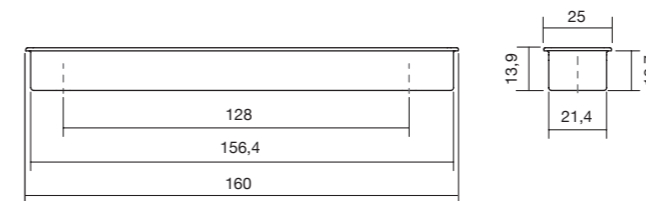

M1	M2	Z01	Z23	⬇	📦
Matt white Blanco mate	Matt black Negro mate	Polished chrome Cromo brillo	Brushed nickel Níquel cepillado		
0235128ZM1	0235128ZM2	0235128Z01	0235128Z23	2	25

0366 **CUBIC** ZAMAK Design: Viefe®

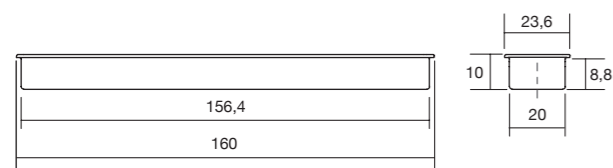

M1	M2	
Matt white <i>Blanco mate</i>	Matt black <i>Negro mate</i>	
0366160ZM1	0366160ZM2	25



0195 **SENSE** ALUMINIUM Design: Viefe®

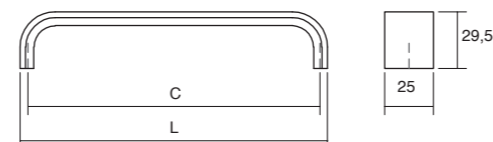

01	24	30	C	L	↓	
Polished chrome <i>Cromo brillo</i>	Stainless steel look <i>Inox look</i>	Brushed black <i>Negro cepillado</i>				
0195128L01	0195128L24	0195128L30	128	135	2	25
0195192L01	0195192L24	0195192L30	192	199	2	25
0195320L01	0195320L24	0195320L30	320	327	2	25
0195480L01	0195480L24	0195480L30	480	487	2	25



0073 **TAP** ZAMAK Design: Viefe®

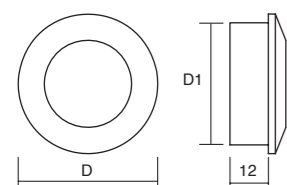

P1	M2	D	D1	
Chrome look <i>Cromo look</i>	Matt black <i>Negro mate</i>			
0073040ZP1	0073040ZM2	40	35,5	25
0073060ZP1	0073060ZM2	60	55,3	25



0162 **KADO** ZAMAK Design: Viefe®

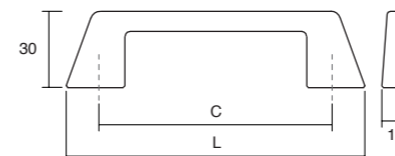

01	23	C	L	↓	
Polished chrome <i>Cromo brillo</i>	Brushed nickel <i>Níquel cepillado</i>				
0162160Z01	0162160Z23	160	186	2	25
0162320Z01	0162320Z23	320	346	2	25



0301 **SENSE MINI** ALUMINIUM Design: Viefe®

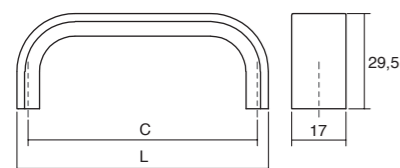

01	09	24	29	C	L	↓	
Polished chrome <i>Cobre brillo</i>	Matt black <i>Negro mate</i>	Stainless steel look <i>inox look</i>	Brushed dark brass <i>Latón oscuro cepillado</i>				
0301096L01	0301096L09	0301096L24	0301096L29	96	103	2	25
0301160L01	0301160L09	0301160L24	0301160L29	160	167	2	25
0301256L01	0301256L09	0301256L24	0301256L29	256	263	2	25



0457 **BACKK** ZAMAK Design: Alexis Vivet

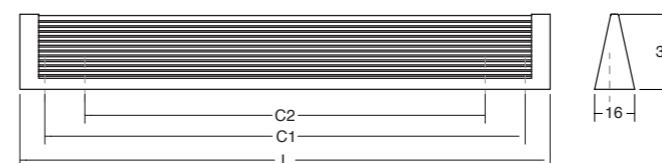

M22	C1	C2	L	↓	
Textured black <i>Negro texturizado</i>					
0457096ZM22	96	-	116	2	25
0457192ZM22	192	160	212	4	25



0077 **ANGLE** ALUMINIUM Design: Viefef®

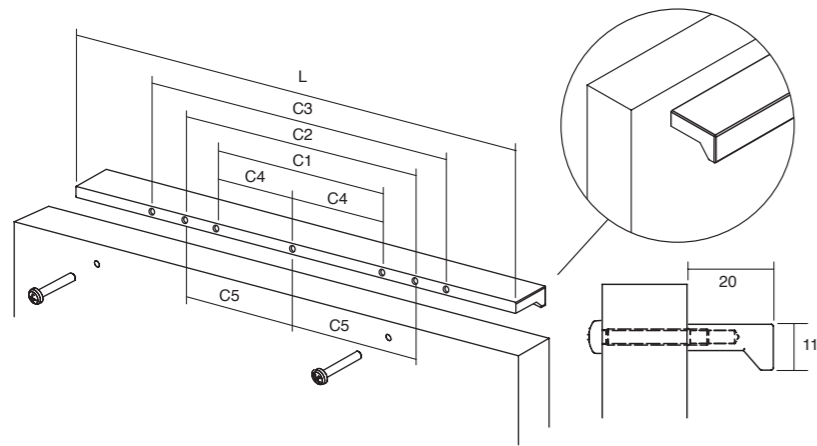

01	04	24	M1	M2	M23	M41	C1	C2	C3	C4	C5	L	↓	⊞
Polished chrome	Anodized matt	Stain. steel look	Matt White	Matt black	Metallic grey	Metallic brown								
Cromo brillo	Anodizado mate	Inox look	Blanco mate	Negro mate	Gris metal	Marrón metal								
-	0077032L04	-	-	-	-	-	32	-	-	-	-	45	2	25
-	0077064L04	-	-	-	-	-	64	-	-	-	-	90	2	25
0077064L01	-	0077064L24	0077064LM1	0077064LM2	0077064LM23	0077064LM41	64	-	-	-	-	100	2	25
-	-	-	0077128LM1	0077128LM2	0077128LM23	0077128LM41	128	160	-	-	-	200	4	25
-	0077096L04	-	-	-	-	-	96	-	-	-	-	120	2	25
-	0077128L04	-	-	-	-	-	128	-	-	-	-	150	2	25
0077128L01	-	0077128L24	-	-	-	-	96	128	160	-	-	200	6	25
-	0077160L04	-	-	-	-	-	160	-	-	-	-	190	2	25
-	0077192L04	-	-	-	-	-	192	-	-	-	-	250	2	25
0077192L01	-	0077192L24	0077192LM1	0077192LM2	0077192LM23	0077192LM41	192	-	-	-	-	300	2	25
-	-	-	0077256LM1	0077256LM2	0077256LM23	0077256LM41	256	-	-	-	-	400	2	25
-	0077256L04	-	-	-	-	-	256	-	-	-	-	300	2	25
0077256L01	-	0077256L24	-	-	-	-	256	320	-	-	-	400	4	25
-	-	-	0077416LM1	0077416LM2	0077416LM23	0077416LM41	416	-	-	-	-	500	2	25
0077416L01	-	0077416L24	-	-	-	-	320	416	-	-	-	500	4	25
-	-	-	0077480LM1	0077480LM2	0077480LM23	0077480LM41	480	-	-	-	-	600	2	25
0077512L01	-	0077512L24	-	-	-	-	480	512	-	-	256	600	5	25
0077640L01	-	0077640L24	0077640LM1	0077640LM2	0077640LM23	0077640LM41	640	-	-	320	-	900	3	25
-	-	-	00771440LM1	00771440LM2	00771440LM23	00771440LM41	480	1440	-	-	-	1480	4	10

0452 **BRAVE** ALUMINIUM Design: Viefef®

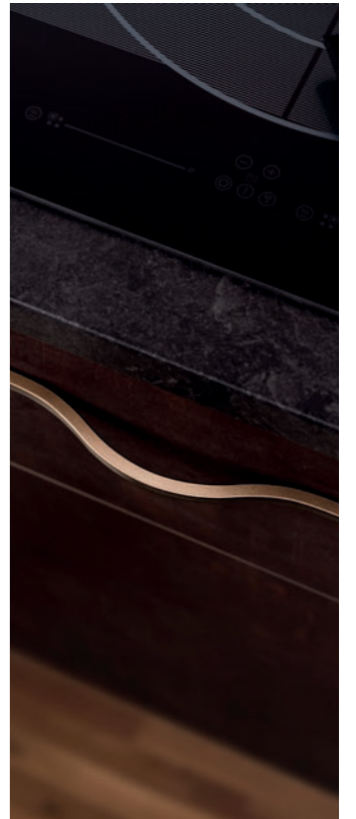
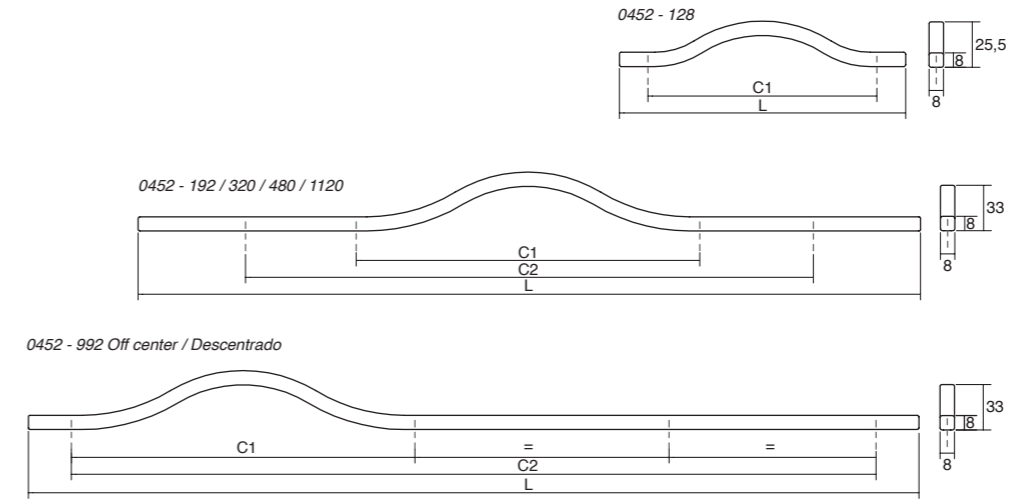

M1	M2	M23	M41	C1	C2	L	↓	⊞
Matt white	Matt black	Metallic grey	Metallic brown					
Blanco mate	Negro mate	Gris metal	Marrón metal					
0452128FM1	0452128FM2	0452128FM23	0452128FM41	128	-	160	2	25
0452192FM1	0452192FM2	0452192FM23	0452192FM41	192	-	240	2	25
0452320FM1	0452320FM2	0452320FM23	0452320FM41	320	-	400	2	25
0452480FM1	0452480FM2	0452480FM23	0452480FM41	192	480	600	4	25
0452992FM1	0452992FM2	0452992FM23	0452992FM41	192	992	1040	4	15
04521120FM1	04521120FM2	04521120FM23	04521120FM41	192	1120	1150	4	15

0341 **ASI** ALUMINIUM Design: Oriol Barri

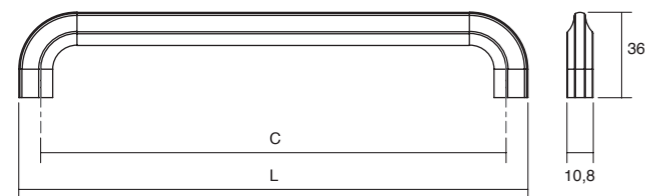

M2	C	L	↓	⊞
Matt black				
Negro mate				
0341128LM2	128	146	2	25
0341192LM2	192	210	2	25
0341320LM2	320	338	2	25

0465 **STRATT** ALUMINIUM Design: Alexis Vivet

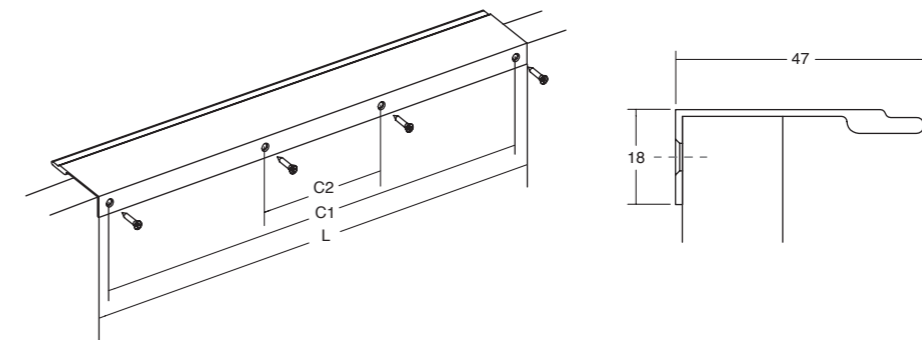

04	09	24	C1	C2	L	↓	⊞
Anodized matt	Matt black	Stainless steel look					
Anodizado mate	Negro mate	Inox look					
0465032L04	0465032L09	0465032L24	32	-	50	2	25
0465128L04	0465128L09	0465128L24	128	-	150	2	25
0465192L04	0465192L09	0465192L24	192	-	250	2	25
04651056L04	04651056L09	04651056L24	1056	416	1100	4	15

0444 **PEAK** ALUMINIUM Design: Viefé®

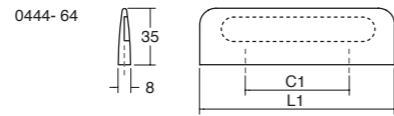

0444 - 1760 / 768 / 448 / 192

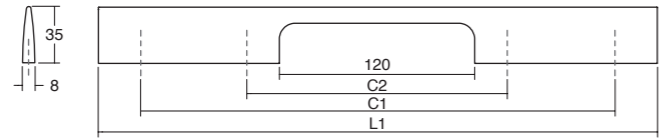

0444- 1120 Off center / Descentrado

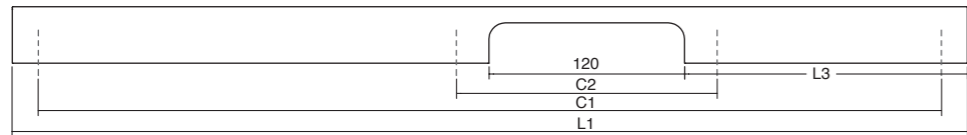

24	30	M1	M23	M41	C1	C2	L1	L3	↓	☐
Stain. steel look Inox look	Brushed black Negro cepillado	Matt white Blanco mate	Metallic grey Gris metal	Metallic brown Marrón metal						
0444064L24	0444064L30	0444064LM1	0444064LM23	0444064LM41	64	-	120	-	2	25
0444192L24	0444192L30	0444192LM1	0444192LM23	0444192LM41	192	160	250	-	4	25
0444448L24	0444448L30	0444448LM1	0444448LM23	0444448LM41	448	160	500	-	4	25
0444768L24	0444768L30	0444768LM1	0444768LM23	0444768LM41	768	160	800	-	4	15
04441120L24	04441120L30	04441120LM1	04441120LM23	04441120LM41	1120	160	1150	190	4	15
04441760L24	04441760L30	04441760LM1	04441760LM23	04441760LM41	1760	160	1800	-	4	10

0373 **NICK** ZAMAK Design: Alexis Vivet

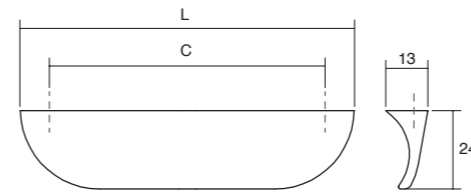

01	23	26	27	C	L	↓	☐
Polished chrome Cromo brillo	Brushed nickel Níquel cepillado	Brushed copper Cobre cepillado	Brushed brass Latón cepillado				
0373032Z01	0373032Z23	0373032Z26	0373032Z27	32	50	2	25
0373160Z01	0373160Z23	0373160Z26	0373160Z27	160	178	2	25



0370 **SREE** ZAMAK Design: Alexis Vivet

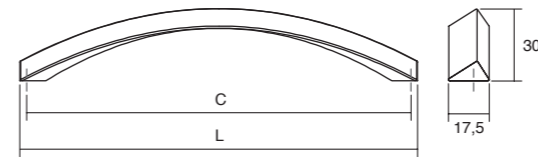

01	23	27	C	L	↓	☐
Polished chrome Cromo brillo	Brushed nickel Níquel cepillado	Brushed brass Latón cepillado				
0370160Z01	0370160Z23	0370160Z27	160	166	2	25
0370224Z01	0370224Z23	0370224Z27	224	231	2	25

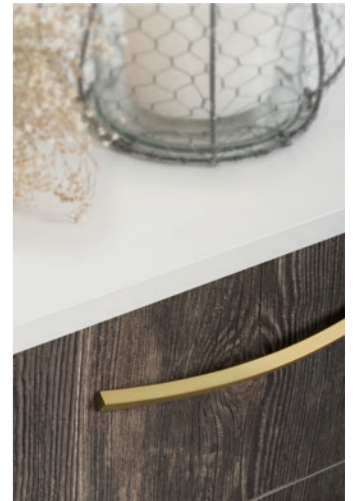

0053 **DINO** ZAMAK Design: Viefé®

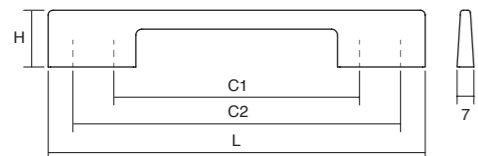

01	23	M1	M2	P4	C1	C2	L	H	↓	☐
Polished chrome Cromo brillo	Brushed nickel Níquel cepillado	Matt white Blanco mate	Matt black Negro mate	Aluminium look Aluminio look						
0053096Z01	0053096Z23	0053096ZM1	0053096ZM2	0053096ZP4	96	128	156	24	4	25
0053192Z01	0053192Z23	0053192ZM1	0053192ZM2	0053192ZP4	160	192	221	28	4	25
0053320Z01	0053320Z23	0053320ZM1	0053320ZM2	0053320ZP4	288	320	349	28	4	25



0306 **KARES** ZAMAK Design: Alexis Vivet

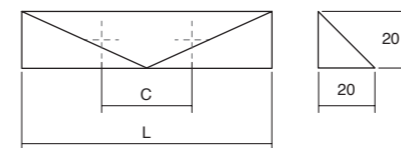

01	23	M1	C	L	↓	☐
Polished chrome Cromo brillo	Brushed nickel Níquel cepillado	Matt white Blanco mate				
0306032Z01	0306032Z23	0306032ZM1	32	88	2	25
0306096Z01	0306096Z23	0306096ZM1	96	152	2	25
0306192Z01	0306192Z23	0306192ZM1	192	312	2	25





0206 **ARCH** ZAMAK Design: 2J Design

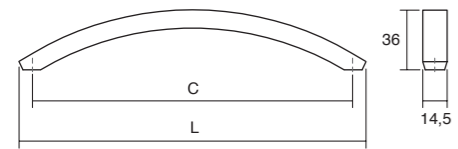

01	23	C	L	↓	☐
Polished chrome	Brushed nickel				
Cromo brillo	Níquel cepillado				
0206192Z01	0206192Z23	192	208,5	2	25
0206320Z01	0206320Z23	320	338,5	2	25



0372 **ONA** ALUMINIUM Design: Teruel Paré

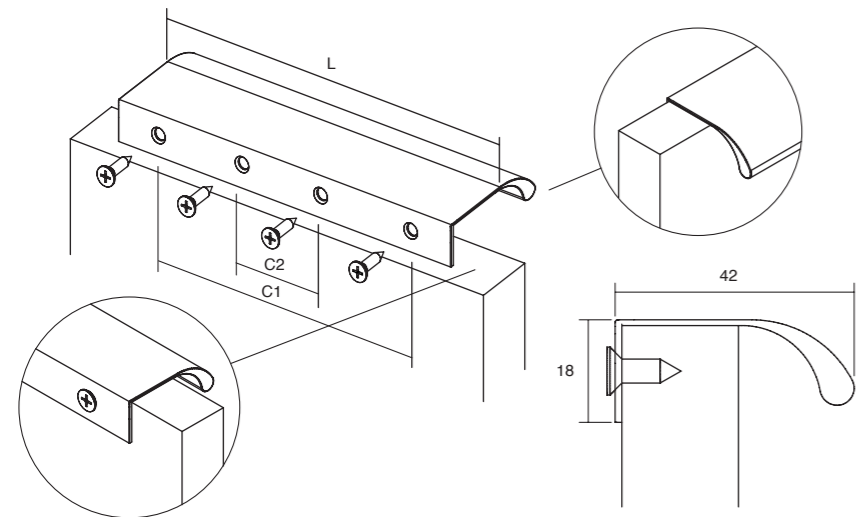

24	30	31	M1	M23	M41	C1	C2	L	↓	☐
Stainless steel look	Brushed black	Brushed grey	Matt white	Metallic grey	Metallic brown					
Inox look	Negro cepillado	Gris cepillado	Blanco mate	Gris metal	Marrón metal					
0372032L24	0372032L30	0372032L31	0372032LM1	0372032LM23	0372032LM41	32	-	50	2	25
0372128L24	0372128L30	0372128L31	0372128LM1	0372128LM23	0372128LM41	128	-	200	2	25
0372256L24	0372256L30	0372256L31	0372256LM1	0372256LM23	0372256LM41	256	-	350	2	25
0372544L24	0372544L30	0372544L31	0372544LM1	0372544LM23	0372544LM41	544	-	600	3	25
03721056L24	03721056L30	03721056L31	03721056LM1	03721056LM23	03721056LM41	1056	416	1100	4	15
03721440L24	03721440L30	03721440L31	03721440LM1	03721440LM23	03721440LM41	1440	480	1500	4	10

0375 **VANN** ALUMINIUM Design: Alexis Vivet

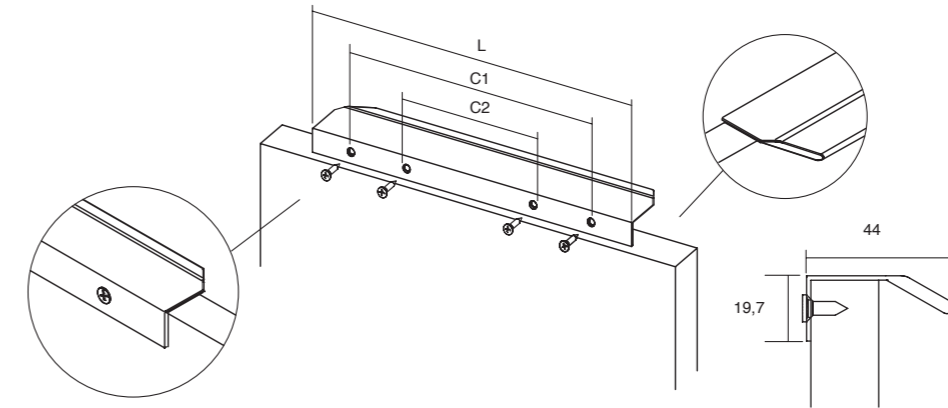

02	04	09	24	29	C1	C2	L	↓	☐
Anodized bright	Anodized matt	Matt black	Stain steel look	Brushed dark brass					
Anodizado brillo	Anodizado mate	Negro mate	Inox look	Latón oscuro cepill.					
0375064L02	0375032L04	0375032L09	0375032L24	0375032L29	64	-	100	2	25
0375128L02	0375128L04	0375128L09	0375128L24	0375128L29	128	-	200	2	25
0375256L02	0375256L04	0375256L09	0375256L24	0375256L29	256	-	350	2	25
-	03751120L04	03751120L09	03751120L24	03751120L29	1120	384	1200	4	15

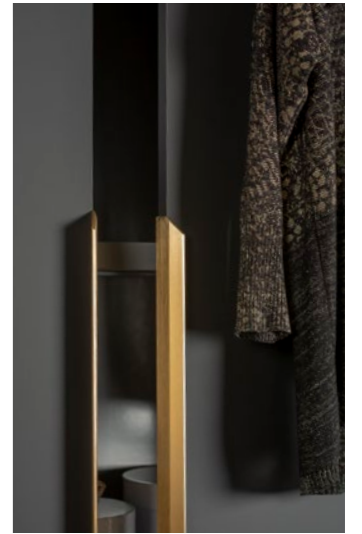

0322 **CUTT** ALUMINIUM Design: Alexis Vivet

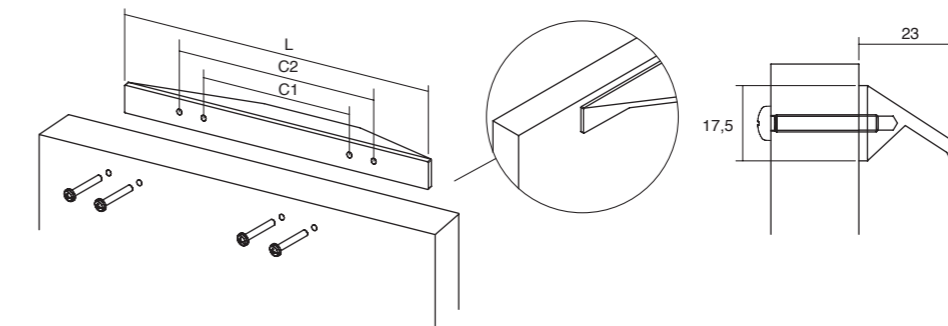

01	09	24	C1	C2	L	↓	☐
Polished chrome	Matt black	Stainless steel look					
Cromo brillo	Negro mate	Inox look					
0322200L01	0322200L09	0322200L24	96	128	200	4	25
0322400L01	0322400L09	0322400L24	192	320	400	4	25
0322600L01	0322600L09	0322600L24	320	480	600	4	25
-	03221000L09	03221000L24	320	896	1000	4	15
-	03221500L09	03221500L24	480	1376	1500	4	10



0117 **CURVE** ALUMINIUM Design: Viefie®

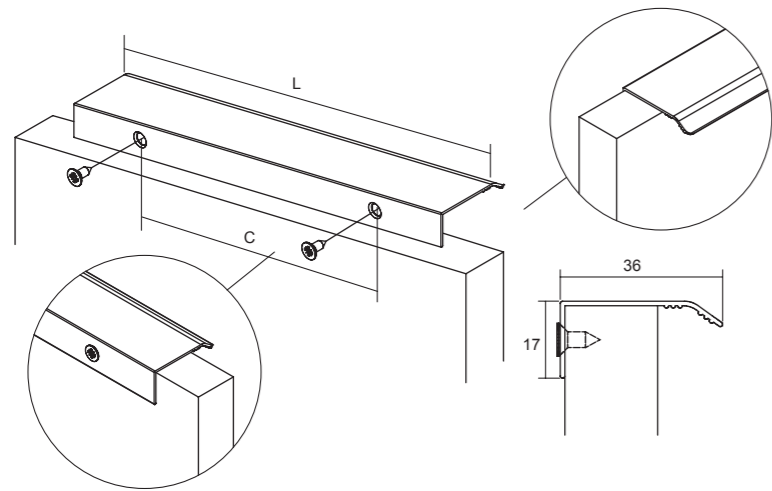

04	24	31	M1	M2	C	L	↓	☐
Anodized matt	Stainless steel look	Brushed grey	Matt white	Matt black				
Anodizado mate	Inox look	Gris cepillado	Blanco mate	Negro mate				
0117032L04	0117032L24	0117032L31	0117032LM1	0117032LM2	32	45	2	25
-	0117064L24	-	-	-	64	100	2	25
0117128L04	0117128L24	0117128L31	0117128LM1	0117128LM2	128	200	2	25
-	0117192L24	-	-	-	192	300	2	25
-	0117320L24	-	-	-	320	400	3	25
-	0117416L24	-	-	-	416	500	3	25

0434 / 0435 / 0436 **VECTOR** ALUMINIUM Design: Viefie®



24	30	31	L	W1	W2	☐	Door
S. steel look	Brushed black	Brushed grey					
Inox look	Negro cepillado	Gris cepillado					Puerta
0434147L24	0434147L30	0434147L31	147	41	19,8	15	19
0434197L24	0434197L30	0434197L31	197	41	19,8	15	19
0434247L24	0434247L30	0434247L31	247	41	19,8	15	19
0434297L24	0434297L30	0434297L31	297	41	19,8	15	19
0434347L24	0434347L30	0434347L31	347	41	19,8	15	19
0434397L24	0434397L30	0434397L31	397	41	19,8	15	19
0434447L24	0434447L30	0434447L31	447	41	19,8	10	19
0434497L24	0434497L30	0434497L31	497	41	19,8	10	19
0434597L24	0434597L30	0434597L31	597	41	19,8	10	19
0434697L24	0434697L30	0434697L31	697	41	19,8	10	19
0434797L24	0434797L30	0434797L31	797	41	19,8	10	19
0434897L24	0434897L30	0434897L31	897	41	19,8	5	19
0434997L24	0434997L30	0434997L31	997	41	19,8	5	19
04341197L24	04341197L30	04341197L31	1197	41	19,8	5	19

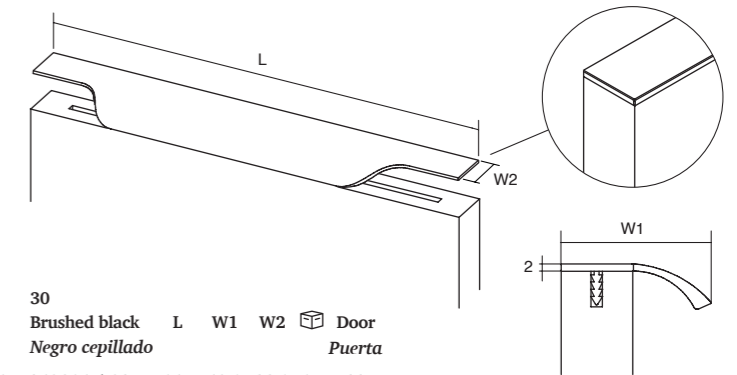

24	30	L	W1	W2	☐	Door	24	30	L	W1	W2	☐	Door
S. steel look	Brushed black						S. steel look	Brushed black					
Inox look	Negro cepillado						Inox look	Negro cepillado					Puerta
0435147L24	0435147L30	147	43,8	21	15	20,5	0436147L24	0436147L30	147	43,8	22,8	15	22
0435197L24	0435197L30	197	43,8	21	15	20,5	0436197L24	0436197L30	197	43,8	22,8	15	22
0435247L24	0435247L30	247	43,8	21	15	20,5	0436247L24	0436247L30	247	43,8	22,8	15	22
0435297L24	0435297L30	297	43,8	21	15	20,5	0436297L24	0436297L30	297	43,8	22,8	15	22
0435347L24	0435347L30	347	43,8	21	15	20,5	0436347L24	0436347L30	347	43,8	22,8	15	22
0435397L24	0435397L30	397	43,8	21	15	20,5	0436397L24	0436397L30	397	43,8	22,8	15	22
0435447L24	0435447L30	447	43,8	21	10	20,5	0436447L24	0436447L30	447	43,8	22,8	10	22
0435497L24	0435497L30	497	43,8	21	10	20,5	0436497L24	0436497L30	497	43,8	22,8	10	22
0435597L24	0435597L30	597	43,8	21	10	20,5	0436597L24	0436597L30	597	43,8	22,8	10	22
0435697L24	0435697L30	697	43,8	21	10	20,5	0436697L24	0436697L30	697	43,8	22,8	10	22
0435797L24	0435797L30	797	43,8	21	10	20,5	0436797L24	0436797L30	797	43,8	22,8	10	22
0435897L24	0435897L30	897	43,8	21	5	20,5	0436897L24	0436897L30	897	43,8	22,8	5	22
0435997L24	0435997L30	997	43,8	21	5	20,5	0436997L24	0436997L30	997	43,8	22,8	5	22
04351197L24	04351197L30	1197	43,8	21	5	20,5	04361197L24	04361197L30	1197	43,8	22,8	5	22

0139 / 0140 **LINEAR** ALUMINIUM Design: Viefie®

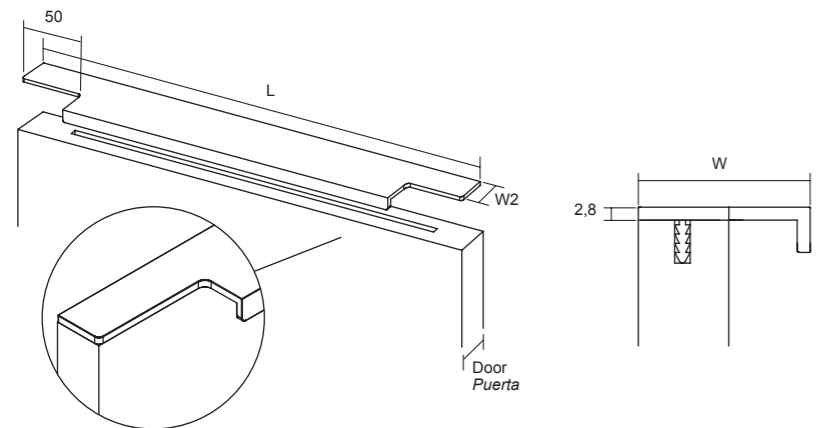

24	30	L	W (d19)	W2	☐	Door	24	30	L	W (d20,5)	W2	☐	Door
Stain. steel look	Brushed black						Stain. steel look	Brushed black					
Inox look	Negro cepillado						Inox look	Negro cepillado					Puerta
0139147L24	0139147L30	147	37	19,8	15	19mm	0140147L24	0140147L30	147	38,5	21	15	20,5mm
0139197L24	0139197L30	197	37	19,8	15	19mm	0140197L24	0140197L30	197	38,5	21	15	20,5mm
0139247L24	0139247L30	247	37	19,8	15	19mm	0140247L24	0140247L30	247	38,5	21	15	20,5mm
0139297L24	0139297L30	297	37	19,8	15	19mm	0140297L24	0140297L30	297	38,5	21	15	20,5mm
0139347L24	0139347L30	347	37	19,8	15	19mm	0140347L24	0140347L30	347	38,5	21	15	20,5mm
0139397L24	0139397L30	397	37	19,8	15	19mm	0140397L24	0140397L30	397	38,5	21	15	20,5mm
0139447L24	0139447L30	447	37	19,8	10	19mm	0140447L24	0140447L30	447	38,5	21	10	20,5mm
0139497L24	0139497L30	497	37	19,8	10	19mm	0140497L24	0140497L30	497	38,5	21	10	20,5mm
0139597L24	0139597L30	597	37	19,8	10	19mm	0140597L24	0140597L30	597	38,5	21	10	20,5mm
0139697L24	0139697L30	697	37	19,8	10	19mm	0140697L24	0140697L30	697	38,5	21	10	20,5mm
0139797L24	0139797L30	797	37	19,8	10	19mm	0140797L24	0140797L30	797	38,5	21	10	20,5mm
0139897L24	0139897L30	897	37	19,8	5	19mm	0140897L24	0140897L30	897	38,5	21	5	20,5mm
0139997L24	0139997L30	997	37	19,8	5	19mm	0140997L24	0140997L30	997	38,5	21	5	20,5mm
01391197L24	01391197L30	1197	37	19,8	5	19mm	01401197L24	01401197L30	1197	38,5	21	5	20,5mm

0254/0255 **NOMA** ALUMINIUM Design: 2J Design

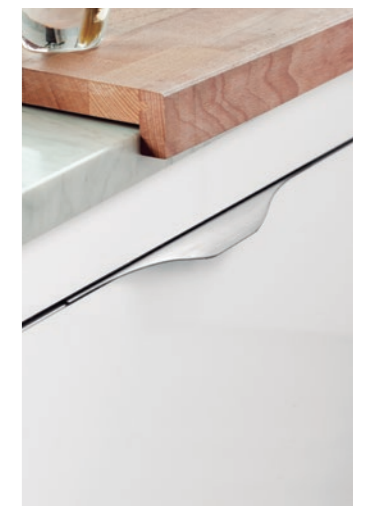
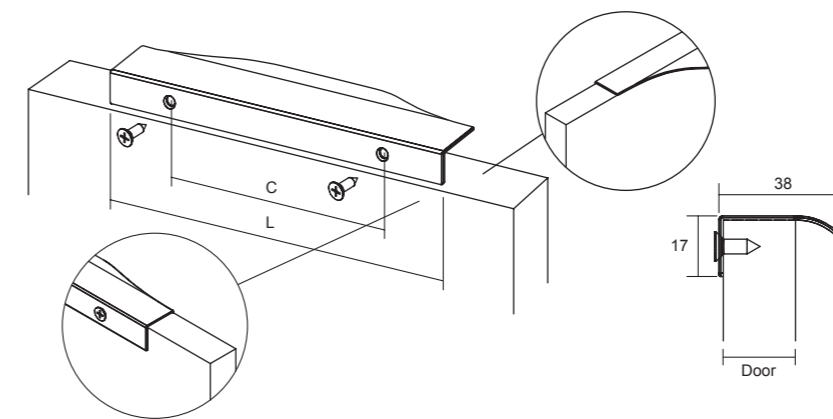

02	24	613	C	L	↓	☐	Door
Anodized bright	Stainless steel look	Antique bronze					
Anodizado brillo	Inox look	Bronze antiguo					Puerta
0254128L02	0254128L24	0254128L613	128	200	2	25	19
0254256L02	0254256L24	0254256L613	256	350	2	25	19
-	0255128L24	-	128	200	2	25	22
-	0255256L24	-	256	350	2	25	22

0250 / 0251 / 0253

**FORMA**

ALUMINIUM Design: 2J Design

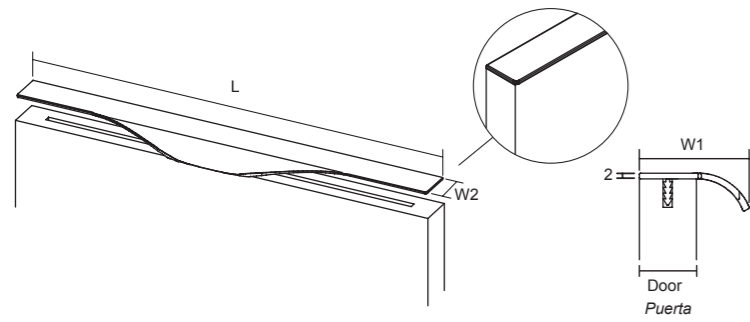

24	Stain. steel look	L	W1	W2	⊞	Door
Inox look						Puerta
0250147L24	147	38	19,8	15	19	
0250197L24	197	38	19,8	15	19	
0250247L24	247	38	19,8	15	19	
0250297L24	297	38	19,8	15	19	
0250347L24	347	38	19,8	15	19	
0250397L24	397	38	19,8	15	19	
0250447L24	447	38	19,8	10	19	
0250497L24	497	38	19,8	10	19	
0250597L24	597	38	19,8	10	19	
0250697L24	697	38	19,8	10	19	
0250797L24	797	38	19,8	10	19	
0250897L24	897	38	19,8	5	19	
0250997L24	997	38	19,8	5	19	
02501197L24	1197	38	19,8	5	19	

24	Stain. steel look	L	W1	W2	⊞	Door
Inox look						Puerta
0251147L24	147	40	21	15	20,5	
0251197L24	197	40	21	15	20,5	
0251247L24	247	40	21	15	20,5	
0251297L24	297	40	21	15	20,5	
0251347L24	347	40	21	15	20,5	
0251397L24	397	40	21	15	20,5	
0251447L24	447	40	21	10	20,5	
0251497L24	497	40	21	10	20,5	
0251597L24	597	40	21	10	20,5	
0251697L24	697	40	21	10	20,5	
0251797L24	797	40	21	10	20,5	
0251897L24	897	40	21	5	20,5	
0251997L24	997	40	21	5	20,5	
02511197L24	1197	40	21	5	20,5	

24	Stain. steel look	L	W1	W2	⊞	Door
Inox look						Puerta
0253147L24	147	40	22,8	15	22	
0253197L24	197	40	22,8	15	22	
0253247L24	247	40	22,8	15	22	
0253297L24	297	40	22,8	15	22	
0253347L24	347	40	22,8	15	22	
0253397L24	397	40	22,8	15	22	
0253447L24	447	40	22,8	10	22	
0253497L24	497	40	22,8	10	22	
0253597L24	597	40	22,8	10	22	
0253697L24	697	40	22,8	10	22	
0253797L24	797	40	22,8	10	22	
0253897L24	897	40	22,8	5	22	
0253997L24	997	40	22,8	5	22	
02531197L24	1197	40	22,8	5	22	

0311

**TAMM**

ALUMINIUM Design: Alexis Vivet

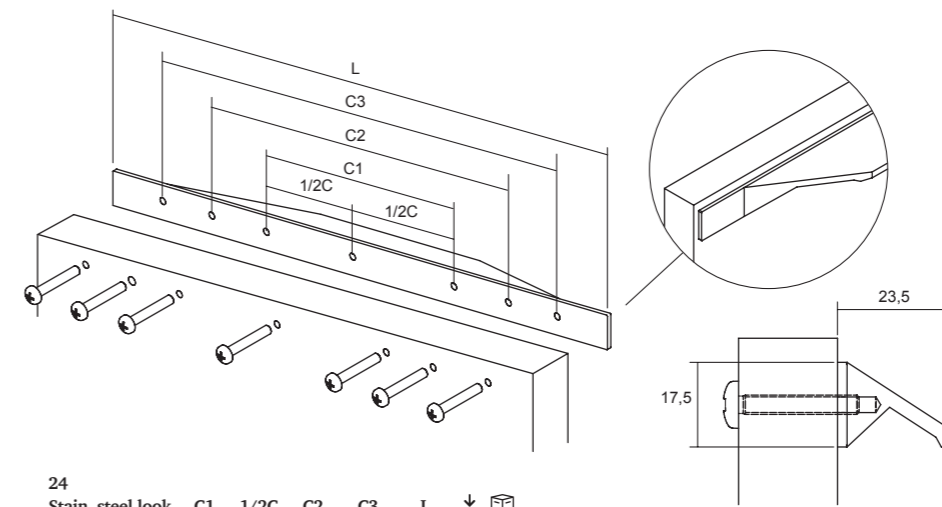

24	Stain. steel look	C1	1/2C	C2	C3	L	⬇	⊞
Inox look								
0311140L24	32	-	-	-	-	140	2	15
0311190L24	64	-	-	-	-	190	2	15
0311240L24	128	-	-	-	-	240	2	15
0311290L24	160	-	174	-	-	290	4	15
0311340L24	192	-	224	-	-	340	4	15
0311390L24	256	128	274	-	-	390	5	15
0311440L24	256	128	324	-	-	440	5	10
0311490L24	320	160	374	-	-	490	5	10
0311590L24	448	224	474	-	-	590	5	10
0311690L24	512	256	574	-	-	690	5	10
0311790L24	224	-	608	674	-	790	6	10
0311890L24	320	-	704	774	-	890	6	5
0311990L24	320	-	832	874	-	990	6	5
03111190L24	384	-	1024	1074	-	1190	6	5

0334

**BRIKK**

ALUMINIUM Design: Alexis Vivet

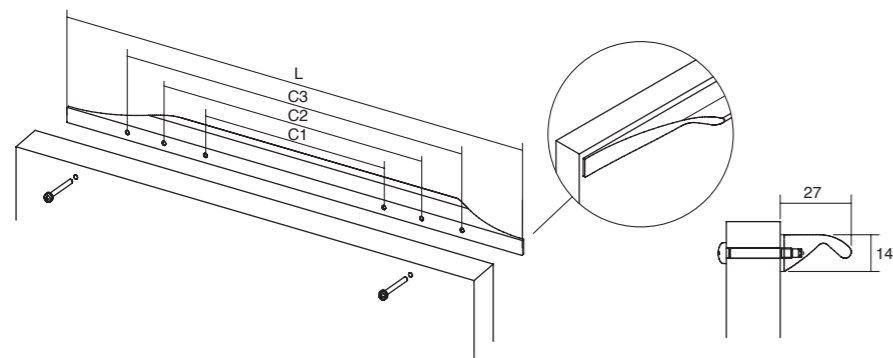

01	24	613	C1	C2	C3	L	⬇	⊞
Polished chrome	Stainless steel look	Antique bronze						
Cromo brillo	Inox look	bronce antiguo						
0334140L01	0334140L24	0334140L613	32	-	-	140	2	15
0334190L01	0334190L24	-	64	-	-	190	2	15
0334240L01	0334240L24	-	96	-	-	240	2	15
0334290L01	0334290L24	0334290L613	160	-	-	290	2	15
0334340L01	0334340L24	-	192	-	-	340	2	15
0334390L01	0334390L24	-	128	260	-	390	4	15
0334440L01	0334440L24	-	160	310	-	440	4	10
0334490L01	0334490L24	0334490L613	192	360	-	490	4	10
0334590L01	0334590L24	-	224	460	-	590	4	10
0334690L01	0334690L24	-	256	560	-	690	4	10
0334790L01	0334790L24	-	320	660	-	790	4	10
0334890L01	0334890L24	-	384	760	-	890	4	5
0334990L01	0334990L24	-	320	640	860	990	6	5
03341190L01	03341190L24	03341190L613	320	832	1060	1190	6	5

0055

**TWIN**

ALUMINIUM Design: Viefef®

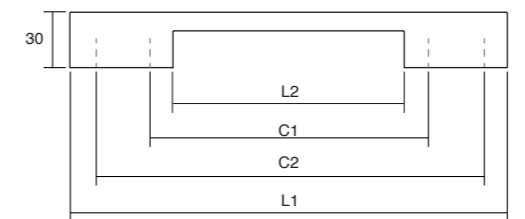

01	21	C1	C2	L1	L2	⬇	⊞
Polished chrome	Brushed chrome						
Cromo brillo	Cromo cepillado						
0055128L01	0055128L21	128	-	152	80	2	25
0055192L01	0055192L21	192	-	216	100	2	25
-	0055224L21	224	-	266	126	2	25
0055256L01	0055256L21	256	-	316	153	2	25
-	0055288L21	288	-	366	178	2	25
-	0055384L21	256	384	416	204	4	25
0055480L01	0055480L21	288	480	516	256	4	25
-	0055576L21	352	576	616	308	4	25
0055672L01	0055672L21	480	672	716	360	4	25

0379 / 0380 / 0382

**STEEP**

ALUMINIUM

Design: Viefte®

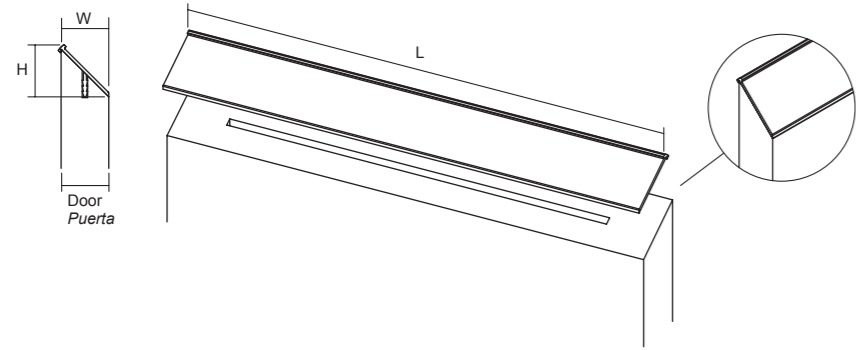

02	24	M2	L	W	H	Door
Anodized bright Anodizado brillo	Stainless steel look Inox look	Matt black Negro mate				Puerta
03793000L02	-	-	3000	17,5	18,5	15 16
03803000L02	03803000L24	03803000LM2	3000	21	21,8	15 18-19
-	03823000L24	-	3000	24	24,8	15 22

0108

**TWISTED**

ZAMAK

Design: Viefte®

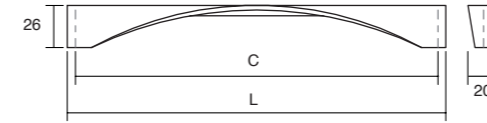

01	23	C	L	↓	☐
Polished chrome Cromo brillo	Brushed nickel Níquel cepillado				
0108160Z01	0108160Z23	160	170	2	25
0108224Z01	0108224Z23	224	234	2	25
0108320Z01	0108320Z23	320	340	2	25

0239

**ARA**

ALUMINIUM

Design: 2J Design

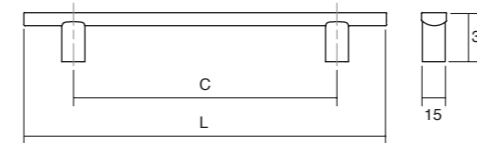

24	C	L	↓	☐
Stain. steel look Inox look				
0239096L24	96	156	2	25
0239192L24	192	252	2	25
0239320L24	320	380	2	25

0343

**GRADA**

ALUMINIUM

Design: Viefte®

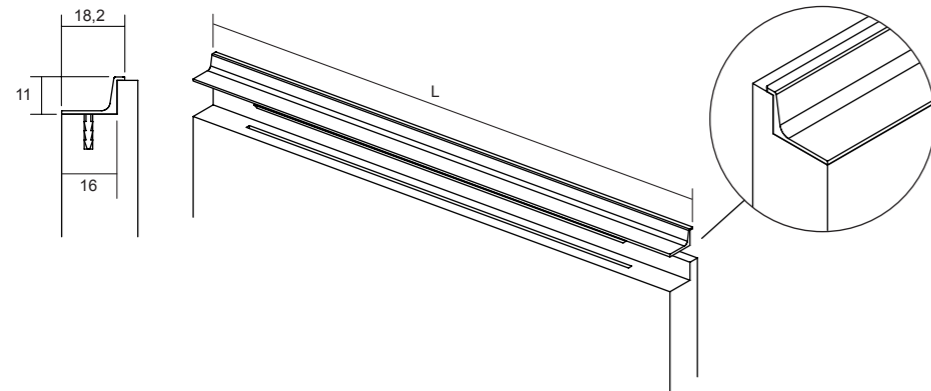

02	04	24	M1	M2	L	☐
Anodized bright Anodizado brillo	Anodized matt Anodizado mate	Stainless steel look Inox look	Matt white Blanco mate	Matt black Negro mate		
-	0343147L04	0343147L24	0343147LM1	0343147LM2	147	15
-	0343197L04	0343197L24	0343197LM1	0343197LM2	197	15
-	0343247L04	0343247L24	0343247LM1	0343247LM2	247	15
-	0343297L04	0343297L24	0343297LM1	0343297LM2	297	15
-	0343347L04	0343347L24	0343347LM1	0343347LM2	347	15
-	0343397L04	0343397L24	0343397LM1	0343397LM2	397	15
-	0343447L04	0343447L24	0343447LM1	0343447LM2	447	10
-	0343497L04	0343497L24	0343497LM1	0343497LM2	497	10
-	0343597L04	0343597L24	0343597LM1	0343597LM2	597	10
-	0343697L04	0343697L24	0343697LM1	0343697LM2	697	10
-	0343797L04	0343797L24	0343797LM1	0343797LM2	797	10
-	0343897L04	0343897L24	0343897LM1	0343897LM2	897	5
-	0343997L04	0343997L24	0343997LM1	0343997LM2	997	5
-	03431197L04	03431197L24	03431197LM1	03431197LM2	1197	5
03433000L02	03433000L04	03433000L24	03433000LM1	03433000LM2	3000	15

0219

**ARROW**

ZAMAK

Design: 2J Design

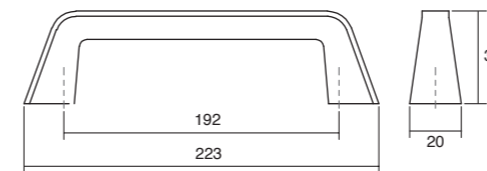

01	23	C	L	↓	☐
Polished chrome Cromo brillo	Brushed nickel Níquel cepillado				
0219192Z01	0219192Z23	192	223	2	25

0230 **THIN** ZAMAK Design: 2J Design

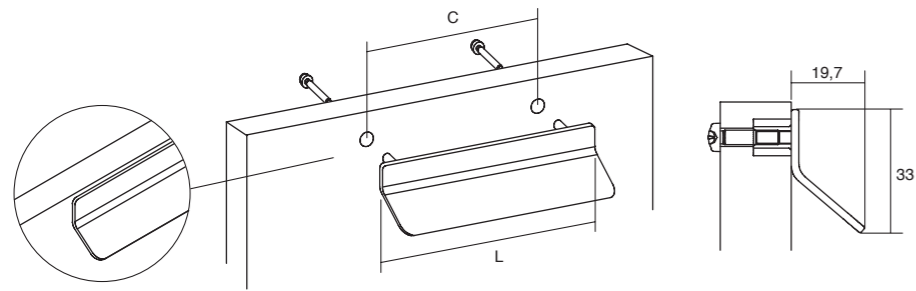

01	23	C	L	↓	☐
Polished chrome <i>Cromo brillo</i>	Brushed nickel <i>Níquel cepillado</i>				
0230064Z01	0230064Z23	64	96	2	25
0230160Z01	0230160Z23	160	192	2	25

0226 **REDO** ZAMAK Design: 2J Design

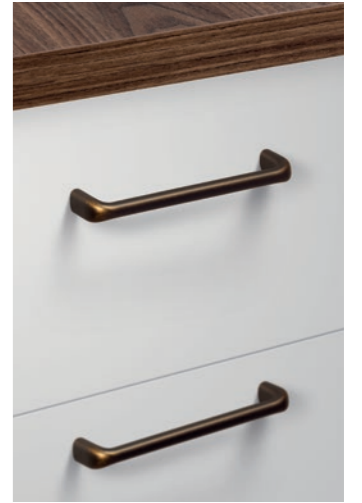
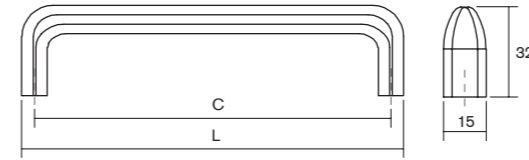

01	23	26	610	614	C	L	↓	☐
Polished chrome <i>Cromo brillo</i>	Brushed nickel <i>Níquel cepillado</i>	Brushed copper <i>Cobre cepillado</i>	Pewter <i>Peltre</i>	Antique Brass <i>Latón antiguo</i>				
0226128Z01	0226128Z23	0226128Z26	0226128Z610	0226128Z614	128	137	2	25
0226192Z01	0226192Z23	0226192Z26	0226192Z610	0226192Z614	192	201	2	25

0410 **BUTTON** ZAMAK Design: Alexis Vivet

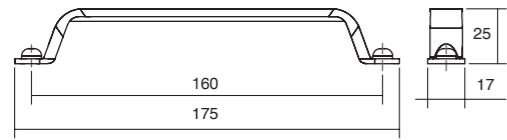

01	610	614	M2	↓	☐
Polished chrome <i>Cromo brillo</i>	Pewter <i>Peltre</i>	Antique Brass <i>Latón antiguo</i>	Matt black <i>Negro mate</i>		
0410160Z01	0410160Z610	0410160Z614	0410160ZM2	2	25

0411 **VERSO** ZAMAK Design: Teruel & Paré

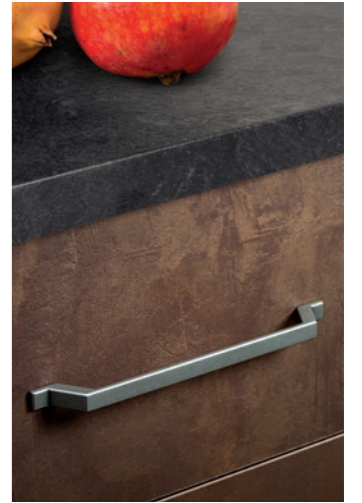
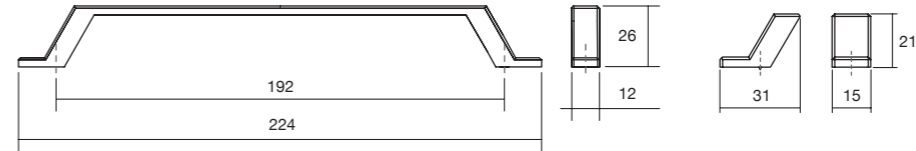

01	23	610	614	↓	☐
Polished chrome <i>Cromo brillo</i>	Brushed nickel <i>Níquel cepillado</i>	Pewter <i>Peltre</i>	Antique Brass <i>Latón antiguo</i>		
0411015Z01	0411015Z23	0411015Z610	0411015Z614	1	25
0411192Z01	0411192Z23	0411192Z610	0411192Z614	2	25

0393 **DUKE** ZAMAK Design: Viefé®

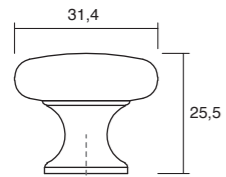

01	23	26	27	66	610	612	614	M1	M2	↓	☐
Pol. chrome <i>Cromo brillo</i>	Brushed nickel <i>Níquel cepill.</i>	Brushed copper <i>Cobre cepillado</i>	Brushed brass <i>Latón cepillado</i>	Antique copper <i>Cobre antiguo</i>	Pewter <i>Peltre</i>	Antique silver <i>Plata antigua</i>	Antique Brass <i>Latón antiguo</i>	Matt white <i>Blanco mate</i>	Matt black <i>Negro mate</i>		
0393031Z01	0393031Z23	0393031Z26	0393031Z27	0393031Z66	0393031Z610	0393031Z612	0393031Z614	0393031ZM1	0393031ZM2	1	25

0405 **RAVIOLO** ZAMAK Design: Balutto Associati

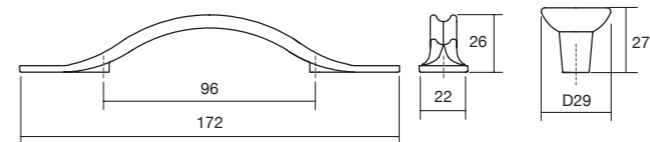

610	614	↓	☐
Pewter <i>Peltre</i>	Antique Brass <i>Latón antiguo</i>		
0405029Z610	0405029Z614	1	25
0405096Z610	0405096Z614	2	25

0394 **AVA** ZAMAK Design: Viefe®

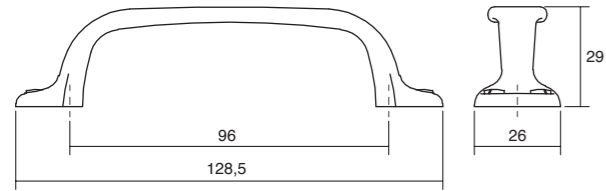

01 Polished Chrome Cromo brillo  
610 Pewter Peltre  
614 Antique Brass Latón antiguo

0394096Z01 0394096Z610 0394096Z614 2 25



0391 **AURA** ZAMAK Design: Viefe®

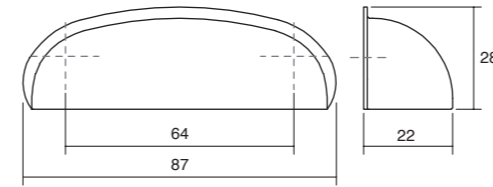

66 Antique copper Cobre antiguo  
612 Antique silver Plata antigua

0391064Z66 0391064Z612 2 25



0390 **PETRA** ZAMAK Design: Viefe®

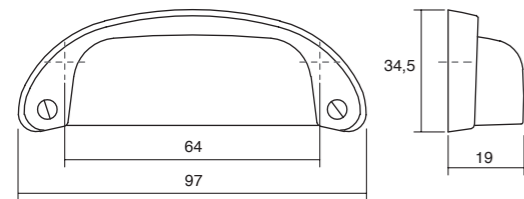

66 Antique copper Cobre antiguo  
612 Antique silver Plata antigua  
M2 Matt black Negro mate

0390064Z66 0390064Z612 0390064ZM2 2 25



0404 **FLEXA** LEATHER + ZAMAK Design: Balutto Associati

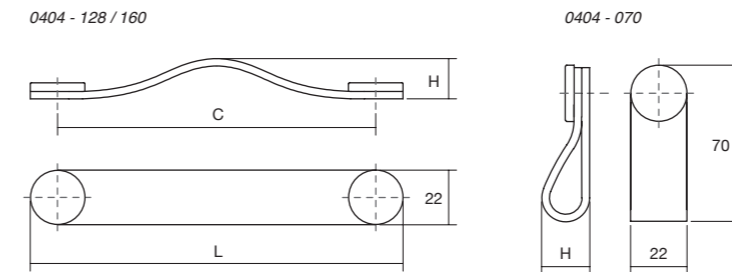

0392 **ORION** ZAMAK Design: Viefe®

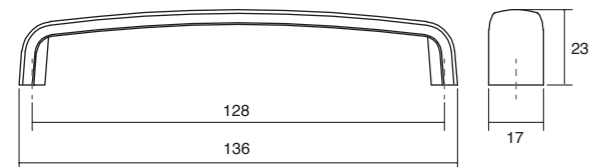

66 Antique copper Cobre antiguo  
612 Antique silver Plata antigua

0392128Z66 0392128Z612 2 25

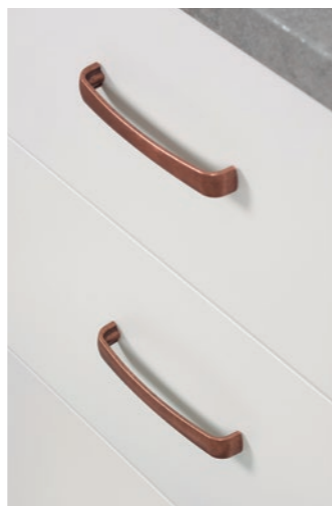

	26 Beige / Beige	36 Brown / Marrón	99 Black / Negro	C	L	H	↓	☐
01 Polished chrome / Cromo brillo	0404070P2601	0404070P3601	0404070P9901	-	70	24	1	25
01 Polished chrome / Cromo brillo	0404128P2601	0404128P3601	0404128P9901	128	150	25	2	25
01 Polished chrome / Cromo brillo	0404160P2601	0404160P3601	0404160P9901	160	182	27	2	25
610 Pewter / Peltre	0404070P2610	0404070P3610	0404070P9910	-	70	24	1	25
610 Pewter / Peltre	0404128P2610	0404128P3610	0404128P9910	128	150	25	2	25
610 Pewter / Peltre	0404160P2610	0404160P3610	0404160P9910	160	182	27	2	25
M2 Black / Negro	0404070P26M2	0404070P36M2	0404070P99M2	-	70	24	1	25
M2 Black / Negro	0404128P26M2	0404128P36M2	0404128P99M2	128	150	25	2	25
M2 Black / Negro	0404160P26M2	0404160P36M2	0404160P99M2	160	182	27	2	25
27 Brass / Latón	0404070P2627	0404070P3627	0404070P9927	-	70	24	1	25
27 Brass / Latón	0404128P2627	0404128P3627	0404128P9927	128	150	25	2	25
27 Brass / Latón	0404160P2627	0404160P3627	0404160P9927	160	182	27	2	25

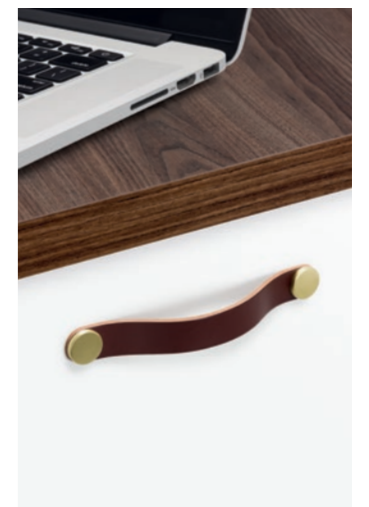

0239 **ARA W** ALUMINIUM + WOOD Design: 2J Design

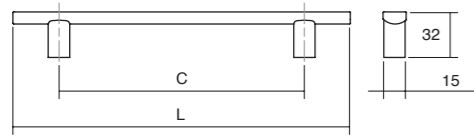

24 + 16	24 + 17	C	L	↓	☐
Stainless steel look + Oak Inox look + Roble	Stainless steel look + Walnut Inox look + Nogal				
0239160N2416	0239160N2417	160	220	2	25
0239224N2416	0239224N2417	224	284	2	25



0326 **TACCO** WOOD Design: Alexis Vivet

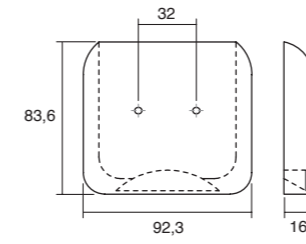

18	19	00	↓	☐
Ash Fresno	Walnut Nogal	Beech raw Haya crudo		
0326032W18	0326032W19	0326032W00	2	25



0340 **BARCCO** WOOD Design: Alexis Vivet

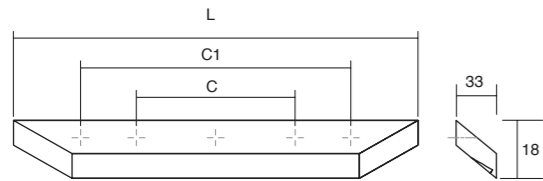

18	19	00	C	C1	L	↓	☐
Ash Fresno	Walnut Nogal	Beech raw Haya crudo					
0340200W18	0340200W19	0340200W00	160	-	200	3	25
0340400W18	0340400W19	0340400W00	320	-	400	3	25
0340600W18	0340600W19	0340600W00	320	480	600	4	25



0166 **ECHO** WOOD Design: Viefe®

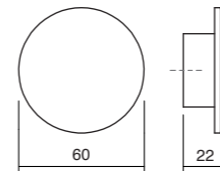

00	02	08	09	↓	☐
Raw brushed Crudo cepillado	White brushed Blanco cepillado	Brown brushed Marrón cepillado	Black brushed Negro cepillado		
0166060W00	0166060W02	0166060W08	0166060W09	1	25



0165 **CALIN** WOOD Design: Viefe®

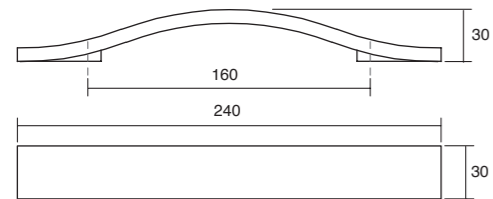

00	02	08	09	↓	☐
Raw brushed Crudo cepillado	White brushed Blanco cepillado	Brown brushed Marrón cepillado	Black brushed Negro cepillado		
0165160W00	0165160W02	0165160W08	0165160W09	2	25



0167 **BALTO** WOOD Design: Viefe®

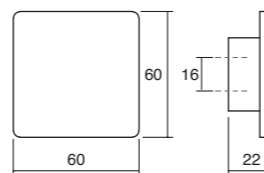

00	02	08	09	↓	☐
Raw brushed Crudo cepillado	White brushed Blanco cepillado	Brown brushed Marrón cepillado	Black brushed Negro cepillado		
0167016W00	0167016W02	0167016W08	0167016W09	2	25



0281 **FLAT** ZAMAK

Design: Oriol Barri

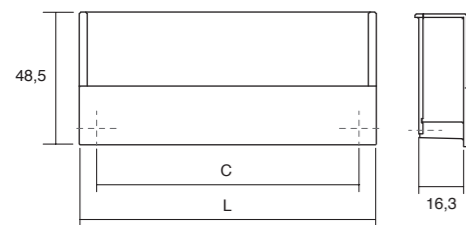

01	23					
Polished chrome	Brushed nickel	C	L	↓	☐	
<i>Cromo brillo</i>	<i>Níquel cepillado</i>					
0281160Z01	0281160Z23	160	174,8	2	25	



0091 **RASO** ZAMAK

Design: Viefe®

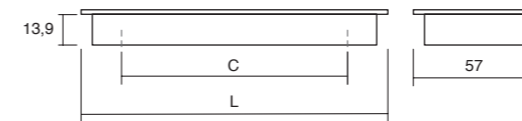

01	23					
Polished chrome	Brushed nickel	C	L	↓	☐	
<i>Cromo brillo</i>	<i>Níquel cepillado</i>					
0091032Z01	0091032Z23	32	70	2	25	
0091108Z01	0091108Z23	108	152,5	2	25	



0243 **LOW ST** ZAMAK

Design: Viefe®

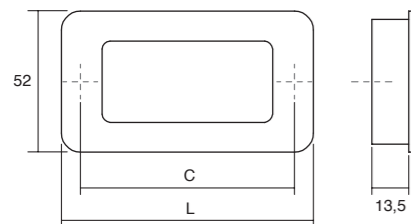

01	23					
Polished chrome	Brushed nickel	C	L	↓	☐	
<i>Cromo brillo</i>	<i>Níquel cepillado</i>					
0243064Z01ST	0243064Z23ST	64	78	2	25	With backplate / Con placa posterior
0243192Z01ST	0243192Z23ST	192	206	2	25	With backplate / Con placa posterior



0208 **DUA** ZAMAK

Design: Viefe®

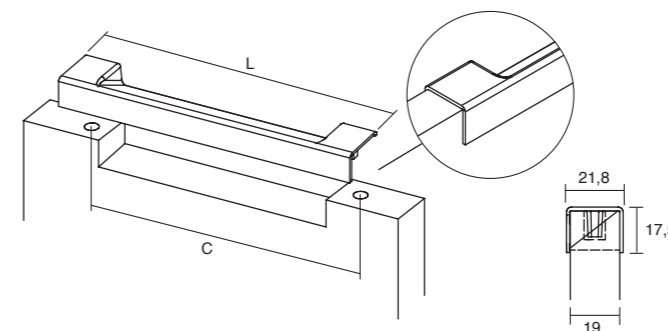

01	23					
Polished chrome	Brushed nickel	C	L	↓	☐	Door
<i>Cromo brillo</i>	<i>Níquel cepillado</i>					<i>Puerta</i>
0208192Z01	0208192Z23	192	210	2	25	19mm



0204 **RADI** STAINLESS STEEL

Design: Viefe®

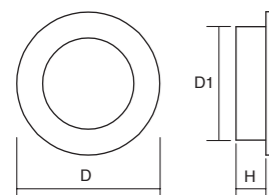

25					
Brushed stain. steel	D	D1	H	↓	☐
<i>Inox cepillado</i>					
0204050S25	50	40	12	25	
0204065S25	65	55	14	25	



0376 **BOXX** ZAMAK

Design: Alexis Vivet

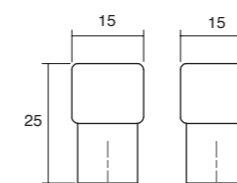

01	11	23	M2		
Polished chrome	Matt chrome	Brushed nickel	Matt black	↓	☐
<i>Cromo brillo</i>	<i>Cromo mate</i>	<i>Níquel cepillado</i>	<i>Negro mate</i>		
0376012Z01	0376012Z11	0376012Z23	0376012ZM2	1	25





0097 **BIN** ALUMINIUM Design: 2J Design

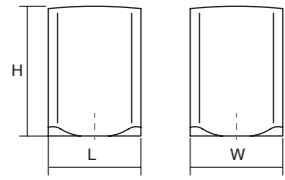

01	21	L	W	H	↓	☐
Polished chrome <i>Cromo brillo</i>	Brushed chrome <i>Cromo cepillado</i>					
0097015L01	0097015L21	15	15	24	1	25
0097020L01	0097020L21	20	20	28	1	25



0009 **PISTON** ZAMAK + ACRYLIC Design: 2J Design

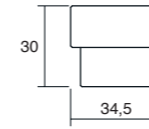

01+22	02+22	↓	☐
White + Brushed nickel <i>Blanco + Níquel cepillado</i>	Black + Brushed nickel <i>Negro + Níquel cepillado</i>		
0009035V0122	0009035V0222	1	25



0065 **SQUARE** ZAMAK Design: Viefe®

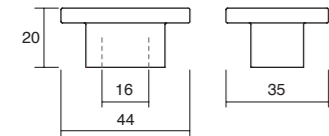

01	11	23	↓	☐
Polished chrome <i>Cromo brillo</i>	Matt chrome <i>Cromo mate</i>	Brushed nickel <i>Níquel cepillado</i>		
0065016Z01	0065016Z11	0065016Z23	2	25



0113 **FRUIT** ZAMAK + ACRYLIC Design: 2J Design

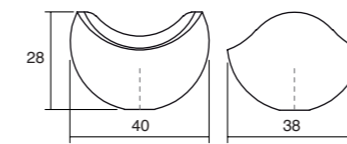

01+01	01+02	01+03	↓	☐
Polished chrome + White <i>Cromo brillo + Blanco</i>	Polished chrome + Black <i>Cromo brillo + Negro</i>	Polished chrome + Lime <i>Cromo brillo + Lima</i>		
0113040V0101	0113040V0102	0113040V0103	1	25



Includes non-twisting tip  
*Incluye punta no giratoria*

0374 **BALL** ZAMAK Design: Alexis Vivet

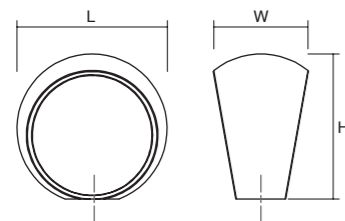

01	23	27	L	W	H	↓	☐
Polished chrome <i>Cromo brillo</i>	Brushed nickel <i>Níquel cepillado</i>	Brushed brass <i>Latón cepillado</i>					
0374024Z01	0374024Z23	0374024Z27	23,3	14,8	22,8	1	25
0374029Z01	0374029Z23	0374029Z27	29,5	18,3	28,8	1	25



0129 **BLOK** ZAMAK + ACRYLIC Design: Viefe®

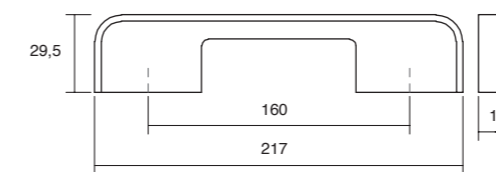

23+01	23+02	↓	☐
Brushed nickel + Matt white <i>Níquel cepillado + Blanco mate</i>	Brushed nickel + Matt black <i>Níquel cepillado + Negro mate</i>		
0129160V2301	0129160V2302	2	25



0369 **RITTA** ALUMINIUM Design: Teruel & Paré

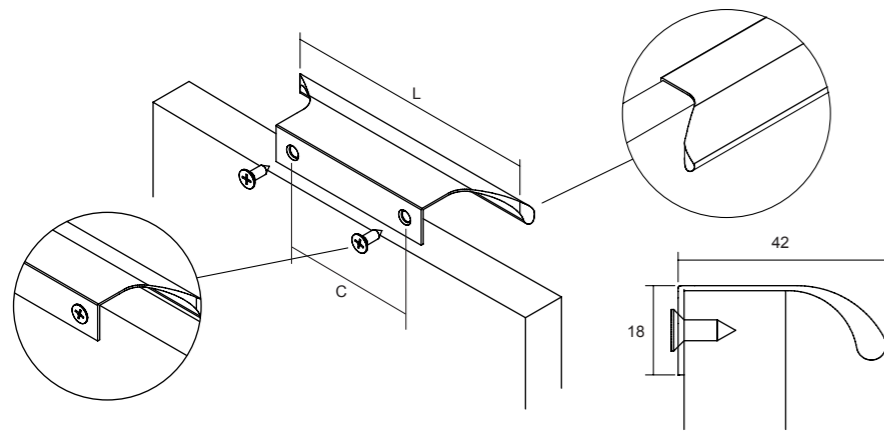

01	09	24	C	L	↓	☐
Polished chrome <i>Cromo brillo</i>	Matt black <i>Negro mate</i>	Stainless steel look <i>Inox look</i>				
0369064L01	0369064L09	0369064L24	64	130	2	25
0369128L01	0369128L09	0369128L24	128	260	2	25

0076 **FORT** STAINLESS STEEL Design: Viefte®

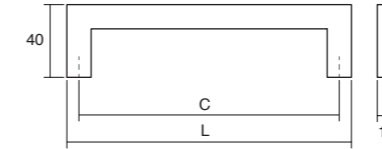

25	C	L	↓	☐
Brushed stainless steel <i>Acero inox. cepillado</i>				
0076128S25	128	143	2	25
0076160S25	160	175	2	25
0076192S25	192	207	2	25
0076256S25	256	271	2	25
0076320S25	320	335	2	25
0076392S25	392	407	2	25
0076492S25	492	507	2	25
0076592S25	592	607	2	25
0076692S25	692	707	2	25



0249 **FERRI** STAINLESS STEEL Design: Viefte®

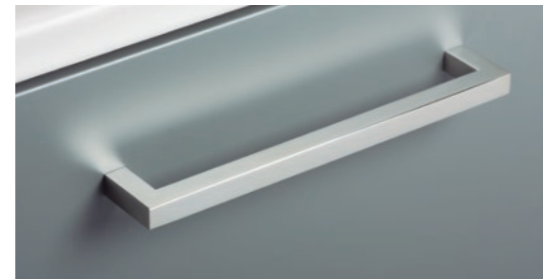
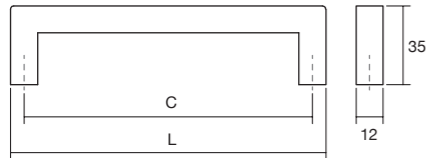

02	25	C	L	↓	☐
Polished stainless steel <i>Inox brillo</i>	Brushed stainless steel <i>Inox cepillado</i>				
0249128S02	0249128S25	128	140	2	25
0249160S02	0249160S25	160	172	2	25
0249192S02	0249192S25	192	204	2	25
0249320S02	0249320S25	320	332	2	25
0249512S02	0249512S25	512	524	2	25

0083 **TUB** STAINLESS STEEL Design: Viefte®

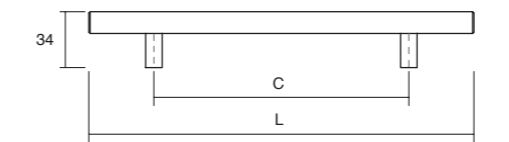

25	C	L	↓	☐
Brushed stainless steel <i>Inox cepillado</i>				
0083128S25	128	192	2	25
0083160S25	160	224	2	25
0083192S25	192	256	2	25

0092 **GLASS** ZAMAK + GLASS Design: Viefte®

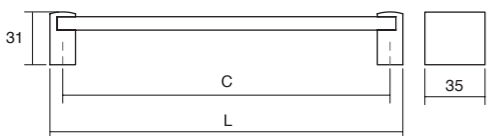

01 + V1	C	L	↓	☐
Polished chrome + Temper glass <i>Cromo brillo + Vidrio temperado</i>				
0092035C01V1	-	30	2	25
0092160C01V1	160	175	2	25
0092192C01V1	192	207	2	25
0092320C01V1	320	335	2	25

0312 **ARKO** ALUMINIUM Design: Viefte®

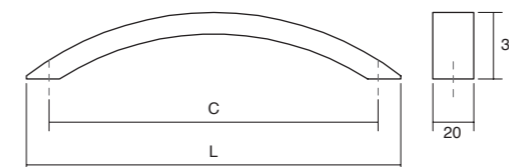

24	C	L	↓	☐
Stain. steel look <i>Inox look</i>				
0312160L24	160	186	2	25
0312192L24	192	218	2	25
0312256L24	256	292	2	25

0064 **KOMBI** STAINLESS STEEL Design: Viefe®

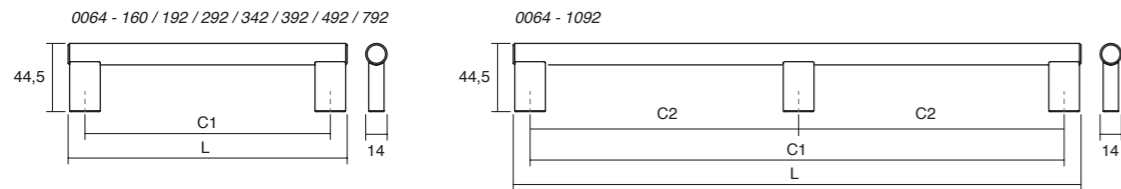

25  
Brushed stainless steel  
*Inox cepillado*

	C1	C2	L	↓	☐
0064160S25	160	-	182	2	25
0064192S25	192	-	214	2	25
0064292S25	292	-	314	2	25
0064342S25	342	-	364	2	25
0064392S25	392	-	414	2	25
0064492S25	492	-	514	2	25
0064792S25	792	-	814	2	25
00641092S25	1092	546	1114	3	25



0114 **HOOK** ZAMAK Design: 2J Design

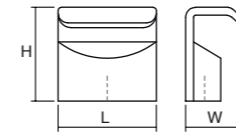

01 23  
Polished chrome Brushed nickel  
*Cromo brillo Níquel cepillado*

	L	W	H	↓	☐
0114030Z01	0114030Z23	30	20	28	1 25

Includes non-twisting tip / Incluye punta anti-giro



0060 **STEP** ALUMINIUM Design: Viefe®

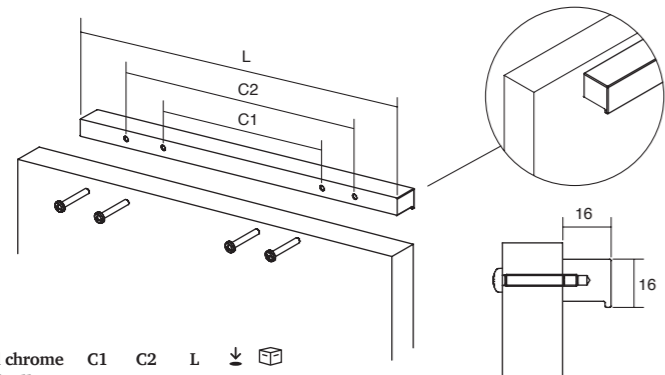

01  
Polished chrome  
*Cromo brillo*

	C1	C2	L	↓	☐
0060032L01	32	-	80	2	25
0060096L01	96	-	150	2	25
0060160L01	160	-	250	2	25
0060224L01	224	-	350	2	25
0060480L01	480	240	550	3	25



0169 **ONE** ZAMAK Design: Viefe®

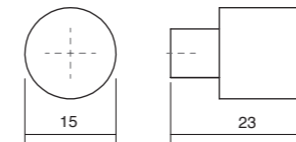

01 11 23  
Polished chrome Matt chrome Brushed nickel  
*Cromo brillo Cromo mate Níquel cepillado*

			↓	☐
0169015Z01	0169015Z11	0169015Z23	1	25



0315 **ZAPA** ZAMAK Design: Oriol Barri

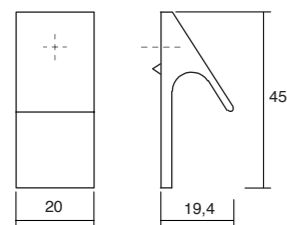

01 11 23  
Polished chrome Matt chrome Brushed nickel  
*Cromo brillo Cromo mate Níquel cepillado*

			↓	☐
0315020Z01	0315020Z11	0315020Z23	1	25

Includes non-twisting tip / Incluye punta no giratoria



0035 **ACER** STAINLESS STEEL Design: 2J Design

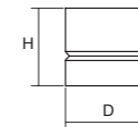

25  
Brushed stain. steel  
*Inox cepillado*

	D	H	↓	☐
0035018S25	18	23	1	25
0035023S25	23	25	1	25
0035028S25	28	27	1	25



6005 **FONDA** ALUMINIUM

Design: Viefe®

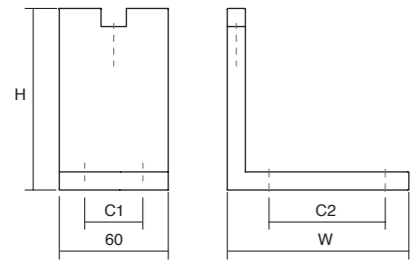

01	24	29 <b>NEW!</b>	30	C1	C2	W	H	↓	☐
Polished chrome <i>Cromo brillo</i>	Stainless steel look <i>Inox look</i>	Brushed brass dark <i>Latón oscuro cepillado</i>	Brushed black <i>Negro cepillado</i>						
6005100L01	6005100L24	6005100L29	6005100L30	32	44	80	100	4	24
6005150L01	6005150L24	6005150L29	6005150L30	32	44	80	150	4	24
6005200L01	6005200L24	6005200L29	6005200L30	32	64	100	200	4	24

6003 **JAZZ** ALUMINIUM

Design: Viefe®

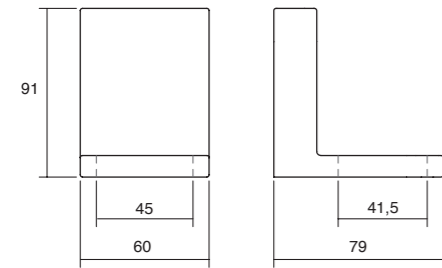

01	P1	↓	☐
Polished chrome <i>Cromo brillo</i>	Chrome look <i>Cromo look</i>		
6003045Z01	6003045ZP1	4	24

Model	Product pag	Tech info pag
0009 PISTON	221	273
0035 ACER	231	277
0053 DINO	164-165	254
0055 TWIN	176-177	261
0056 U en blanc	40-41	240
0056 U	42-43	240
0060 STEP	229	276
0064 KOMBI	229	276
0065 SQUARE	219	272
0073 TAP	112-113	250
0076 FORT	227	275
0077 ANGLE	122-123	252
0083 TUB	228	275
0091 RASO	214	271
0092 GLASS	227	274
0094 HIDE	100-101	248
0097 BIN	218	272
0105 NEST	106-107	249
0108 TWISTED	178	263
0109 GRAF	82-83	247
0113 FRUIT	222	273
0114 HOOK	230	277
0117 CURVE	148-149	258
0119 WAVE	102-103	249
0127 JEY	12-13	237
0129 BLOK	223	273
0139/0140 LINEAR	150-151	258
0162 KADO	173	251
0163 JEY2	14-15	237
0165 CALIN	206	268
0166 ECHO	208	269
0167 BALTO	209	269
0168 COMO (shiny)	18-19	238
0168 COMO	20-21	238
0169 ONE	231	277
0195 SENSE	116-117	251
0204 RADI	213	270
0206 ARCH	172	256
0208 DUA	215	271
0219 ARROW	180	263
0226 REDO	186-187	265
0230 THIN	181	264
0235 CLOS	108-109	249
0239 ARA	179	263
0239 ARA W	200-201	268
0241 ROMA curt	44-45	241
0241 ROMA tots	46-47	241
0243 LOW ST	212	270
0249 FERRI	226	274
0250/0251/0253 FORMA	155	260
0254/0255 NOMA	154	259
0281 FLAT	210-211	270
0301 SENSE MINI	114-115	250
0306 KARES	171	255
0311 TAMM	158	261
0312 ARKO	228	275
0315 ZAPA	230	276
0322 CUTT	168-169	257
0326 TACCO	207	269
0334 BRIKK	156-157	260
0340 BARCCO	202-203	268
0341 ASI	134-135	252

0343 GRADA	159	261
0366 CUBIC	110-111	250
0369 RITTA	226	274
0370 SMEE	170	255
0372 ONA curt	138-139	256
0372 ONA tots	140-141	256
0373 NICK	166-167	254
0374 BALL	220	272
0375 VANN curt	142-143	257
0375 VANN llarg	144-145	257
0376 BOXX	216-217	271
0379/0380/0382 STEEP	162-163	262
0390 PETRA	195	266
0391 AURA	197	267
0392 ORION	196	266
0393 DUKE	184-185	264
0394 AVA	194	266
0404 FLEXA	198-199	267
0405 RAVIOLO	192-193	265
0410 BUTTON	182-183	264
0411 VERSO	188-189	265
0430 GRAF MINI	80-81	246
0434/0435/0436 VECTOR	152-153	259
0444 PEAK nansa	126-127	254
0444 PEAK pom	128-129	254
0446 ESTE	92-93	245
0447 BELLA	94-95	247
0449 HEXXA curt	96-97	248
0449 HEXXA llarg	98-99	248
0451 FELTRE	118-119	247
0452 BRAVE	124-125	253
0457 BACKK	130-131	251
0459 LINES	84-85	242
0465 STRATT	136-137	253
0467 SKALA	86-87	243
0480 NICE	88-89	244
0486 GRAF BIG nansa	74-75	246
0486 GRAF BIG pom	76-77	246
0486 GRAF BIG llargs	78-79	246
0487 PURA	16-17	236
0489 BOL	50-51	241
0490 SWITCH	28-29	239
0494 LAND caçoleta	58-59	243
0494 LAND pom	60-61	243
0495 FLOID	6-7	236
0496 BAU	8-9	236
0497 DIABOLO	22-23	238
0499 ROUND	26-27	238
0503 WALLACE	48-49	241
0506 FIRM curt	62-63	244
0506 FIRM llarg	64-65	244
0507 OBLONG nansa	52-53	242
0507 OBLONG pom	54-55	242
0511 RAIL curt	34-35	240
0511 RAIL tots	36-37	240
0516 PENDANT nansa	66-67	245
0516 PENDANT tots	68-69	245
0518 WAY curt	30-31	239
0518 WAY tots	32-33	239
6003 JAZZ	232	278
6005 FONDA	70-71	278

---

# NOTES

---



---

# NOTES

---



---

# NOTES

---





---

# NOTES

---



---

**Viefe**<sup>®</sup> handles

---



[viefe.com/news](http://viefe.com/news)  
[facebook.com/viefe](https://facebook.com/viefe)  
[instagram.com/viefehandles](https://instagram.com/viefehandles)



[info@viefe.com](mailto:info@viefe.com)  
T +34 938584029

C/ Dels Traginers 2  
Sant Pere de Torelló  
08572 Barcelona, Spain